



inTouch

WIRELESS MONITORING SYSTEM

TYPE IT1000

WIRELESS MONITORING SYSTEM for FLAME-MONITOR MicroM and BurnerLogix FLAME SAFEGUARD CONTROLS

DESCRIPTION

The Fireye® inTouch Type IT1000 provides continuous monitoring of the Flame-Monitor, MicroM and BurnerLogix Y & Z flame safeguard controls. In the event of a lockout, the inTouch system reports the condition causing the lockout and also the make, model and location of the equipment over the wireless GSM cellular network using a wide variety of delivery methods, i.e. telephone, fax, e-mail, pager (alphanumeric, numeric). The user also configures which individuals will receive a message regarding certain operating conditions.

The inTouch system also provides additional inputs to monitor up to 4 each of both dry contact inputs and AC powered input. The inputs can be connected to additional ancillary devices located in a boiler room that are considered critical to proper operation. These may include compressor out of range, water on the floor, float levels, freeze conditions, etc. The inTouch system can be configured to provide distinct messages for each monitored point. Two each of the dry contact and AC voltage inputs can be configured to alarm on contact close or open or on voltage present or absent.

Also, every 24 hours, the inTouch system will transmit to the server message center information about itself and the controls connected. This information transmitted contains system hours, burner cycles, burner hours and total lockouts.

The inTouch Wireless Monitoring System provides many operational characteristics including:

Immediate notification of lockout

- 24/7 monitoring
- Direct interface to Flame-Monitor, MicroM or BurnerLogix
- Utilizes cellular network – GSM
- Monitors up to 10 Flame Safeguard Devices
- Monitors 4 dry-contact inputs, selectable alarm on open or close
- Monitors 4 AC inputs, selectable alarm on no voltage or voltage
- Selectable 4800/9600 baud rate
- Battery back-up
- Service button, test message
- 24 Hour heartbeat status
- User configurable messages
- NEMA 4 housing
- Low monthly service charge

SPECIFICATIONS

Power:

Input Voltage: 85 - 120VAC 50/60 Hz

Battery Backup: 9.6 VDC NICAD

Environment

Operating Temperature: -40 to 160°F (-40 to 70°C)

Storage Temperature: -40 to 160°F (-40 to 70°C)

Enclosure

Type: NEMA-4 suitable for outdoor mounting

Dimensions: 7 1/8"W x 9 5/8"H x 3 1/2"D (18 x 24.5 x 8.9cm)

Material: UV Resistant ABS Grey

Knockouts: 3 bottom, 3 rear (1/2", 3/4" concentric)

Inputs

**RS485,
Modbus RTU Protocol:** 4800/9600 baud, selectable

4 AC Inputs: 24-120VAC; 3mA

4 Switch: Dry contact closures

Radio

Transmit: 900 - 1800 MHz

Receive: 900 - 1800 MHz

Output: 1.5 Watts

Antenna: Quad Band GSM Antenna

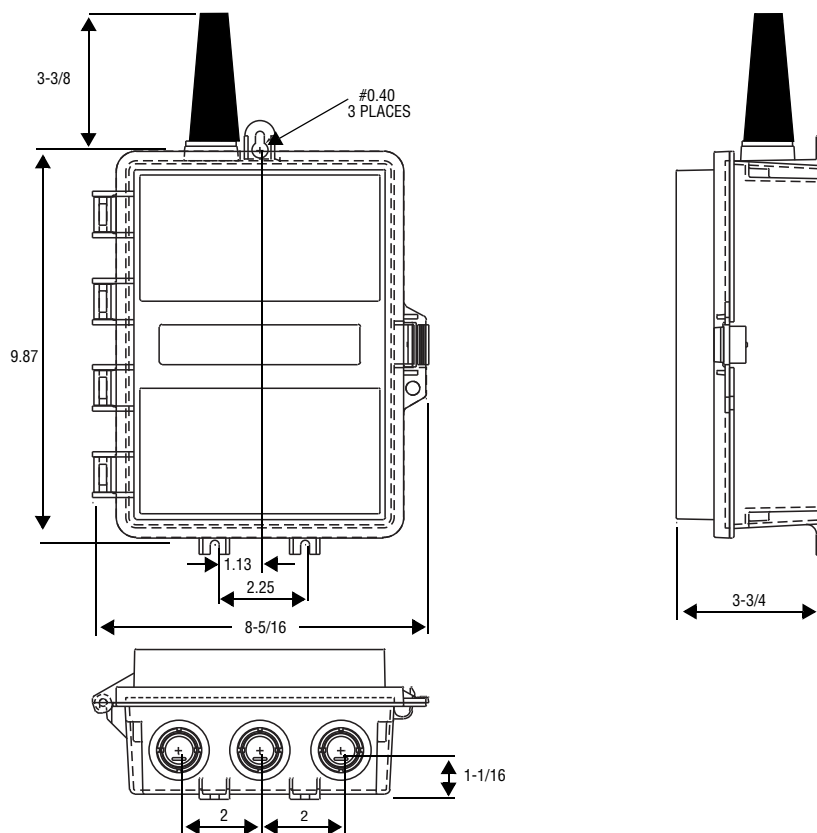

ORDERING INFORMATION

PART NUMBER	DESCRIPTION
IT1000	Monitor up to 10 Flame-Monitors, MicroM or BurnerLogix Y & Z controls, 4 dry-contact, 4 AC input. Complete with 3 Quad Band GSM antenna and communication cable.

Table 1:

ACCESSORIES

PART NUMBER	DESCRIPTION
N018032-10	Remote Quad Mount Antenna without mounting kit (includes 10 ft coax cable)
N018040-KIT	Remote Quad Mount Antenna with mounting kit (includes 10 ft coax cable)
N200233-00	Remote mount U bolt - 1/2" OD pipe size (included in remote mounting kit)
N250339-00	Remote mounting bracket (included in remote mounting kit)
59-509-10,-15,-20,-25	Coax cable extension
ED-512-2,-4,-8	Cable with RJ12 connector used to connect BurnerLogix and Flame-Monitor to ED-610
ED-610	Telephone jack adapter board for multi-dropping controls

FCC WARNING



WARNING: This equipment generates, uses, and radiates radio frequency energy and if not installed and used in accordance with the instructions manual, may cause interference to radio communications. It has been tested and found to comply with the limits for a Class A computing device pursuant to Subpart J of Part 15 of FCC Rules, which are designed to provide reasonable protection against such interference when operated in a commercial environment. Operation of this equipment in a residential area is likely to cause interference. If this is the case, the user, at his own expense, will be required to take whatever measures may be required to correct the interference.

The inTouch System continuously monitors each Flame-Monitor, MicroM and/or BurnerLogix connected by requesting its status using modbus protocol. Up to 10 Fireye controls can be connected to the inTouch System and a poll to each address is made once per second. If the Fireye control reports that it is in a lockout condition or if the control fails to report, the inTouch immediately transmits this information to the Fireye message center. The message center then transmits this specific information to the destination previously configured by way of several different methods. The methods include telephone, fax, e-mail, pager (alphanumeric, numeric).

For proper operation, the inTouch System must be installed and then configured over the Fireye web-site, www.fireye.com. Each inTouch system is shipped with a designated base address. This address is used as the base reference for all Fireye controls subsequently connected. When attaching Fireye controls, each control must have a unique address within the range of 0 through 9. When configuring the inTouch over the web-site, the device installed will be the base address of the inTouch plus the unit address of the Flame-Monitor, MicroM or BurnerLogix control. For example, if the inTouch base address was 330 and three (3) controls with unit address of 0, 1, and 4 were being connected, the devices installed on the web-site would be 330 (330 + 0), 331 (330 + 1) and 334 (330 + 4). The ancillary dry-contact or AC inputs are attached to the base address, by default.

The lockout message transmitted is the same message the Flame-Monitor, MicroM or BurnerLogix Y & Z would have on its local display. Refer to bulletin E-1101, MC-5000 BL-1001 and /or BLZ-1001 for lockout message information and description. If an E300 Expansion Module is used with the Flame-Monitor or a YZ300 is used with the BurnerLogix, the lockout message pertaining to the E300 or YZ300 lockout will be transmitted. Additionally, any lockout message can be re-programmed on the message server to match the user's application.

Each inTouch unit is limited to 40 messages per day and a maximum frequency of 1 message per minute. Up to 10 alarm messages can be stacked, pending transmission.



INSTALLATION

Connecting the Antenna

- A Quad band GSM antenna is provided with the unit. Optional high gain antennae (see ACCESSORIES) can be ordered if the site in question has weak cell coverage.
- The antenna connections on the enclosure are factory installed to prevent water from entering the enclosure.

DO NOT change any of these existing connections.

- Simply screw either antenna to the connector (see Figure 1) on the top of the enclosure. Be sure the connection is tight.

Startup Procedure

- Take the transmitter to the area where the equipment to be monitored is located.
- The transmitter will be able to send messages in locations where GSM cell phones will work. If the equipment is in an area where an GSM cell phone cannot get a signal, it is unlikely the transmitter will be able to get a signal. (*NOTE: A remote antenna is available, see next section*).
- Plug in the battery pack into the battery pack connector (see below). Connect AC power to the appropriate terminals located in the lower right corner.
- The transmitter will begin a startup routine. The startup time will vary but may last up to several minutes as the transmitter establishes a connection to a cell site and registers a message.
- During the startup routine, the Signal Strength Indicator 7-segment LED display segments will rotate. Initially, the middle display segment will not be lit. When the middle segment comes on, the transmitter has successfully completed the first half of the startup routines.

Dipswitch Settings

The inTouch unit contains 4 user configurable dipswitches. Some dipswitch settings take effect during the power up initialization sequence. Changing a dipswitch on the fly may require a power on/off sequence.

SWITCH	OFF	ON
ONE (1)	Do not report end of lockout	Report end of lockout
TWO (2)	4800 Baud Rate	9600 Baud Rate
	Note: All connected controls must have the same baud rate.	
THREE (3)	For dry contact inputs 3 & 4 , alarm on close	For dry contact inputs 3 & 4, alarm on open
FOUR (4)	For voltage inputs 7 & 8, alarm with voltage present	For voltage inputs 7 & 8, alarm with no voltage present

FIGURE 1.

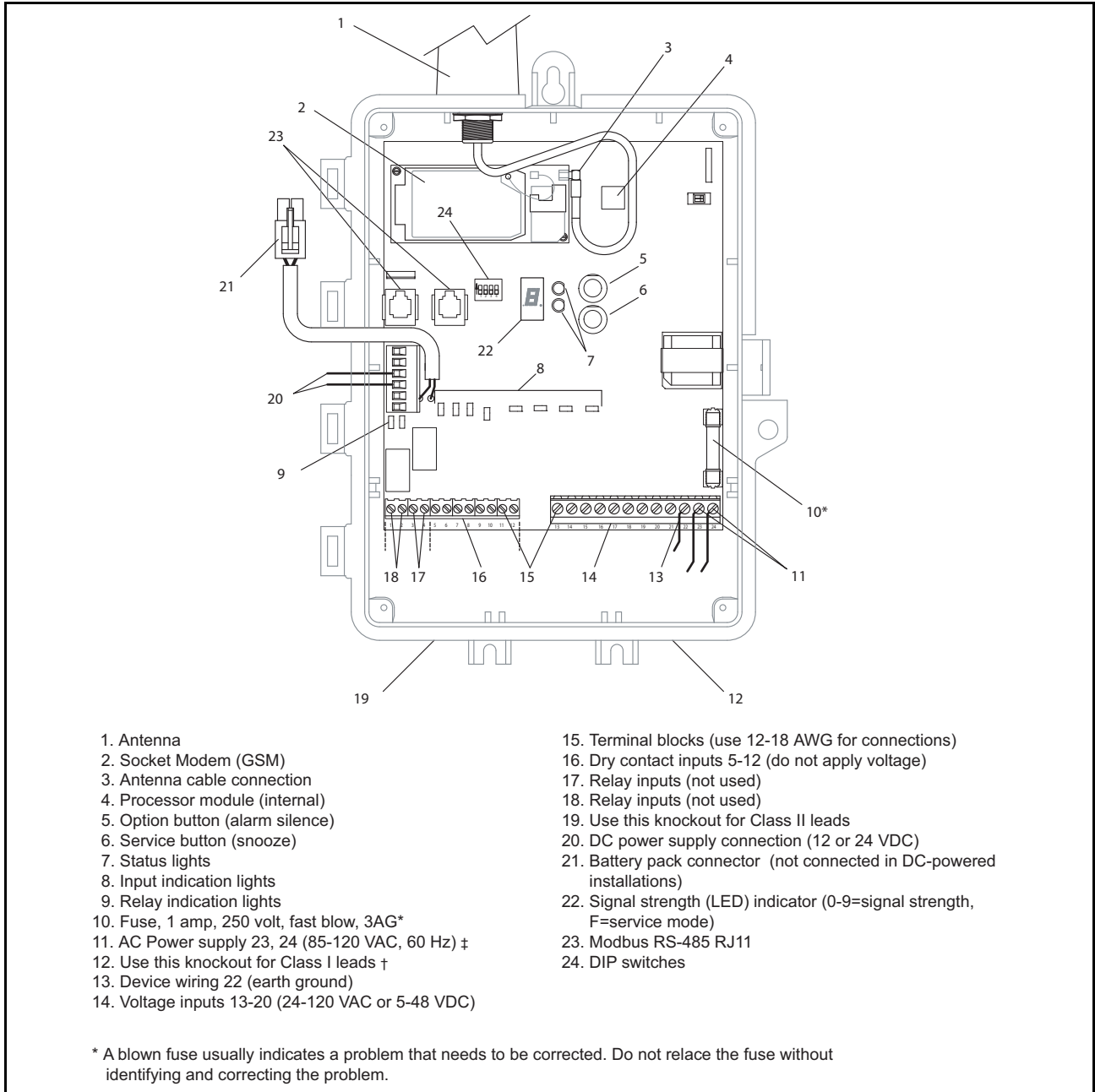

Checking Cell Coverage

- Once the startup procedure is complete, the Signal Strength Indicator display will show the cell signal strength the transmitter registers at its current location.
- The cell signal strength can range from 0 to 9.
- The higher the signal strength number, the better the signal.
- A signal strength less than 3 will not provide reliable message transmission. A remote antenna may be required.



Checking Fireeye Service

- A coverage map is available at the Fireeye web site (www.fireeye.com) under *Coverage Maps*. Simply enter the zip code where you wish to install the transmitter to determine if coverage is available.
- The transmitter sends out a sample message and then waits for a return signal to determine if Fireeye service is available at this site.
- If the transmitter registers Fireeye coverage, then the yellow status light (see below) will flash once per second and the signal strength will be displayed.

Location

- The transmitter can be located either indoors or outside.
- Walk around the equipment or the equipment room with the transmitter powered by the battery pack.
- Place it in several sample mounting locations and check the signal strength.
- If planning to mount the transmitter directly on a piece of equipment, check locations where the antenna rises above or is directed away from the equipment.
- Once the mounting location with the strongest (highest number) signal strength is found, remove the battery pack connection.

Mounting

- Choose a surface which is flat and strong enough to hold the transmitter.
- Antenna must clear the top of the equipment by 2 inches minimum.
- The temperature range the transmitter will experience should not exceed -40°F to 140°F (-40°C to 60°C).
- The transmitter enclosure has one keyhole mounting tab extending from the top of it and two mounting tabs extending underneath. Use all three tabs to secure the unit.
- **DO NOT** drill any holes into or through the enclosure.
- Filed wiring to the inputs must be a minimum of AWG and a maximum of 12 AWG.

Wiring Guidelines

- Remove the black inside cover which is secured with a screw at each corner of the enclosure.
- The Input terminals and Lights will now be visible.
- The enclosure is equipped with 6 knockouts. **DO NOT** make any other holes in the enclosure.
- All Class 1 wiring (AC input wiring) should enter the enclosure through a different knockout from Class 2 wiring (dry contact, communication). Refer to the NEC handbook
- After removing a knockout, seal it with a watertight fitting if the transmitter is being mounted outdoors.

Power Connections

- The rightmost three (3) input terminals are for the power connection.
- Whenever possible, power the transmitter from the same source as the equipment is powered. This will ensure the Power Loss message will occur when the equipment *and* the transmitter lose power.
- Connect back-up battery before wiring main power.
- The transmitter can accept an input voltage range from 85 to 120VAC, 50/60Hz.

Connecting a Remote Antenna

- Remote antenna mounting kits are also available. Extension cables are available in 10, 15 20 and 25 ft. increments, but we do not recommend more than a 50 ft. extension. Please check www.fireeye.com or contact the factory.
- The antenna connections on the enclosure are factory installed to prevent water from entering the enclosure. **DO NOT** change any of these existing connections. Disconnect the standard antenna cable from the radio when installing a remote antenna.

Record Equipment Information

- Either fill in the enclosed MONITORED EQUIPMENT I.D. CARD with the fields described below or call your home office with all the following information:
- The *Location Name* for the piece of equipment being monitored.
- The exact *Street Address*, and the *City, State*, and *Zip code* where the transmitter is located.
- The *Local Contact Phone* and *Name* should be the phone number and name of the person(s) who would need to be contacted to gain access to this transmitter.
- The *Device ID* number located on the black protective cover inside the transmitter. This is also preprinted on the INSTALLATION card.
- The *Equipment Name* for the piece of equipment being monitored. Try to be as specific as possible, especially if there are multiple pieces of equipment which will have transmitters installed at a single site. Possible examples are North Roof Top AC, Boiler-5, Store A Refrigeration 3, etc.
- The *Equipment Manufacturer, Model*, and *Serial Number*. This information should be sufficient to identify repair or replacement parts before a service person is dispatched to the site.







IMPORTANT: If this transmitter has not been configured previously, DO NOT leave the site without recording the Device ID number. Without this number, the device cannot be configured at the web site.



Testing



- To complete the test, the transmitter must be configured at the Fireeye web site (see Configuring the Device Messaging section). Note that while the following test is recommended, the transmitter will send out a Heartbeat message every night. Therefore, it is possible to wait until the next morning to determine if the transmitter sent out a message.
- The yellow status light should be flashing once per second (see Figure 2 on page 7). This indicates the transmitter registers service, is available and is ready to send. The green status light should not be on.
- **Press the Service Button and then release it.**
- The yellow light should now come on. The green light will flash several times. When the green light flashes quickly for approximately 2 seconds, the message has been sent.
- After the message has been successfully sent, the green light will once again be off, and the yellow light should flash every second showing the transmitter is ready to send another message.
- Check the Fireeye website to be sure the message was received.

FIGURE 2.

		STATUS LIGHTS	
YELLOW		OFF	No Service Available
GREEN		OFF	

YELLOW		FLASHING Once/Second	Service Available, Ready to Transmit
GREEN		OFF	

YELLOW		ON	Transmitting Message
GREEN		FLASHES Once or Twice	

YELLOW		ON	Successful Transmission
GREEN		FLASHES 2 Second Rapidly	

Connection to Fireye Controls

Each Flame-Monitor programmer module, engineering code 38 or greater for EP modules and engineering code 4 or greater for EPD modules, comes standard with modbus protocol. The MicroM control requires having the proper daughter board installed into the chassis. Refer to bulletin E-1101, MC-5000, BL-1001 and BLZ-1001 respectively for more information. Connection to the Flame-Monitor and BurnerLogix requires the use of an ED512 cable and ED610 multiport adapters. The MicroM daughter board comes equipped with a terminal block for easy connection to twisted shielded cable. The Flame-Monitor and MicroM controls are fixed at 4800 baud. The BurnerLogix has selectable baud rates. All connected devices must have the same baud rate.

Flame-Monitor Hookup

- It is assumed the Flame-Monitor is mounted in a burner cabinet remote from the inTouch device. Refer to Figure 6 on page 10 for an illustration overview.
- Plug the ED512 cable into either of the telephone style jacks located in the upper left corner of the EP or EPD programmer module. Refer to Figure 3 on page 8
- Connect the other end of the ED512 into the mating connector located on the ED610.
- In accordance with local wiring codes, connect the twisted shielded pair (Belden P/N 8761) to terminals 9 and 10 of the ED610 adapter and run the cable to either the next device to be multi-dropped or to the inTouch device. Refer to Figure 6 on page 10 for suggested wiring diagram.
- Feed the cable into one of the knockout locations under the protective cover.
- Splice the twisted shielded cable onto a telephone style connector using the black (A) and yellow (B) wires. Plug the RJ11 type connector in either communication port of the inTouch device.
- Replace the protective plastic cover.
- Configure the unit address of the Flame-Monitor.
- Set dipswitch 2 on inTouch to 4800 baud.
- Verify communications.

FIGURE 3. FLAME MONITOR CONECTORS

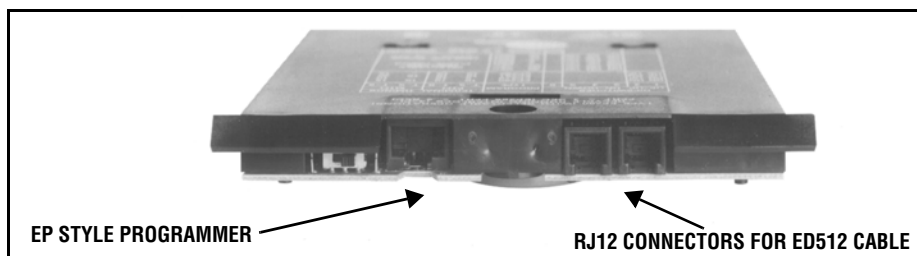

MicroM Hookup

It is assumed the MicroM is mounted in a burner cabinet remote from the inTouch device.

- In accordance with local wiring codes, connect the twisted shielded pair (Belden P/N 8945) to the appropriate terminals located on the MicroM daughter board.

FIGURE 4.

MICROM DAUGHTER BOARD

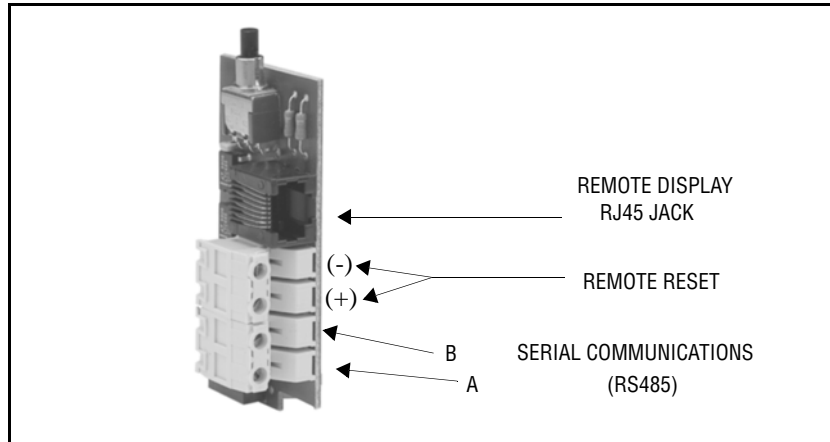

- Run the cable to either the next device to be multi-dropped or to the inTouch device.
- Feed the cable into one of the knockout locations under the protective cover.
- Splice the twisted shielded cable onto a telephone style connector using the black (A) and yellow (B) wires. Plug the RJ11 type connector in either communication port of the inTouch device.
- Replace the protective plastic cover.
- Configure the unit address of the MicroM.
- Set dipswitch 2 on inTouch to 4800 baud.
- Verify communications.

BurnerLogix Hookup

- It is assumed the BurnerLogix is mounted in a burner cabinet remote from the inTouch device. Refer to Figure 6 on page 10 for an illustration overview.
- Plug the ED512 cable into either of the telephone style jacks located in the underside of the YB110 or ZB110 module. Refer to Figure 5 on page 10
- Connect the other end of the ED512 into the mating connector located on the ED610.
- In accordance with local wiring codes, connect the twisted shielded pair (Belden P/N 8761) to terminals 9 and 10 of the ED610 adapter and run the cable to either the next device to be multi-dropped or to the inTouch device. Refer to Figure 6 on page 10 for suggested wiring diagram.
- Feed the cable into one of the knockout locations under the protective cover.
- Splice the twisted shielded cable onto a telephone style connector using the black (A) and yellow (B) wires. Plug the RJ11 type connector in either communication port of the inTouch device.
- Replace the protective plastic cover.
- Set baud rate on inTouch dipswitch 2 to match the baud rate of BurnerLogix controls. (Note: All devices must be the same baud rate).
- Configure the unit address of the BurnerLogix.
- Verify communications.

FIGURE 5. BURNERLOGIX CONNECTORS

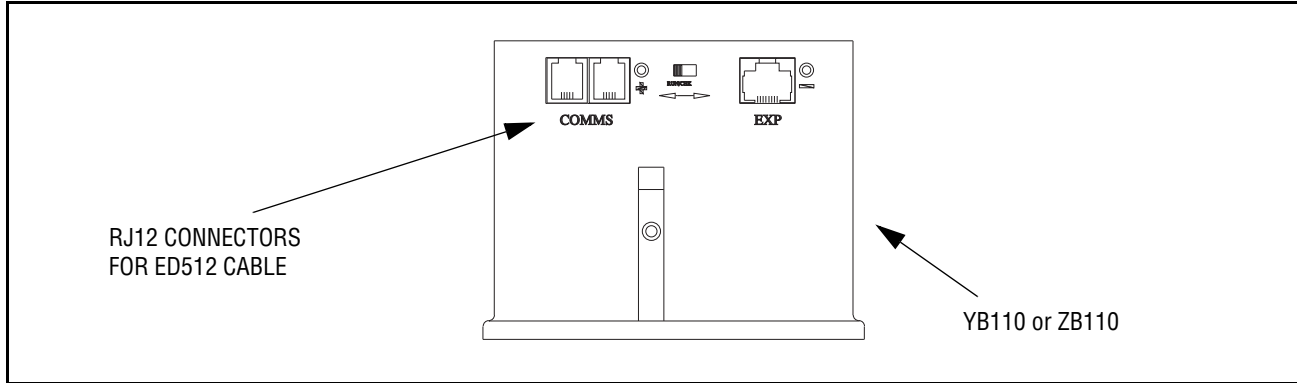
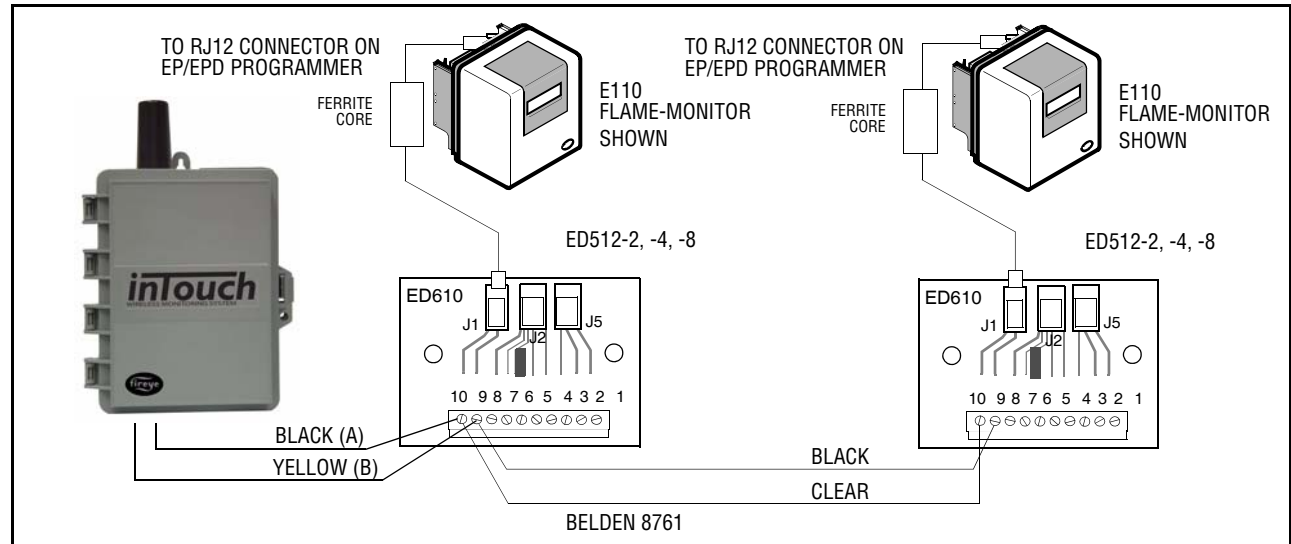

FIGURE 6. WIRING FOR MODBUS PROTOCOL



Alternate Hook-up Method

To connect the inTouch to a Flame-Monitor or BurnerLogix without the use of the ED610, connect the supplied cable from the inTouch to the ED512 directly or to a telephone handset type cable that is commercially available.

FIGURE 7.

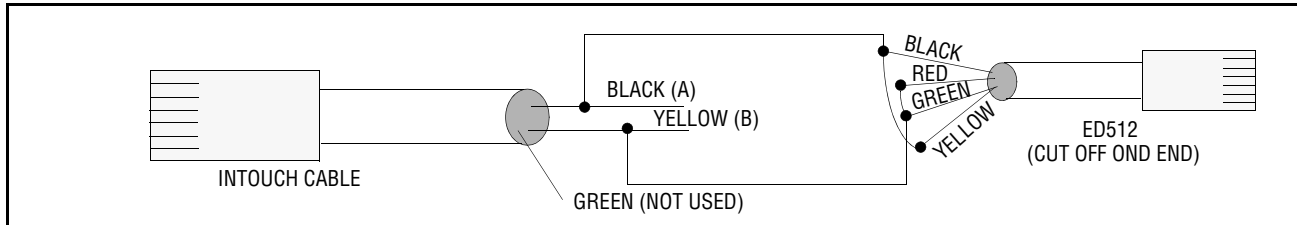

Verifying Communication

After all Fireye controls are properly connected and individually addressed, their connection to the inTouch device can be verified by depressing and releasing the OPTION button 3 times. The 7-seg-ment LED display will switch to a dash (—) symbol followed by the addresses of the devices it is successfully communicating. The display will then show the dash symbol followed by the signal strength power level it is receiving.

SNOOZE Feature

To allow for regularly scheduled testing of boiler/burner safeties such as flame failure, low water cut out, air flow checks, etc., without alarm messages being transmitted, the inTouch provides a SNOOZE feature. During the SNOOZE period the inTouch will not respond to any alarm or reset events.

The SNOOZE period lasts for 120 minutes and will automatically cancel if left uninterrupted. The SNOOZE feature can be cancelled at anytime after safety tests are satisfactorily performed.

To active the SNOOZE feature, press the SERVICE button. A service message will be dispatched and the display LED will change from its current signal strength reading to 'F'. The automatic 120 minute SNOOZE period will now begin.

To de-active the SNOOZE period and resume normal operation, do nothing and this function will cease after the 120 time out period or press the SERVICE button. The display LED will indicate the current signal strength reading.

Auxiliary Device Connection

The inTouch system provides for the connection of 4 dry contact and 4 AC inputs, see Fig. 1 . These can be used to transmit messages when a contact is detected as closed/open or power is applied/not applied to the AC inputs. The AC inputs accept voltages from 24 to 120 VAC at 3mA. Refer to dipswitch selection for dry contacts 3 & 4 and voltage inputs 7 & 8.

These can be used to connect to other equipment located in a boiler room such as other flame safeguard equipment that provide alarm output only. Dry contact devices used to detect empty fuel tanks, condensate spills or water on the floor can be connected and give instant alarm when unwanted events occur.

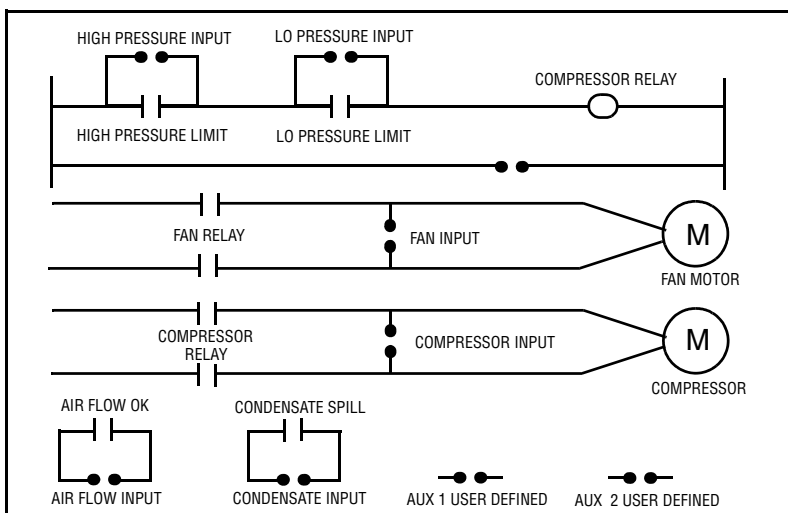

The messages transmitted can be configured to exactly what is causing the alarm condition. For example, the default message Input 1 Activated can easily be changed to transmit Air Flow Input Open. See the section on message configuration for more information.

CONFIGURING THE DEVICE MESSAGING

After you have received a Fireeye inTouch User ID and password, continue with the steps below to configure transmitter messages. If you have not, either contact the Fireeye inTouch *Account holder* to receive your User ID and password, or follow the steps in the next section to set up a Fireeye inTouch Account.

Access the Fireeye Web Page

- The Fireeye inTouch web page can be found at www.fireeye.com.
- Navigate your way to the inTouch section.
- Note that any time you want to return to the home page just click on the inTouch logo in the upper left.
-

Logging In

- Fill in the assigned *User ID* and *Password*. These are encrypted for security purposes.
- Click on Submit button.

FIGURE 8.



inTouch
WIRELESS MONITORING SYSTEM

InTouch Product Information & Monitoring Access

Logout Home Fireeye Products Promotions Sales Training Jobs Availability

Enter the assigned User ID and Password → Member Id:
Password:

Click on the Submit button → • Submit • Reset

User Information

- If this is the first time you are using this User ID, then you will automatically see the *Edit User Info* screen shown in Fig. 7. Otherwise, you can access this screen by clicking on the menu item *Edit user Info* or, if you know the *User Info* is correct, move on to the next step.
- The information on this screen refers to the address where the user can be contacted. Do not use this screen to input information on where the transmitter is located.
- All fields with check boxes are required.
- The four fields marked *Phone*, *Fax*, *E-mail*, and *Pager* will be the default locations where messages will be delivered. When setting up a particular unit, the values you input will automatically appear in the delivery fields (make sure required fields are entered). This makes configuring new units fast and easy. However, each message must be configured separately, and the locations where each message will be sent can be modified as required.
- Once you have completed the form, click on the *Submit* button.

FIGURE 9. USER INFO

- View & Edit Devices
- Install New Device
- Last Message Summary
- Manage All Deliveries
- User Information
- Credit References

The information on this form will be used for delivering your messages. You will receive email confirmation after submitting the form. Please provide the following contact information:

[Change your Password](#)

Password		
Company Name	<input type="text" value="FIREYE, Inc."/>	
First name	<input type="text" value="Michael"/>	
Last name	<input type="text" value="McCarron"/>	
Middle initial	<input type="text"/>	
Title	<input type="text" value="Single Burner Products Manager"/>	
Street address	<input type="text" value="3 Manchester Road"/>	
Address (cont.)	<input type="text"/>	
City	<input type="text" value="Derry"/>	
State/Province	<input type="text" value="NEW HAMPSHIRE"/>	
Zip/Postal code	<input type="text" value="03038"/>	
Time Zone	<input type="text" value="(GMT -05:00) Eastern Time (US & Canada)"/>	
Daylight Savings	<input checked="" type="checkbox"/> check if device location follows daylight savings	
Newsletter Subscribed	<input type="text" value="Yes"/>	

- Required field

THE ADDRESS PROVIDED SHOULD BE THE ADDRESS OF THE USER OF THIS DEVICE

The following information is used as default message delivery addresses. The fax number you enter is where faxed messages will be sent. The email address you enter is where email messages will be sent. You will have the option to change message delivery addresses when configuring an individual unit. Changing delivery address will affect future deliveries only.

THESE ARE THE DEFAULT LOCATIONS FOR MESSAGE DELIVERY

Fax	<input type="text"/>
E-mail (includes Alpha Pager, PCS)	<input type="text" value="jmjlmccar@mediaone.net"/>
Modem ("modem to modem" delivery)	<input type="text"/>
XML	<input type="text"/>
Numeric Pager(only)	<input type="text"/> Pin <input type="text"/>
Phone (for automated voice message delivery)	<input type="text"/>

- Submit
- Go Back

CLICK HERE WHEN YOU HAVE COMPLETED THE FORM

Device Summary

- When you have successfully logged in, you will be in the Device Summary screen (see Fig. 11).
- If you have any existing transmitters, they will appear in a list.
- To add your new device, click on the menu item *Install New Device* (see Fig. 8).

Input the Device ID number

- Before you can enter setup a new transmitter, you must know its ID number.
- The ID number for the transmitter is on a label on the radio and should be printed on the Monitored Equipment card which was provided with the unit.
- Enter the ID number and click the *Submit* button.

FIGURE 10. INSTALL NEW DEVICE



The purpose of this form is to verify that the Device ID you are entering is valid.



New Equipment Location

- The *New Equipment Location* form (see Fig. 9) refers to the equipment this transmitter is monitoring. If there are multiple pieces of equipment with transmitters in a single location, the information supplied should be sufficient to identify this particular piece of equipment from any others.
- All the information should be recorded on the MONITORED EQUIPMENT I.D. CARD provided.
- All the fields marked with check boxes are required.
- Do not use abbreviations such as **St** for Street or **Rd** for Road if you plan to use the voice message delivery.
- Do not use uppercase letters for words if you plan to use for voice message delivery (example - use “flow” not “FLOW”) as the synthesized voice will announce the individual letters not the word.
- The address fields should have the address where the transmitter is installed.
- The contact information should contain the name and phone number of the individual(s) who can provide access to the particular piece of equipment.
- The bottom four fields identify the equipment. It is important to get as much information about the equipment being monitored as possible. The information should be sufficient so a service person can get any appropriate parts for maintenance or repair before going to the equipment site.
- A sample e-mail message containing all the equipment information is shown on later in this section.

FIGURE 11. NEW EQUIPEMENT INFORMATION



The purpose of this form is to identify the location of the equipment being monitored and its type.

- Location Name: This field may be used to help identify a piece of equipment for example *Joe's Pizzeria* or *ABC Appliance RTU-3*
- Address information can be used for dispatch and equipment logs.
- Local Contact name and phone number are helpful if it is necessary to call ahead for a key or access.
- Enter Time Zone where equipment is located in order to properly time stamp messages.
- Equipment Information can be used to identify required replacement parts

Please provide the following device location information. This information will be used to identify where a piece of equipment is installed when a message is sent

CHOOSE FLAME-MONITOR, MircoM or BurnerLogix

BE AS SPECIFIC AS POSSIBLE

Device Id	1071	
Model number	Model FR-1	
Fireeye product, subunit 10	MicroM	<input type="checkbox"/>
Location Name		<input type="checkbox"/>
Street address		<input type="checkbox"/>
Address (cont.)		<input type="checkbox"/>
City		<input type="checkbox"/>
State/Province	State	<input type="checkbox"/>
Zip/Postal code		<input type="checkbox"/>
Local Contact Phone		<input type="checkbox"/>
Local Contact Person		<input type="checkbox"/>
Time Zone	Time zone	<input type="checkbox"/>
Daylight Savings	<input type="checkbox"/> check if device location follows daylight savings	

THIS IS THE ADDRESS OF THE EQUIPMENT THE TRANSMITTER IS MONITORING

- Required field

Please provide the following information about the equipment being monitored. This information will be helpful when replacement parts are needed for repair i.e. filters, belts, gas valve, ignition module.

Equipment Name	<input type="text"/>	} THIS INFORMATION SHOULD BE COMPLETE ENOUGH TO ALLOW A SERVICE PERSON TO GET THE APPROPRIATE PARTS BEFORE COMING TO THE EQUIPMENT SITE
Serial number	<input type="text"/>	



CLICK HERE WHEN THE FORM IS COMPLETE

Message Delivery

The default information entered in the *Edit User Info* (see Fig. 7) form will appear in the *New Device Delivery* form. You can use the default values or you can change them.

You can change where each type of message is sent and the message wording by clicking on *Message Delivery* on the menu bar and editing the information (see Fig. 13). To access *Message Delivery* menu, first click on *View and Edit Device* then click on *Location Name*. If you do not change them, then each message sent will be delivered to the *Phone*, *Fax*, *E-mail*, and/or the *Pager* specified in this form.

You **MUST** click on a check box on the right to enable a delivery method, and at least one **MUST** be checked.

The *Delivery Attempts* field indicates how many times Fireeye will attempt to deliver a message if the message is not successfully received. When the message is delivered successfully, no more attempts will be made.

If the message is not successfully delivered after the specified number of Delivery Attempts, an e-mail will be sent to the e-mail address of the Account holder (as set in the form *Open an Account* shown in Fig. 14). This will alert the Account holder that the User information may need to be changed or updated.

- The *Retry Interval* is the time period Fireeye will wait between attempts to deliver the message.

FIGURE 12. MESSAGE DELIVERY OPTIONS

View & Edit Devices | Install New Device | Last Message Summary | Manage All Deliveries | User Information | Credit References

Please check the box next to each delivery method you add. Changing a delivery address will not affect your user info.

Important: this screen allows you to add new delivery method for all messages on all your devices.

For help in setting these delivery methods, click on the name of the type or [here](#) for more information and examples.

Type	Address/number	Add
Phone	<input type="text"/>	<input type="checkbox"/>
Fax	<input type="text"/> Attn: <input type="text"/>	<input type="checkbox"/>
E-mail	<input type="text" value="jnjlmccar@mediaone.net"/>	<input type="checkbox"/>
Modem	<input type="text"/>	<input type="checkbox"/>
Pager	<input type="text"/> pin <input type="text"/>	<input type="checkbox"/>
E-mail/XML	<input type="text"/>	<input type="checkbox"/>

Are your delivery addresses often busy? How many delivery attempts do you want Notifact to make and at what interval?

Delivery Attempts Retry Interval 999999

- Required field

Annotations:

- Click on each type for detailed instructions (points to the Type column)
- Transmitter messages will be delivered via any of these modes when SET box is checked. (points to the Add checkboxes)
- Number of unsuccessful delivery attempts and the time between them (points to the Delivery Attempts field)
- Click here after you enter and checked off desired delivery methods (points to the Submit button)
- At least one method must be checked to enable (points to the Add checkboxes)

Transmitter is now included in the Device Summary

- You will now return to the Device Summary screen as shown below.
- The basic information on your transmitter will appear.

FIGURE 13.



These are devices already installed - select one to see more detail or modify settings. 'Copy' installs an additional device with the same location and message delivery details. 'Remove' removes the device and its messages.

'Replace' allows a new device to be swapped into this one's location.

****Remove, Copy and Replace Device functionality is available for device Owners only.****

Dev. ID	Location	Address	City	Remove Device	Copy Device	Replace Device
10 	Trane Commercial Controls / Atrium RTU-3	22 Voyager Parkway	White Bear Lake	Remove	Copy	Replace
144	Bayonne Housing / MEP235 KC1000	Rotary Drive	Bayonne	Remove	Copy	Replace
154	Hilton Hotel / KC-1000-6	650 Terrace Ave.	Hasbrouck Heights	Remove	Copy	Replace
157	Hilton Hotel / KC-1000	650 Terrace Ave.	Hasbrouck Heights	Remove	Copy	Replace
164	Mike's Underground / Boiler 1	18 Clancy St.	Chelmsford	Remove	Copy	Replace
1072 	Cleveland Demo / Burner 1	5258 Transportation Boulevard	Garfield Heights	Remove	Copy	Replace
1073	Cleveland Demo / MicroM	5258 Transportation Boulevard	Garfield Heights	Remove	Copy	Replace
1082 	Fireye Burner Lab / HB Smith	3 Manchester Rd	Derry	Remove	Copy	Replace

Click on this field to see the messages and detailed information for any transmitter

 - The appearance of this symbol next to the Device ID indicates the Device failed to report (heartbeat) in for more than 24 hours.

Device Information

- Clicking on the Location field (shown above) will bring up the Device Information screen (Fig. 12).
- A summary of the information which was entered in Fig. 8 (New Equipment Information) appears. If any of the information is not correct, click on the button Edit Device Location to make changes.
- Click on the menu item Message Delivery to edit message descriptions and to select where each type of message will be delivered.

FIGURE 14. DEVICE INFORMATION

View & Edit Devices	Install New Device	Last Message Summary	Manage All Deliveries	User Information	Credit References
Device Info	Message Delivery	Message History	Heartbeat History	Assign Users	
Location:	<i>Bayonne Housing, Rotary Drive, Bayonne, NJ, 05423</i>				
Equipment:	<i>Manufacturer:</i> <i>Model:</i> <i>Serial Number: Code 3</i> <i>Equipment Name: MEP235 KC1000</i>				
Contact:	<i>Name: Red Wagner</i> <i>Phone: (201)391-3456</i>				
Device ID:	144, subunit 1				
Device model:	FR-1				

Edit Device Location
Add Subunit

Last 3 messages

Message ID	Message Date	Message Description
6852	6/5/01 08:47:11	Lockout Ended
6762	6/5/01 07:48:36	Lockout Air Flow Open
6852	5/10/01 21:19:12	Lockout Ended

[more...](#)
CLICK HERE FOR LAST 90 LOCKOUTS OR HEARTBEATS
[more...](#)

Last Heartbeat

Date	Signal Strength	Pending Problem	Battery	Burner Address	System Hours	Burner Hours	Burner Cycles	Total Lockouts
7/10/01 02:11:34	4	No	OK	0	24	20	172	097

Equipment Usage

CLICK HERE FOR GRAPHICAL VIEW OF EQUIPMENT USAGE

Device Messages

- Clicking on the menu item *Message Delivery* will bring up the *Device Messages* screen as shown in Fig. 13.
- Each unit comes with predefined default messages. The description of the message can be changed for your specific application. Click on any field in the *Description* column to change it.
- Each specific message can be configured to be sent to various addresses using different delivery methods.
- To change an existing delivery address, click on any field in the *Delivery Address* column to change it. Note the only acceptable characters are A-Z, a-z and 0-9. Units of measurement, such as degrees or pounds should be spelled out and not abbreviated.
- To add a new delivery address for a message, click on the *Add* field.
- To remove a delivery method and address for a specific message, click on the *Delete* field.

FIGURE 15.

[View & Edit Devices](#)
 [Install New Device](#)
 [Last Message Summary](#)
 [Manage All Deliveries](#)
 [User Information](#)
 [Credit References](#)

[Device Info](#)
[Message Delivery](#)
[Message History](#)
[Heartbeat History](#)
[Assign Users](#)

This is a list of message deliveries for:

Device Id: *144, subunit 1*

Located at: *Bayonne Housing / MEP235 KC1000*

Description	Delivery Method	Delivery Address	Edit Delivery Method	Delete Delivery Method	Add Delivery Method
*Unit Failed to Report Heartbeat	E-MAIL	jmjmccar@mediaone.net	Edit	Delete	Add
Aux Link Trouble	E-MAIL	jmjmccar@mediaone.net	Edit	Delete	Add
Communication Loss	E-MAIL	jmjmccar@mediaone.net	Edit	Delete	Add
Communication Restored	E-MAIL	jmjmccar@mediaone.net	Edit	Delete	Add
Input 1 Activated	E-MAIL	jmjmccar@mediaone.net	Edit	Delete	Add
Input 2 Activated	E-MAIL	jmjmccar@mediaone.net	Edit	Delete	Add
Input 3 Activated	E-MAIL	jmjmccar@mediaone.net	Edit	Delete	Add
Input 4 Activated	E-MAIL	jmjmccar@mediaone.net	Edit	Delete	Add
Input 5 Activated	E-MAIL	jmjmccar@mediaone.net	Edit	Delete	Add
Input 6 Activated	E-MAIL	jmjmccar@mediaone.net	Edit	Delete	Add
Input 7 Activated	E-MAIL	jmjmccar@mediaone.net	Edit	Delete	Add
Input 8 Activated	E-MAIL	jmjmccar@mediaone.net	Edit	Delete	Add
Lockout Air Flow Closed	E-MAIL	jmjmccar@mediaone.net	Edit	Delete	Add
Lockout Air Flow Open	E-MAIL	jmjmccar@mediaone.net	Edit	Delete	Add

TO MAKE ANY CHANGES, CLICK ON EDIT, DELETE OR ADD





Check the Transmitter

- Check that the service button message will be sent to the appropriate address with the appropriate delivery method as described above.
- Have someone at the transmitter site press the *Service Button* (Fig. 1). If you do not have someone to press the *Service Button*, you can wait until the next morning and check the *Heartbeat*.
- The *Device Information* screen will show the message that the service button has been pressed.
- Also check that all the other appropriate messages were received. A sample e-mail message appears below. Make sure the appropriate individuals were paged, that the appropriate faxes were sent, and the appropriate phone calls were made.

From: Fireye
To: jmjlmccar@mediaone.net
Sent: Sunday, May 20, 2001 9:08 PM
Subject: May 20 2001 9:08PM (6852/40413)

Service Button on: Boiler 1 at: Calley's Crab Shack,
102 Waterfront Ave, Wilmington, DE.
Contact: Hearty Seaman at: (302)555-5555
(Make: Model:)
www.fireeye.com

Wireless Monitoring... Online

Check the messages

- Confirm the equipment information is correct including the name, model, make and address.
- Confirm the contact information is correct. The contact information should be the name and phone number of the individual(s) who can provide access to the equipment.



SETTING UP YOUR Fireeye inTouch ACCOUNT

To configure a transmitter, it is necessary to have an inTouch Account which will contain the billing information for the transmitter. If you have a User ID and Password, skip this section.

Access the inTouch Web Page

- The inTouch web page can be found at www.fireeye.com.
- A copy of the home screen is shown below.
- Note that any time you want to return to the home page just click on the inTouch logo in the upper left.
- Click on the menu item *Open an Account*.

New Account Setup

- The *New Account Setup* screen (see Fig. 14) allows you to set up your inTouch account.
- The information on this screen refers to the address where you will receive invoices for the inTouch service. Do not use this screen to input the information on where the User, or where the transmitter, will be located.
- Once you have filled in all the required fields, click on the *Submit* button.

Credit Application

The inTouch service may be billed monthly, quarterly, semi-annually or annually. Establishing a credit line will simplify this billing.

If you wish to establish a credit line now, fill out the *Credit Application* form and press the Submit button.













You may also print out the form and fax it to Fireeye at (603) 432-1570. If you prefer to do this, click on the button *Fill in Credit Application Later*.

Becoming an inTouch e-Partner

- You will receive a message thanking you for filling out the account information.
- Once your information has been verified, you will receive a User ID and password via e-mail.
- Be sure to record your inTouch User ID and password. For security purposes, you will not be able to check this information at the web site in the future.

FIGURE 16.

FIGURE 17.

Company Name	<input type="text"/>	
First Name	<input type="text"/>	
Middle initial	<input type="text"/>	
Last Name	<input type="text"/>	
Street Address	<input type="text"/>	
Address(cont)	<input type="text"/>	
City	<input type="text"/>	
State/Province	State <input type="text"/>	
Zip/Postal Code	<input type="text"/>	
Email	<input type="text"/>	
Phone	<input type="text"/>	
Fax	<input type="text"/>	
Pager	<input type="text"/>	
	Pin <input type="text"/>	
Modem	<input type="text"/>	
XML	<input type="text"/>	
Website Address	<input type="text"/>	
Type of Business	- <input type="text"/>	
Time Zone	Time zone <input type="text"/>	
Sales Rep.	Fireeye	
Daylight Savings	<input type="checkbox"/> check if device location follows daylight savings	
Password	<input type="password"/>	 up to 10 characters
Retype password	<input type="password"/>	
Do you want to fill credit references?	<input type="checkbox"/> check if you plan to install devices	

 - required field

Submit

Reset

CLICK HERE WHEN YOU
HAVE COMPLETED THE
FORM AND ARE READY TO
BECOME A MEMBER



SETTING UP MULTIPLE USERS

It is possible to set up multiple Users under a single Account. This advanced feature is available for Account Holders who may handle the billing of many transmitter units or who may require grouping Users by district or region. Each transmitter unit may have a separate User who will configure the unit based on their specific needs or requirements.

If your Account will require multiple Users, contact us at info@fireeye.com or by phone at (603) 432-4100. You will be issued a separate Account ID and password. This will enable you to add new Users and issue passwords to them.

ACCESSING YOUR inTouch ACCOUNT

After your inTouch device is installed and Flame-Monitor or MicroM controls are properly connected and verified, you can check the historical status of the equipment at any time. The Fireeye message center stores the last 90 lockouts and heartbeats for each piece of equipment connected. The data is current up to the last heartbeat received. You can also view the details of each lockout message, when it occurred and to whom it was delivered.

Through your internet provider connect to www.fireeye.com and navigate your way to the inTouch database. To access your account you will have to enter your User ID and password.



InTouch Product Information & Monitoring Access

[Logout](#) [Home](#) [Fireeye](#) [Products](#) [Promotions](#) [Sales](#) [Training](#) [Jobs](#) [Availability](#) [Tech Docs](#) [Y2K](#)

Member Id:
Password:

[• Submit](#) [• Reset](#)

After pressing the SUBMIT button a list of all installed devices registered under your account will be displayed.

View & Edit Devices

Install New Device

Last Message Summary

Manage All Deliveries

User Information

Credit References

These are devices already installed - select one to see more detail or modify settings. 'Copy' installs an additional device with the same location and message delivery details. 'Remove' removes the device and its messages. 'Replace' allows a new device to be swapped into this one's location.

****Remove, Copy and Replace Device functionality is available for device Owners only.****

Dev. ID	Location	Address	City	Remove Device	Copy Device	Replace Device
10 ★	Trane Commercial Controls / Atrium RTU-3	22 Voyager Parkway	White Bear Lake	Remove	Copy	Replace
144	Bayonne Housing / MEP235 KC1000	Rotary Drive	Bayonne	Remove	Copy	Replace
154	Hilton Hotel / KC-1000-6	650 Terrace Ave.	Hasbrouck Heights	Remove	Copy	Replace
157	Hilton Hotel / KC-1000	650 Terrace Ave.	Hasbrouck Heights	Remove	Copy	Replace
164	Mike's Underground / Boiler 1	18 Clancy St.	Chelmsford	Remove	Copy	Replace
1072 ★	Cleveland Demo / Burner 1	5258 Transportation Boulevard	Garfield Heights	Remove	Copy	Replace
1073	Cleveland Demo / MicroM	5258 Transportation Boulevard	Garfield Heights	Remove	Copy	Replace
1082	Fireeye Burner Lab / HB Smith	3 Manchester Rd	Derry	Remove	Copy	Replace

The information pertaining to that location along with the last 3 lockouts and the last heartbeat information for the selected device will now be displayed. Remember, every inTouch device can have multiple pieces of equipment connected and each piece of equipment must have its own Device ID. For example, in the figure above, Dev. ID 1082 and 1083 are actually the same inTouch device at the same physical location with two Flame-Monitors connected. Click on the location name of the device you want to get details about.

[View & Edit Devices](#)
[Install New Device](#)
[Last Message Summary](#)
[Manage All Deliveries](#)
[User Information](#)
[Credit References](#)

[Device Info](#)
[Message Delivery](#)
[Message History](#)
[Heartbeat History](#)
[Assign Users](#)

Location: *Bayonne Housing, Rotary Drive, Bayonne, NJ, 05423*
Equipment: *Manufacturer:
Model:
Serial Number: Code 3
Equipment Name: MEP235 KC1000*
Contact: *Name: Red Wagner
Phone: (201)391-3456*
Device ID: 144, subunit 1
Device model: FR-1



[Edit Device Location](#)

[Add Subunit](#)

Last 3 messages

Message ID	Message Date	Message Description
6852	6/5/01 08:47:11	Lockout Ended
6762	6/5/01 07:48:36	Lockout Air Flow Open
6852	5/10/01 21:19:12	Lockout Ended

[more...](#)

CLICK FOR DETAILED INFORMATION

CLICK FOR ADDITIONAL LOCKOUT HISTORY

Last Heartbeat

Date	Signal Strength	Pending Problem	Battery	Burner Address	System Hours	Burner Hours	Burner Cycles	Total Lockouts
7/10/01 02:11:34	4	No	OK	0	24	20	172	097

[more...](#)

CLICK FOR ADDITIONAL HEART-BEAT INFORMATION

Equipment Usage

From this screen you get detailed information about the lockout message delivery, a message history listing of all lockouts for the equipment, the heartbeat information for the last 90 days, and equipment usage statistics for the last month. Also from this page you are allowed to edit the device information, such as the contact person and phone number or description of equipment. For instance, when you click on the one of the last 3 lockout messages, a screen will appear displaying the time and date of the lockout and the person and method by which it was delivered.



[View & Edit Devices](#)
[Install New Device](#)
[Last Message Summary](#)
[Manage All Deliveries](#)
[User Information](#)
[Credit References](#)

[Device Info](#)
[Message Delivery](#)
[Message History](#)
[Heartbeat History](#)
[Assign Users](#)

For message: **Lockout Air Flow Open**
 Sent at: **6/5/01 06:48:36**

Delivery Method	ID	Result	Delivery Address	Delivery Time
E-MAIL	41386	DELIVERED	jmjmccar@mediaone.net	6/5/01 06:48:36

[Go Back](#)

You can view the up to the last 90 heartbeats by clicking on the more displayed below the last heartbeat received.

[View & Edit Devices](#)
[Install New Device](#)
[Last Message Summary](#)
[Manage All Deliveries](#)
[User Information](#)
[Credit References](#)

[Device Info](#)
[Message Delivery](#)
[Message History](#)
[Heartbeat History](#)
[Assign Users](#)

This is a list of heartbeats for the past 90 days for:

Device ID: *144, subunit 1*
 Located at: *Bayonne Housing / MEP235 KG1000*

Date	Signal Strength	Pending Problem	Battery	Burner Address *	System Hours *	Burner Hours *	Burner Cycles *	Total Lockouts *
7/10/01 02:11:34	4	No	OK	0	24	20	172	097
7/9/01 02:17:28	3	No	OK	0	24	19	157	097
7/8/01 02:23:26	2	No	OK	0	24	20	185	097
7/7/01 02:23:43	3	No	OK	0	24	19	165	097
7/6/01 02:29:21	3	No	OK	0	24	19	197	097
7/5/01 02:11:28	1	No	OK	0	24	18	213	097
7/4/01 02:35:16	4	No	OK	0	24	19	202	097
7/3/01 02:12:14	3	No	OK	0	24	19	167	097

Typically the inTouch device sends a heartbeat to the Fireeye message center during the least busiest cell time hours. These are times when cellular traffic is usually at the lowest and costs to transmit are also at the minimum. For the unit pictured above the heartbeats were established to transmit to the message server after 1:00 AM. However, due to signal levels below the minimum required, the inTouch system was not able to consistently report in at its regular time. When steady signal level was restored, the inTouch system re-synchronized itself and began reporting in during its previously established 1:00 AM period.

Just as you can display the last 90 days of heartbeat information, the Fireeye message server also stores the lockout history of the connected equipment. These can be viewed by clicking on the more displayed below the last 3 lockout messages displayed.

[View & Edit Devices](#) [Install New Device](#) [Last Message Summary](#) [Manage All Deliveries](#) [User Information](#) [Credit References](#)

[Device Info](#) [Message Delivery](#) [Message History](#) [Heartbeat History](#) [Assign Users](#)

This is the message history for:

Device ID: *144, subunit 1*
Located at: *Bayonne Housing / MEP235 KG1000*

Message Id	Message Date	Message Description
6852	6/5/01 08:47:11	Lockout Ended
6762	6/5/01 07:48:36	Lockout Air Flow Open
6852	5/10/01 21:19:12	Lockout Ended
6762	5/10/01 19:57:58	Lockout Air Flow Open
6852	5/3/01 10:59:36	Lockout Ended
6762	5/3/01 10:16:34	Lockout Air Flow Open
6850	5/3/01 03:44:01	Communication Restored
6853	4/23/01 22:31:45	Communication Loss

You can also click on any of the stored lockouts to get a view of the message delivery of that particular lockout.



NOTICE

When Fireeye products are combined with equipment manufactured by others and/or integrated into systems designed or manufactured by others, the Fireeye warranty, as stated in its General Terms and Conditions of Sale, pertains only to the Fireeye products and not to any other equipment or to the combined system or its overall performance.

WARRANTIES

FIREYE guarantees for *one year from the date of installation or 18 months from date of manufacture* of its products to replace, or, at its option, to repair any product or part thereof (except lamps, electronic tubes and photocells) which is found defective in material or workmanship or which otherwise fails to conform to the description of the product on the face of its sales order. **THE FOREGOING IS IN LIEU OF ALL OTHER WARRANTIES AND FIREYE MAKES NO WARRANTY OF MERCHANTABILITY OR ANY OTHER WARRANTY, EXPRESS OR IMPLIED.** Except as specifically stated in these general terms and conditions of sale, remedies with respect to any product or part number manufactured or sold by Fireeye shall be limited exclusively to the right to replacement or repair as above provided. In no event shall Fireeye be liable for consequential or special damages of any nature that may arise in connection with such product or part.



FIREYE®
3 Manchester Road
Derry, New Hampshire 03038 USA
www.fireeye.com

INT-1000
APRIL 16, 2013
Supersedes July 24, 2009