



BLZ-1001
JANUARY 30, 2014



ZB110/ZB230 FIREYE® BurnerLogix™

**MICROPROCESSOR-BASED
BURNER MANAGEMENT CONTROL
WITH INTEGRATED BOILER
CONTROL OPERATION**



DESCRIPTION

The Fireeye® BurnerLogix™ Z System expands on the standard BurnerLogix Y System (see bulletin BL-1001) by combining boiler control functions with the same burner management control found in the Y system. The result is a single compact package that can directly control the boiler's output firing rate based on either input pressure or temperature or both. The BurnerLogix Z System is designed to provide the proper burner sequencing, ignition and flame monitoring protection on automatically ignited oil, gas, and combination fuel burners. Through the display, the operator programs the desired setpoint, cut in, cut out and modulating range and with PID control, the BurnerLogix Z System controls the burner/boiler from start up through shutdown, precisely maintaining the desired setpoint. The BurnerLogix Z System continuously monitors interlocks and limits found in the L1-3 and 3-P circuits as it programs the burner/blower motor, ignition and fuel valves to provide for proper and safe burner operation. VFD and LCD displays are available that may be either plugged in or mounted remotely to give full language descriptors of current status and diagnostic lockout information as well as provide a user friendly menu system to make setting the boiler parameters easy and understandable. When mounted remotely, the displays provide NEMA 4x(IP66) protection. Through SMART LED'S, located on the front cover or through the display interface, the control provides current operating status and lockout information in the event of a safety shutdown. Following are some of the major control and monitor capabilities provided by the BurnerLogix Z System:

- **Operating Control Function** for automatic sequencing of the boiler system to start and stop the boiler to meet system demand.
- **Full Modulation Control** of fuel and combustion air through the firing rate motor to meet system demand.
- **Solid State Sensors** to monitor steam pressure, water temperature, stack temperature, boiler water temperature, or outdoor air temperature.
- **High Pressure and Temperature Alarm Limits** based on inputs from solid state sensors. Exceeded limits will open interlock circuit to the flame safeguard control for shutdown of the burner and boiler.
- **Cold Start Thermal Shock Protection** to slowly increase the burner firing rate on a cold start to limit mechanical stress due to thermal differences.
- **Multiple Lead/Lag** operation of two or more boilers.
- **User-friendly keypad display system** in either VFD or LCD format featuring the all-info display mode, program and review of system setpoints and operating parameters.
- **Remote Communication Capability** allows reading and writing of all setpoint information.
- **Password Protected Parameters** (two levels of security) to restrict unauthorized entry and modification of system setpoints and operating parameters.

- **Marginal High Pressure and Temperature Alarm Limits** based on input from solid state sensors to indicate system approaching high alarm limits.
- **Programmable Maximum High Fire Position** of modulating firing rate damper motor.
- **Assured low fire cut off** prevents unnecessary stress caused by burner shut down at high fire.
- **Auto / Manual firing rate** control with bumpless transfer

A complete BurnerLogix Z System includes the ZB110 (ZB230) chassis equipped with the type of flame amplifier required for the application, appropriate flame detector, plug-in programmer module, appropriate temperature/pressure transducer, wiring base and alpha-numeric display. Interchangeable YP1XX type programmer modules allow for complete versatility in selection of function, timing and flame failure response times. Refer to BurnerLogix PROGRAMMER SELECTION later in this document for the various combinations of programmer and display modules.



CAUTION: While programmers are mechanically interchangeable in that they mate with a common chassis/amplifier module, you should select the correct model for your application. Inappropriate application of a control could result in an unsafe condition hazardous to life and property. Selection of a control for a particular application should be made by a competent professional, such as a boiler/burner service technician licensed by a state or other government agency.

The ZB110 (ZB230) is a chassis/flame amplifier module complete with mounting screws and blank display module. The display module (BLV512 or BLL510), if required, must be ordered separately. Functions such as pre-purge time, recycling or non-recycling interlocks, high fire proving interlock, and trial for ignition timing of the pilot and main flame are determined by the programmer module. The BurnerLogix Z System can be used with ultra-violet, autocheck infrared, flame rod, self-check ultraviolet flame scanners or direct coupled by choosing the proper chassis/flame amplifier module.

Wiring bases for the BurnerLogix Z control are available pre-wired with 4 foot lead wires color coded and marked for easy installation or with an integral terminal block capable of accepting up to 2 X 14 AWG wires. The wiring base terminal block is available with knockouts for conduit or open ended for cabinet mounting. The pigtail wiring base is 4" X 5" and the terminal block wiring base is 4" X 7".

Additional functions of the BurnerLogix Z System include:

- A non-volatile memory which allows the control to remember its history and present position even when power is interrupted.
- A consistent flame signal read-out via display module or 4-20 mA output.
- Read-out of main fuel operational hours and complete cycles via display module.
- Modbus communications via RS485 multi-drop link.
- Proof of fuel valve closure during off cycle.
- Burn-in time of program parameters occurs after 8 hours of main valve on time.
- A run/check switch which allows the operator to stop the program sequence in any of four different positions (Purge, PTFI, MTFI or Auto).
- Remote Display mounting with NEMA 4X/IP66 protection.
- Remote Reset
- Programmable communication baud rate allows for DCS compatibility.
- Keypad selectable language readout.
- Revert to pilot can increase burner turn down.
- Additional terminals provided for applications requiring additional inputs and outputs.



WARNING: Electro-mechanical high steam pressure or high water temperature limits must remain in the running interlock circuit of the flame safeguard control.



TABLE OF CONTENTS

BURNERLOGIX SPECIFICATIONS	4
PART NUMBERS AND APPROVALS	7
ORDERING INFORMATION	8
INSTALLATION PROCEDURE	11
Wiring Base	11
Pressure And Temperature Sensor	13
BURNERLOGIX PROGRAMMER SELECTION	17
PTFI*MTFI Timings	18
LED INDICATOR LIGHTS	19
DESCRIPTION OF FUNCTIONS OF OPERATING CONTROLS	20
SETTING PROGRAMMER PARAMETERS	20
PROGRAM SET UP SUB-MENU	22
To View And Modify A Programmable Parameter	22
GETTING STARTED	24
General Information	24
All-info Screen	24
Set the Password	25
Units of Measure / Display Unit	26
System Test	27
Control Variable Configuration Sub-menu	27
SEQUENCE OF OPERATION - OPERATING CONTROL	29
SEQUENCE OF OPERATION - MODULATING CONTROL	30
SEQUENCE OF OPERATION - MARGINAL AND HIGH ALARM LIMITS	32
SEQUENCE OF OPERATION - LEAD/LAG CONTROL	34
ALTERNATE USES FOR LAG2 INPUT	36
SEQUENCE OF OPERATION - STANDBY WATER	37
Standby Lag Mode	38
Standby Thermal Shock Protection Mode	39
ALTERNATE USES FOR AUX 1 INPUT	40
ALTERNATE USES FOR AUX 2 INPUT	42
FLAME SCANNERS	44
Installation - UV Scanners	44
Operation - 45UV5 & 55UV5 Self-checking UV Scanner	45
Wiring - UV Scanners	46
Installation - Infrared Scanner Type 48PT	46
Operation - IR Learn	47
Installation - 69ND1 Flame Rod	49
SYSTEM INFO SUB-MENU	49
SYSTEM OPERATION	50
YP100 Operating Sequence	51
Start-up (Normal Cycle)	51
Normal Shutdown	53
Suggested Wiring Diagram for YP138 Programmer	54
LOCKOUT CODES	55
Safety Shutdown	55
Diagnostic Messages	56
Resetting the Control	56
Lockout Codes	57
Lockout History Sub-menu	58
COMMUNICATIONS	60
Message Format	60
Modbus Message Table	61
Interlock Annunciator	61
Boiler Operating Parameters	62
Inputs	64
Outputs	65
Explanation of Logstat	66
OPERATIONAL FEATURES	70
4-20 Ma Test Jacks	70
Check-run Switch	71
OPERATIONAL TEST	72
Test Checkout Procedures	72
Suggested Grounding Rules	74
BURNERLOGIX Z PROGRAMMING / SETUP GUIDE	77



BURNERLOGIX SPECIFICATIONS

Control:

Supply Voltage:

ZB110 120 VAC (+10%, -15%) 50/60 Hz

ZB230 230 VAC (+10%, -15%) 50/60 Hz

Power Consumption:

25 VA

Temperature Rating:

-40°C (-40°F) to +60°C (140°F)

Protection Category:

ZB110 (ZB230) control NEMA 1 (IP01)

Display, Remote mounted NEMA, 4X (IP66)

Unit Dimensions:

Wiring base 60-2850-1: - 4.0" (101 mm) W x 5.0" (127mm) H

Wiring Base 60-2852-1, 60-2854-1: - 4.0" (101 mm) W x 7.0" (178 mm) H

Shipping Weight:

ZB110 (ZB230) Approx. 3.2 lbs. (1.45kg)

Temperature Sensors:

Temperature Measurement Range:

TS350-X: 32°F to 350°F (0°C to 176°C)

TS752-X: 32°F to 752°F (0°C to 400°C)

RTD Type: Platinum, 100 ohms \pm 0.1% @32°F (0°C)

Temperature Coefficient: .00385 ohms/ohms/C

Output: 4-20 mA, linear with temperature

Operating Temperature Range: -13°F to 185°F (-25°C to 85°C)

Accuracy: \pm 0.75% of span

Thermowell Case: 300 Series stainless steel

Mechanical Fittings: 1/2-14 NPT

Pressure Sensors:

Pressure Measurement Range: 0 to 15, 0 to 30, 0 to 200, 0 to 300 psig

Excitation Voltage: 9-30Vdc (supplied by BurnerLogix control)

Accuracy: \pm 0.25% Full Scale (at constant temperature)

Output: 4-20 mA, linear with pressure

Maximum Over Pressure: 200% of full scale

Maximum Burst Pressure: 800% of full scale

Operating Temperature Range: -40°F to 185°F (-40°C to 85°C)

Fitting: 1/4" NPT Male

Electrical: 1/2" Conduit and Terminal Strip



OPERATING TEMPERATURE LIMITS

CONTROL	MAXIMUM		MINIMUM	
	°F	°C	°F	°C
ZB110/ ZB230	140°F	60°C	-40°F	-40°C
YP Programmers	140°F	60°C	-40°F	-40°C
BLV512, VFD Display	140°F	60°C	-40°F	-40°C
BLL510, LCD Display	140°F	60°C	-4°F	-20°C
Scanner UV1A, UV2, UV8A, UV90, 45UV3	200°F	93°C	-40°F	-40°C
45UV5-1005, 45UV5-1105 45UV5-1007, 45UV5-1009 55UV5-1007, 55UV5-1009	200°F	93°C	-40°F	-40°C
48PT2	140°F	60°C	-40°F	-40°C
Flame Rod (Tip 2460°F)	1500°F	816°C	-40°F	-40°C
TS350-X, TS7525-X Temperature Transducers	185°F	85°C	-13°F	-25°C
BLPS-15, 30, 200, 300 Pressure Transducers	185°F	85°C	-40°F	-40°C
Humidity: 90% R.H. (Non-condensing)				

LOAD RATINGS:

Terminal	Typical Load	A. Maximum Rating @120V-50/60 Hz	B. Maximum Rating @230V-50/60 Hz	C. Alternate Rating
M	Burner/Blower Motor	9.8 F.L.A. * 58 L.R.A.	4.0 F.L.A. * 20 L.R.A.	240 VA Pilot Duty (Motor Starter Coil)
10-11-12-X	Modulator	125 VA Pilot Duty		
A	Alarm	50 VA Pilot Duty		
Terminal ratings may be selected from either column A or C for 120 VAC or from either column B or C for 30 VAC: (select the rating from the column which best applies to the connected load on that terminal). * F.L.A. = full load amps; L.R.A = locked rotor amps				

Combination of fuel and igniter terminals

Combination No.	Pilot Fuel Trm 6	Main Trm 7	Ignition Trm 5	Delayed Valve Trm W
1	C	E	No Load	No Load
2	B	E	No Load	No Load
3	No Load	E	No Load	B
4	E	E	A	No Load
5	No Load	E	A	E
6	D	E	A	No Load
7	D	D	A	D
8	No Load	D	A	No Load

Composition of each combination

A	B	C	D	E
4.5A Ignition @120 VAC	50 VA Pilot Duty plus 4.5A ignition@ 120 VAC	180 VA Ignition plus motor valves with: 660 VA inrush, 360 VA open, 250 VA hold.	2A Pilot Duty @120 VAC	65 VA Pilot Duty plus Motor valves with: 3850 VA inrush, 700 VA open 250 VA hold.
2.2A Ignition @230 VAC	50 VA Pilot Duty plus 2.2A ignition @230 VAC		1A Pilot Duty @230 VAC	

Maximum connected load not to exceed 2000 VA



ELECTRICAL RATINGS

VA ratings (not specified as pilot duty) permit the connection of transformers and similar devices whose inrush current is approximately the same as their running current.

VA Pilot Duty ratings permit the connection of relays, solenoid valves, lamps, etc. whose total operating load does not exceed the published rating and whose total inrush current does not exceed 10 times the rating.

Running and locked rotor ratings are intended for motors. VA and VA Pilot Duty loads may be added to a motor load provided the total load does not exceed the published rating.



CAUTION: Published load ratings assume that no contact be required to handle inrush current more often than once in 15 seconds. The use of control switches, solenoid, relays, etc. which chatter will lead to premature failure. It is important to run through a test operation (with fuel shut off) following the tripping of a circuit breaker, a blown fuse, or any known instance of chattering of any external current consuming devices.

APPROVALS

Underwriters Laboratories Inc.:

MCCZ File MP1537
Controls, Primary Safety - Listed
MCCZ2 File MP1537
Controls, Primary Safety - Component
MCCZ7 File MP1537
Controls, Primary Safety Certified for Canada
MCCZ8 File MP1537
Controls, Primary Safety Certified for Canada - Component

Factory Mutual:

FM Class 7610

Acceptable by:

Industrial Risk Insurers (I.R.I.)

CE:

Gas Appliances
Gas Appliance Directive: 90/396/EEC
Low Voltage Directive: 73/23/EEC
EMC Directive: 89/336/EEC
GASTEC: 0063BT1754
(EN298, 2003; EN230, 2005)

DVGW

Reg. No. NG-2510BT0347

DIN-CERTCO:

Reg. No. 5F233/08



WARNING: This equipment generates and can radiate radio frequency energy, and if not installed and used in accordance with the instruction manual may cause interference to radio communications. It has been tested and found to comply with the limits for a Class A computing device pursuant to Subpart J of part 15 of FCC Rules, which are designed to provide reasonable protection against such interference when operated in a commercial environment. Operation of this equipment in a residential area is likely to cause interference in which case the user, at his own expense, will be required to take whatever measures which may be required to correct the interference.

PART NUMBERS AND APPROVALS

Table 1: Agency Approvals

BurnerLogix Chassis/Flame Amp. Module	 APPROVED	 US LISTED	 US			
ZB110UV	X	X	X	X	X	X
ZB110UVSC	X	X	X	X	X	X
ZB110IR	X	X	X	X	X	X
ZB110IR2	X	X	X	X	X	X
ZB230UV				X	X	X
ZB230UVSC				X	X	X
ZB230IR				X	X	X
ZB230IR2				X	X	X
BurnerLogix Programmer Module						
YP100	X	X	X			
YP102	X	X	X			
YP138	X	X	X			
YP118	X	X	X			
YP183	X	X	X			
YP113	X	X	X	X	X	X
YP115	X	X	X	X	X	X
BurnerLogix Displays						
BLV512	X	X	X	X	X	X
BLL510	X	X	X	X	X	X
BurnerLogix Wiring Bases						
60-2850-1	X	X		X	X	X
60-2852-1	X		X	X	X	X
60-2854-1	X		X	X	X	X

X = CERTIFICATION IN HAND

APPLICABLE BULLETINS

Programmers, Non-recycle Operation	YP-1001
Programmers, Recycle Operation	
Programmers, Non-modulating	
Displays	BD-5001
Wiring base installation, 60-2850-1	133-701
Wiring base installation, 60-2852-1	133-702
Wiring base installation, 60-2854-1	133-702
Pressure/Temperature Sensors	BLZPTS-1
Interlock Expansion Module	YZEM-3001



ORDERING INFORMATION

BurnerLogix Chassis/Flame Amplifier Module	
ZB110UV	120 VAC input with UV non self-check amplifier
ZB110UVSC	120 VAC input with UV self-check amplifier
ZB110IR	120 VAC input with IR auto-check amplifier
ZB110IR2	120 VAC input with IR auto-check amplifier (special application only - consult factory)
ZB230UV	230 VAC input with UV non self-check amplifier
ZB230UVSC	230 VAC input with UV self-check amplifier
ZB230IR	230 VAC input with IR auto-check amplifier

BurnerLogix Programmer Modules	
YP100	Keypad selectable parameters, non-recycle operation, modulation, open damper proving, 4 second FFRT
YP102	Keypad selectable parameters, non-recycle operation, modulation, open damper proving, 2 second FFRT
YP138	Keypad selectable parameters, non-recycle operation, modulation, open damper proving, indefinite pilot hold, revert to pilot from auto, 4 second FFRT
YP118	Keypad selectable parameters, non-recycle operation, modulation, open damper proving, indefinite pilot hold, revert to pilot from auto, 1 second FFRT
YP183	Same as YP138, terminal W used for purge complete, no voltage on 21 to move to pilot, no voltage on 16 to move to main.
YP113	Keypad selectable parameters, non-recycle operation, modulation, open damper proving, 1 second FFRT
YP115	Keypad selectable parameters, non-recycle operation, modulation, open damper proving, 1 second FFRT

BurnerLogix Displays	
BLV512	Display, 2 line X 16 characters, VFD, with cable, NEMA 4
BLL510	Display, 2 line X 16 characters, LCD, with cable, NEMA 4

BurnerLogix Wiring Bases	
60-2850-1	Pigtail wires, 4 foot long, 4"W x 5"H
60-2852-1	Closed base with terminal block and knockouts, 4"W x 7"H
60-2854-1	Open base with terminal block. 4"W x 7"H

BurnerLogix Accessories	
129-178-4	Kit, remote mounting, BurnerLogix display, 4 ft. cable, provides NEMA 4 protection
129-178-8	Kit, remote mounting, BurnerLogix display, 8 ft. cable, provides NEMA 4 protection
BLD500	Blank display module, included with ZB module
IT1000	Alarm annunciation system using wireless technology
61-5745-3	Shutter drive assembly for redundant self-check scanners



SCANNER SELECTION

FIREYE P/N	DESCRIPTION	USE WITH CHASSIS	BULLETIN
48PT2-1003 48PT2-9003 48PT2-1007 48PT2-9007 4-263-1	Infrared 1/2" straight mount 96" (2438mm) TC-ER cable Infrared 1/2" straight mount 96" (2438mm) TC-ER cable Infrared 1/2" straight mount 48" (1219mm) TC-ER cable Infrared 1/2" 90° angle mount 48" (1219mm) TC-ER cable Replacement photo detector	ZB110IR ZB230IR	SC-103
UV1A3 UV1A6 UV8A UV2 UV2A6 45UV3-1050 UV90-3 UV90-6 UV90-9	UV 1/2" straight 36" (915mm) TC-ER cable UV 1/2" straight 72" (1830mm) TC-ER cable UV 1/2" 90° head 72" (1830mm) no armor flex UV 3/8" straight 36"(915mm) TC-ER cable UV 3/8" straight 72" (1830mm) TC-ER cable UV 3/4" cast aluminum housing 96" (2438mm) unshielded leads UV 90° lateral view with 36" (915mm) flex conduit UV 90° lateral view with 72" (1830mm) flex conduit UV 90° lateral view with 108" (2745mm) flex conduit	ZB110UV ZB230UV	SC-102
45UV5-1007 45UV5-1009 4-314-1	Self-check UV 1" BSP threads, 102-264VAC Self-check UV 1" NPT threads, 102-264VAC Replacement UV tube	ZB110UVSC ZB230UVSC	SC-101
45UV5-1005 45UV5-1105	Self-check UV 1" NPT threads, 61-5745-3 required Self-check UV 1" BSP threads, 61-5745-3 required	ZB110UVSC ZB230UVSC	133-645
55UV5-1007 55UV5-1009	Self-check UV 1" BSP, 102-264VAC, suitable for hazardous locations. Self-check UV 1" NPT, 102-264VAC, suitable for hazardous locations.	ZB110UVSC ZB230UVSC	SC-106

PRESSURE/TEMPERATURE SENSORS

FIREYE P/N	DESCRIPTION	BULLETIN
TS350-2, -4, -8	Temperature sensor, Range 32°F to 350°F (0°C to 176°C), 4-20 mA output, linear with temperature. Insertion length is 2, 4, and 8 inches. Stainless steel thermowell included with ½"-14 NPT mounting.	BLZPTS-1
TS752-2, -4, -8	Temperature sensor, Range 32°F to 752°F (0°C to 400°C), 4-20 mA output, linear with temperature. Insertion length is 2, 4, and 8 inches. Stainless steel thermowell included with ½"-14 NPT mounting.	BLZPTS-1
BLPS-15	Pressure transducer, 0-15 psi (0-1030 mb), 4-20 mA output linear with pressure. ¼" NPT mounting. Screw terminals and conduit adapter.	BLZPTS-1
BLPS-30	Pressure transducer, 0-30 psi (0-2070 mb), 4-20 mA output linear with pressure. ¼" NPT mounting. Screw terminals and conduit adapter.	BLZPTS-1
BLPS-200	Pressure transducer, 0-200 psi (13.80 Bar), 4-20 mA output linear with pressure. ¼" NPT mounting. Screw terminals and conduit adapter.	BLZPTS-1
BLPS-300	Pressure transducer, 0-300 psi (20.7 Bar), 4-20 mA output linear with pressure. ¼" NPT mounting. Screw terminals and conduit adapter.	BLZPTS-1

CHASSIS/AMPLIFIER

120 VAC, 50/60 Hz
 ZB110UV
 ZB110UVSC
 ZB110IR

230 VAC, 50/60 Hz
 ZB230UV
 ZB230UVSC
 ZB230IR



FRONT VIEW
 (WITH OPTIONAL DISPLAY INSTALLED)



SIDE VIEW
 (WITH OPTIONAL PROGRAMMER AND DISPLAY INSTALLED)

PROGRAMMER MODULE

YP100
 YP102
 YP113
 YP138
 YP118



DISPLAY MODULE

BLV512 - VACUUM FLUORESCENT
 BLL510 - LIQUID CRYSTAL

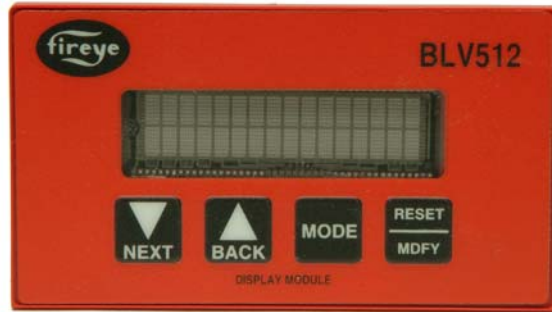

WIRING BASE

60-2854-1
 OPEN BOTTOM
 CABINET MOUNT

60-2852-1
 CLOSED BOTTOM
 CONDUIT KNOCKOUT



60-2854-1 SHOWN

WIRING BASE

60-2850-1
 PRE-WIRED
 4 FOOT
 COLOR CODED



INSTALLATION PROCEDURE

WIRING BASE

Install the wiring base where the relative humidity never reaches the saturation point. The BurnerLogix system is designed to operate in a maximum 90% relative humidity continuous, non-condensing environment. Do not install the BurnerLogix system where it can be subjected to vibration in excess of 0.5G continuous maximum vibration. The BurnerLogix system is not a weather tight enclosure. The standard vertical position is recommended. Allow at least one inch clearance around the control for service and installation.

1. Wiring must comply with all applicable codes, ordinances and regulations.
2. **Wiring must comply with NEC Class 1 (Line Voltage) wiring.**
3. Torque rating on terminal block screws is 4.4 in/lbs to 5.3 in/lbs.
4. Limits and interlocks must be rated to simultaneously carry and break current to the ignition transformer, pilot valve and main fuel valve(s).
5. Recommended wire routing of lead wires:
 - a. Do not run high voltage ignition transformer wires in the same conduit with any other wires.
 - b. Do not route flame detector lead wires in conduit with line voltage circuits. Use separate conduit where necessary.
6. Maximum wire lengths:
 - a. The maximum lead wire length is 200 ft. (61 meters) to terminal inputs (Operating limits, interlocks, valves, etc.).
 - b. Flame Detector lead wires: see section on flame scanners
 - c. Remote reset: The maximum length of wire is 500 feet (152 meters) to a normally open remote reset push-button, but should remain within sight and sound of the burner.
 - d. Modbus communications: The maximum cable length of wire is 3300 feet (1000 meters) for RS-485.

A good ground system should be provided to minimize the effects of AC quality problems. A properly designed ground system meeting all the safety requirements will ensure that any AC voltage quality problems, such as spikes, surges and impulses have a low impedance path to ground. A low impedance path to ground is required to ensure that large currents involved with any surge voltages will follow the desired path in preferences to alternative paths, where extensive damage may occur to equipment.

Select either the pre-wired wiring base (60-2850-1) or terminal block style (60-2852-1, 60-2854-1). Either wiring base type can be mounted on a din rail or directly mounted to the cabinet back plate. Refer to Figure 3 for mounting dimensions.

FIGURE 1.

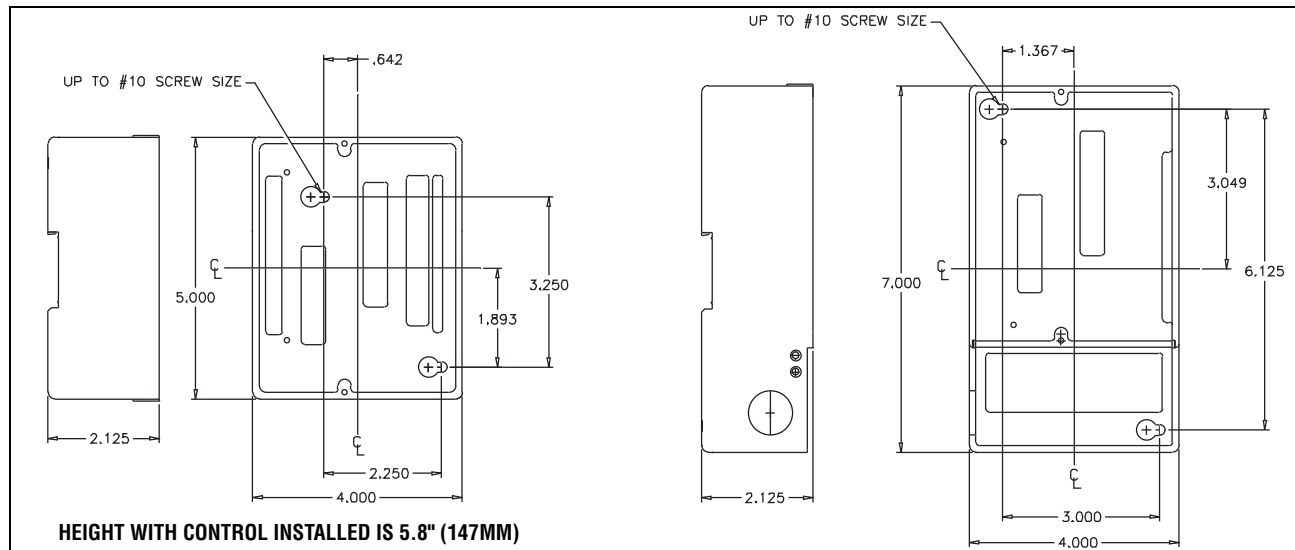



The location should be free from excessive vibration and within the ambient temperature rating.

FIGURE 2. WIRING BASE CONNECTIONS (shown for 120 VAC)

Terminal No. 60-2852-1 60-2854-1	Wire Color 60-2850-1	Type	Description	Rating
L1 (Hot)	Black		Line voltage supply	120 VAC (+10%, -15%), 50/60 Hz
L2 (Neutral)	White		Line voltage common	
EARTH	Green	Ground		
S1	Red/Wht		Scanner Input	300 VAC, 3 mA (UV models) 15 VDC (IR models)
S2	Blu/Wht		Scanner Input	300 VAC, 3 mA (UV models) 0 VDC (IR models)
A	Red	Output	Alarm	120 VAC, 1 A pilot duty
M	Brown	Output	Combustion Blower	120 VAC, 9.8 FLA, 58.8 LRA
3	Yellow	Input	Operating Control	120 VAC, 1 mA
13	Orange	Input	Fuel Valve End Switch, Pre-Ignition Interlock	120 VAC, 1 mA
P	Gray	Input	Running Interlock	120 VAC, 1 mA
D	Wht/Brn	Input	Low Fire Start Switch	120 VAC, 1 mA
8	Wht/Gry	Input	Open Damper Proving Switch	120 VAC, 1 mA
W	Wht/Orn	Output	Delayed Main Valve	See Load Ratings
5	LT Blue	Output	Ignition / Pilot Valve	See Load Ratings
6	Tan	Output	Pilot Valve	See Load Ratings
7	Violet	Output	Main Fuel Valve	See Load Ratings
16	DK Blue	Input	Lag 1 Input	See description for alternate uses
21	Pink	Input	Lag 2 Input	
LOW VOLTAGE INPUT/OUTPUT				
12	Wht/Yel	Output	Modulator Drive Positive	4-20mA Output
10	Wht/Red	Output	Modulator Drive Common	
X	Wht/Blue	Output	Temp/Pressure Source Voltage	28 vdc Nominal
11	Wht/Grn	Input	Temp/Pressure #1 (PCV)	4-20mA Input, Primary Control Variable
22	Wht/Vio	Input	Temp/Pressure #2 (AUX 1)	4-20mA Input
23	Brn/Wht	Input	Temp/Pressure #3(AUX 2)	4-20mA Input

UL does not apply to 230 VAC operations



PRESSURE AND TEMPERATURE SENSORS

1. Insure that the range of the selected pressure or temperature sensor is appropriate for the application. See Table 2

Table 2:

Part Number	Sensor Type	Set Point Range	Cut In	Cut Out	Mod Range	Increment Decrement
BLPS-15	0 - 15.0 psi	1.0 - 14.0psi	0 - 6.0psi	0.3 - 6.0psi	0.3 - 6.0psi	0.1 psi
	0 - 1030mb	70 - 960mb	0 - 410mb	20 - 410mb	20 - 410mb	10mb
BLPS-30	0 - 30.0 psi	1.0 - 28.0psi	0 - 6.0psi	0.3 - 6.0psi	0.3 - 6.0psi	0.1 psi
	0 - 2070mb	70 - 1930mb	0 - 410mb	20 - 410mb	20 - 410mb	10mb
BLPS-200	0 - 200 psi	10 - 190psi	0 - 60psi	3 - 60psi	3 - 60psi	1.0psi
	0 - 13.8b	0.7 - 13b	0 - 4.1b	0.2 - 4.1b	0.2 - 4.1b	.05b
BLPS-300	0 - 300 psi	10 - 280psi	0 - 60psi	3 - 60psi	3 - 60psi	1.0psi
	0 - 20.7b	0.7 - 19.3b	0 - 4.1b	0.2 - 4.10b	0.2 - 4.10b	.05b
Note: 1 psi = 68.9 mbar						
TS350-X*	32° - 350°F	36° - 338°F	0° - 60°F	3° - 60°F	3° - 60°F	1°F
	0° - 176°C	4° - 170°C	0° - 60°C	3° - 60°C	3° - 60°C	1°C
TS752-X*	32° - 752°F	36° - 725°F	0° - 60°F	3° - 60°F	3° - 60°F	1°F
	0° - 400°C	4° - 385°C	0° - 60°C	3° - 60°C	3° - 60°C	1°C
mb = millibar, p = psi, b = bar						

*Select Length X = -2", -4" or -8"

2. *Note: A general rule to follow when selecting the sensor range is that the expected value of the monitored pressure or sensor should fall between 40-70% of the upper range of the sensor. For example, a steam boiler maintains 20 lbs. pressure, select the BLPS-30 Pressure Sensor, with a 0-30 psig range.*
3. The sensors must be located where the ambient temperature will not exceed the maximum ambient operating temperature specified for the sensor.
4. Insure that the pressure range programmed on the BurnerLogix Z Control matches the installed pressure sensor.
5. Do not mount any of the sensors where they could be used as a footstep.

Installation must be performed by a trained, experienced flame safeguard technician.

MOUNTING PRESSURE SENSORS

Note: refer to Figure 3

1. The steam pressure sensors (BLPS-15, -30, -200, -300) provide a 1/4" NPT female fitting for connection to the steam header.
2. Make sure the boiler is shut down and zero steam pressure exists in the boiler vessel.
3. Disconnect power to the boiler controller so the boiler cannot sequence during installation of the steam pressure sensor.
4. Always mount the steam pressure sensor above the water line of the boiler.
5. Locate the pressure sensors where the ambient temperature will not exceed 185F
6. Use only a small amount of pipe compound to seal the connection joints. Excess pipe compound may clog the fitting and prevent proper operation of the sensor.

FIGURE 3.

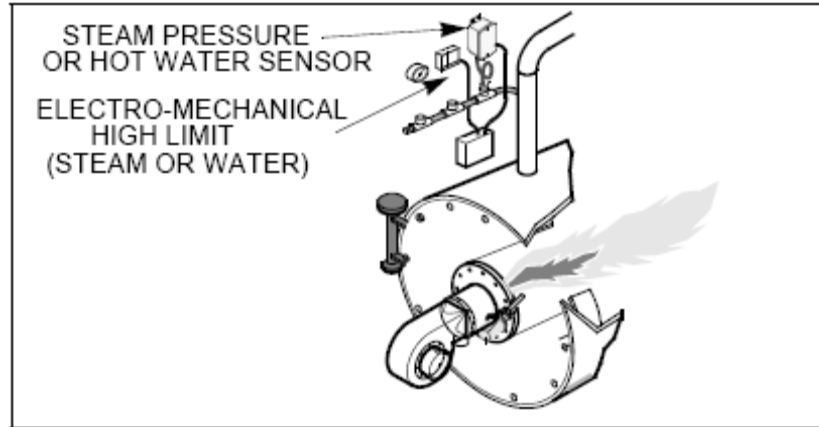

7. Although the unit can withstand substantial vibration without damage or significant output effects, it is good practice to mount the pressure sensor where there is minimum vibration.
8. A steam trap (siphon loop) must be connected between the boiler and the pressure sensor to prevent boiler scale and corrosive vapors from affecting the pressure sensor element.
9. Make all pipe connections in accordance with approved standards.
10. When tightening the sensor, apply a wrench to the hex flats located just above the pressure fitting. DO NOT tighten by using a pipe wrench on the housing. Do not tighten the pressure sensor by hand.



WARNING: The electro-mechanical high steam limit and/or high hot water temperature MUST REMAIN in the 3-P running interlock circuit.

MOUNTING TEMPERATURE SENSORS

The immersion style temperature sensors have a 1/2" NPT mounting for the 2", 4", and 8" thermowell probes, and a 1/2" conduit fitting for electrical connections.



WARNING: Location of the temperature sensor to monitor boiler water temperature of a steam boiler is critical. The sensor should be mounted where it is always exposed to the circulation of the boiler water, not too close to a hot or cold inlet or steam coil. Consult the boiler manufacturer for guidance on the sensor location

HOT WATER, STANDBY WATER TEMPERATURE

Note: Refer to Figure 3

1. Disconnect power to the boiler controller so the boiler cannot sequence during installation of the hot water temperature sensor.
2. The thermowell must be mounted where it is always exposed to the circulation of the hot water.
3. If the water system is full, drain the system below the point where the thermowell will be installed.
4. Tap an appropriate size fitting. (2", 4" and 8" thermowell have 1/2" NPT fitting).
5. Insert the appropriate thermowell (2", 4", or 8") and tighten.
6. Fill the system to check for leakage.

STACK TEMPERATURE

1. Use the existing well connection for the stack temperature sensor if provided by the boiler manufacturer.

2. If no well connection is provided, select an appropriate location for mounting the temperature sensor. Preferably as close to the boiler outlet as possible.

OUTDOOR TEMPERATURE

1. The outdoor air temperature sensor should be mounted on the outside of the building where it will be exposed to representative air temperature, but not to direct sunlight. A sun shield may be required.
2. Mount the temperature sensor high enough so it cannot be covered with snow, leaves, or other debris, or be tampered with. Vents from the building should be avoided

WIRING PRESSURE AND TEMPERATURE SENSORS



CAUTION: Disconnect power supply from the BurnerLogix Control before connecting wires to prevent electrical shock and equipment damage.

1. All wiring must be in accordance with National Electrical Code and local codes, ordinances, and regulations.
2. Sensor housing provides connection for 1/2" conduit.
3. The pressure and temperature sensors require 2 conductor, 18 gauge, shielded cable. Power limited, rated for 300V @105C. Use Belden 9318 or equivalent.
4. The shield should be connected to the earth ground terminal on the wiring base of the Burner-Logix Control (Terminal #E). The shield should be taped at the sensor to avoid unintended contact with the sensor housing.
5. All sensor wiring should be in a separate conduit. DO NOT install sensor wiring in any conduit or junction boxes with high voltage wiring.
6. Maximum wiring distance for sensor wiring is 100 feet.
7. See following chart for wiring terminations:

TS350/TS752	BLPS	PCV	AUX1	AUX2
1	+EXC	X (WHT/BLU)	X (WHT/BLU)	X (WHT/BLU)
2	-COM	11 (WHT/GRN)	22 WHT/VIO)	23 (BRN/WHT)



CAUTION: PROGRAM AND SET-UP

The proper operation of the BurnerLogix System and the pressure and temperature sensors require that the selected pressure ranges are appropriate for the application and must match the pressure range programmed on the BurnerLogix Control. Insure that the range of the selected sensor is correct for the application and pressure range matches the installed pressure sensor.

WIRING FIRING RATE MOTOR

1. All wiring must be in accordance with National Electrical Code and local codes, ordinances, and regulations.
2. For 4-20 mA motors, use 2 conductor, 18 gauge, shielded cable. Power limited, rated for 300V @105C. Use Belden 9318 or equivalent.
3. The shield should be connected to the earth ground terminal on the wiring base of the Burner-Logix Control (Terminal #E). The shield should be taped at the motor to avoid unintended contact with the motor housing.
4. All wiring should be in a separate conduit. DO NOT install wiring in any conduit or junction boxes with high voltage wiring.
5. Maximum wiring distance for sensor wiring is 100 feet.



WARNING: Controls require safety limits utilizing isolated mechanical contacts. Electronic limit switches may cause erratic operation and should be avoided.

BEFORE INSTALLING THE BURNERLOGIX CONTROL



CAUTION: Ensure that electric power is turned off. Refer to SN-100 for recommended grounding techniques.

Be aware that power to some interlocks (operating controls, air flow switches, modulating circuits, etc.) may be derived from sources other than what is controlling the BurnerLogix.

INSTALLING THE YP PROGRAMMER MODULE

The YP programmer module plugs into the side of the ZB110 (ZB230) chassis module and can only be installed in one direction. **DO NOT ATTEMPT TO FORCE THE YP PROGRAMMER INTO THE CHASSIS.** Referring to the illustration on the right, align the holes in the YP programmer housing with the posts located within the ZB chassis. Push the YP module into the chassis until the YP module is flush with the ZB housing.

If it is necessary to remove the YP programmer module from the ZB chassis, 2 slots are provided on the top and bottom of the YP housing. A small screwdriver can be used to ‘pop’ the programmer from the chassis.



Note: The BurnerLogix Z system can only be used with YP100, YP102, YP138, YP113 or YP118 programmers. All other programmer types will cause LOCKOUT, INVALID YP TYPE to be displayed.

For installations requiring CE certification:

After installation, the equipment should be protected from general access by means of a cabinet which is only accessible with a key or special tool and therefore a clear responsibility who replaced the fuse. If the fuse is blown during installation or operation, the control must be sent to the manufacturer to check.

ELECTRICAL CHECKOUT

If either a ground or a short circuit is detected, it must be eliminated before the control is plugged into the wiring base and power turned on.

Test the electrical field wiring for short circuits and grounds. The recommended method requires the use of an ohmmeter set on its lowest resistance scale.

6. Touch the meter probes together and calibrate accurately to ensure a reliable test.
7. Disconnect the neutral wire (L2) from the control system at the power source. Clip one meter test lead to the grounded green wire or to terminal E and with the other probe touch each other terminal. At no time should the meters show continuity or read 0 ohms.
8. Reconnect the neutral wire (L2) at the power source. Remove the test probe from the grounded terminal and reconnect it to Terminal L2 in the wiring base. With the other probe, touch each other terminal. It is normal to obtain a resistance reading on the meter at some terminals during this test as there are resistive loads (coils, transformers, lamps, etc.) connected whose normal DC resistance may be less than 5 ohms. However, at no time should the test meter read zero ohms.



CAUTION: Restore power for the following test.

9. With BurnerLogix installed, measure voltage from L2 to all other terminals. Reading should be zero on all terminals except L1.

INSTALL BURNERLOGIX INTO WIRING BASE

The BurnerLogix ZB chassis/amplifier module contains 2 screws permanently retained into the top and bottom of the housing. The wiring base contains two brass inserts with recessed threads to ease the installation. Line up the printed circuit board spacer located in the ZB chassis/amplifier module with the alignment tabs located in the wiring base. Firmly push the ZB model into the wiring base to assure the connectors mate properly. Tighten the screws into the brass inserts until snug.

REPLACEABLE FUSE

The following applies only to the ZB110 controls operating at 120 VAC, 50/60 Hz:

The chassis/amplifier modules are designed with a field replaceable fuse to protect Terminals 5, 6, 7 and W against short circuit loads or mis-wiring. In the event the fuse becomes OPEN, the display will indicate CHECK FUSE or the CLOSE DAMPER, AUTO and IGN LED's will light. An OPEN or blown fuse is a result of an over current condition on Terminals 5, 6, 7, or W. The over current condition causing the fuse to OPEN must be resolved before another attempt to apply power.

For installations requiring CE certification:

Only Fireeye or a Fireeye trained technician is allowed to replace the fuse.

All other installations:

The fuse is located on the printed circuit board containing the relays. To replace the fuse, remove power from the system and remove the control from its wiring base. Using an appropriate tool, remove the defective fuse and discard. Install a Fireeye replacement fuse (P/N 23-197). Re-install the BurnerLogix control in accordance with the installation procedure detailed in a previous section.

The ZB230 control contains a non-replaceable fuse and must be returned to the manufacturer for repair or replacement.

BURNERLOGIX PROGRAMMER SELECTION

All programmers for the BurnerLogix Series are designated with the prefix "YP". The functional operation, flame failure response time, purge timings, firing rate motor circuit, trial for ignition timings, recycling function and display messages are determined by the programmer.

A chart of the most common programmers is found below.

Take note of the programming sequence chart for each programming module for the proper explanation of prepurge timings.



WARNING: THE INAPPROPRIATE SELECTION OR APPLICATION OF A PROGRAMMER MODULE COULD RESULT IN AN UNSAFE CONDITION HAZARDOUS TO LIFE AND PROPERTY. The various programmer modules are interchangeable because they plug into a common ZB chassis. Many parameters are configurable through the keypad display. Care should be taken to insure the proper parameters are set. Refer to the appropriate programmer bulletin for appropriate settings. Selection of the programmer module and setting the various parameters for a particular application should be made by a competent professional, such as a Boiler/Burner technician licensed by a state or government agency, engineering personnel of the burner, boiler or furnace manufacturer (OEM) or in the performance of duties based on the information from the OEM.

WARNING: FOR IR MODELS, PRIOR TO VERSION 12, IT IS HIGHLY RECOMMENDED THAT AN "IR LEARN" OPERATION BE PERFORMED TO GUARANTEE RELIABLE OPERATION. REFER TO IR LEARN SECTION FOR MORE INFORMATION.



FIREYE PART NUMBER	Pre-purge Programming (Seconds)	Proven High Fire Interlock (M-8)	Proven Low Fire Interlock (M-D)	Terminal 6, Interrupted or Intermittent	Early Spark Termination	PTFI (5/6)	MTFI (5/6)	Running Interlock (3-P)	Flame Fail Time (Seconds)	Firing Rate Motor
SETTINGS SHOWN ARE FACTORY DEFAULT										
YP100	30	YES	YES	INTRP	NO	10/10	10/15	Non-recycle	4	YES
YP102	30	YES	YES	INTRP	NO	10/10	10/15	Non-recycle	2	YES
YP138	30	YES	YES	INTRP	NO	10/10	10/15	Non-recycle	4	YES
YP118	30	YES	YES	INTRP	NO	10/10	10/15	Non-recycle	1	YES
YP183	30	YES	YES	INTRP	NO	10/10	10/15	Non-recycle	4	YES
YP113	30	YES	YES	INTRP	NO	5/5	3/5	Non-recycle	1	YES
YP115	30	YES	YES	INTRP	NO	5/5	3/5	Non-recycle	1	YES

PTFI*MTFI TIMINGS

The BurnerLogix system provides keypad selectable timings for both PTFI and MTFI. The selections offered can provide 5 or 10 second timing for terminal 5 and 6 or a shortened time for terminal 5, allowing for early spark termination. BurnerLogix also provides selectable interrupted or intermittent operation for terminal 6.

The selections provided for PTFI*MTFI timings are:







Table 3:

SELECTION	PTFI		MTFI		COMMENT
	Term 5	Term 6	Term 5	Term 6	
10/10*10/15	10	10	10	15	
5/5*0/10	5	5	0	10	NO SPARK DURING MTFI
5/5*0/5	5	5	0	5	NO SPARK DURING MTFI
5/5*10/15	5	5	10	15	SHORTENED PTFI
5/5*10/10	5	5	10	10	SHORTENED PTFI
5/10*0/15	5	10	0	15	EARLY SPARK TERMINATION
5/10*0/10	5	10	0	10	EARLY SPARK TERMINATION
10/10*0/10	10	10	0	10	NO SPARK DURING MTFI
10/10*0/5	10	10	0	5	NO SPARK DURING MTFI
10/10*10/10	10	10	10	10	

LED INDICATOR LIGHTS

The BurnerLogix ZB control module has seven (7) LED indicator lights to annunciate the operating status of the control, as well as provide the reason for the last lockout condition. The “Open Damper” and “Close Damper” LED's provide easy set-up of the modulating motor end switches. Each LED has a graphic symbol to describe its function (see Table 4).

Table 4:

	FAN	Lights when the blower motor is energized (terminal M) and flashes when the RUN/CHECK switch is in the “CHECK” position during Purge, PTFI, MTFI and AUTO.
	OPEN DAMPER	Will blink when the modulator motor is being driven to the high fire position. (circuit 10-X made). Once the high purge switch closes (M-8), this LED will light constant. This LED provides the status of the high fire purge interlock circuit (M-8). This LED lights anytime the M-8 circuit closes during Pre-purge, PTFI, MTFI, Post Purge.
	CLOSE DAMPER	Will blink when the modulator motor is being driven to the low fire position (circuit 10-12 made). Once the low fire switch closes (M-D), this LED will light constant. This LED provides the status of the low fire start interlock circuit (M-D). This LED lights anytime the M-D circuit closes during Pre-purge, PTFI, MTFI, post purge.
	AUTO	Will light when the control releases to automatic modulating control (circuit 10-11 made).
	IGNITION	Will blink during Pilot Trial For Ignition (PTFI). Will light constant during Main Trial For Ignition (MTFI).
	FLAME	Will light whenever flame is detected by the flame scanner.
	ALARM	In the event of a lockout condition, the Alarm LED will blink, the remaining LED's will light up to indicate the lockout condition. See “Safety Lockout Codes.”



DESCRIPTION OF FUNCTIONS OF OPERATING CONTROLS

1. **Operating Controls:** Generally pressure or temperature activated, the operating control closes, causing the burner start-up sequence to begin. When the operating control opens, the burner shuts off. The operating control is connected in the L1-3 circuit on the wiring base.
2. **Limit Switches:** These are generally pressure, water level or temperature activated
 - a. Recycle — when it is desired to stop the burner when the limit switch opens and restart it when the limit switch recloses, they are connected between Terminals L1 and 3.
 - b. Non-Recycle —when it is necessary to stop the burner when the limit switch opens and prevent it from starting until both the limit switch recloses and the manual reset is activated, they are connected between terminals 3 and P.
3. **Fuel Valve End Switch Interlock:** This is generally an integral switch mounted on the main fuel valve and activated by the valve stem. It is connected between Terminal L1 & 13. The fuel valve end switch interlock prevents a burner start-up if the valve stem is not in the “valve closed” position. This interlock must remain closed while in STANDBY and until the start of PTFI.
4. **Purge Interlock:** Generally a firing rate motor linkage position switch or a differential air-pressure switch, that proves a maximum purge air flow rate. It is connected between Terminals M and 8. The purge interlock proves that the air damper is fully open and purge air flow rate is at maximum during the purge.
5. **Running Interlocks:** These generally are air flow switches, high and low fuel pressure switches, oil temperature switches, atomizing media pressure switches, and excess smoke density controls. These interlocks prove proper conditions for normal operation of the burner. They are wired in series and connected between Terminals 3 and P.
6. **Low Fire Start Interlock:** Generally a firing rate motor linkage position switch or a damper position switch, will prove both the linkage and dampers are in their proper positions to begin burner light off. This switch is connected between Terminals M and D.

SETTING PROGRAMMER PARAMETERS

In order to change the factory default parameters stored in the programmer module an optional keypad/display (BLV512 or BLL510) is required. All configurable parameters are stored within the PROGRAM SETUP sub-menu. The keypad/display module provides tactile feedback keys that are used to access the sub-menus inherent in the BurnerLogix system.

All programmed safety times and interlock configuration settings become permanent after 8 hours of main burner (Terminal 7) on time. (This does not apply to Boiler Parns).

The BurnerLogix display consists of 2 lines having 16 characters per line. The default displayed item is the current operating status. This would include the current point in the burner sequence followed by the parameter pertaining to that point in the sequence, such as time or the flame signal level. The bottom line is used to display the current operating status. The BurnerLogix display also provides the historical information stored in the control’s memory such as burner hours, cycles, lockouts and system hours. The remainder of the display items are menus with sub-menus indicated by a right facing arrow. The sub-menus indicate the current value of the selected item and in some cases can be modified to suit the application.

**STANDBY
PROGRAM SETUP >**

Keypad Description



The NEXT key is used to scroll down through the various menus and is also used to increment the value when in the modify mode. The BACK key is used to scroll up through the menus and is also used to decrement the value when in the modify mode. The MODE key is used to enter a sub-menu when the displayed item indicates a sub-menu with a right facing arrow and also to exit the sub-menu and move on to the next main menu item. The RESET/MDFY key is used to reset the BurnerLogix from a lockout condition, force a recycle of the programmer, indicate to the system the value displayed is to be modified or when done with the modification

used to reset the BurnerLogix from a lockout condition, force a recycle of the programmer, indicate to the system the value displayed is to be modified or when done with the modification

FIGURE 4. BURNERLOGIX MAIN MENU STRUCTURE

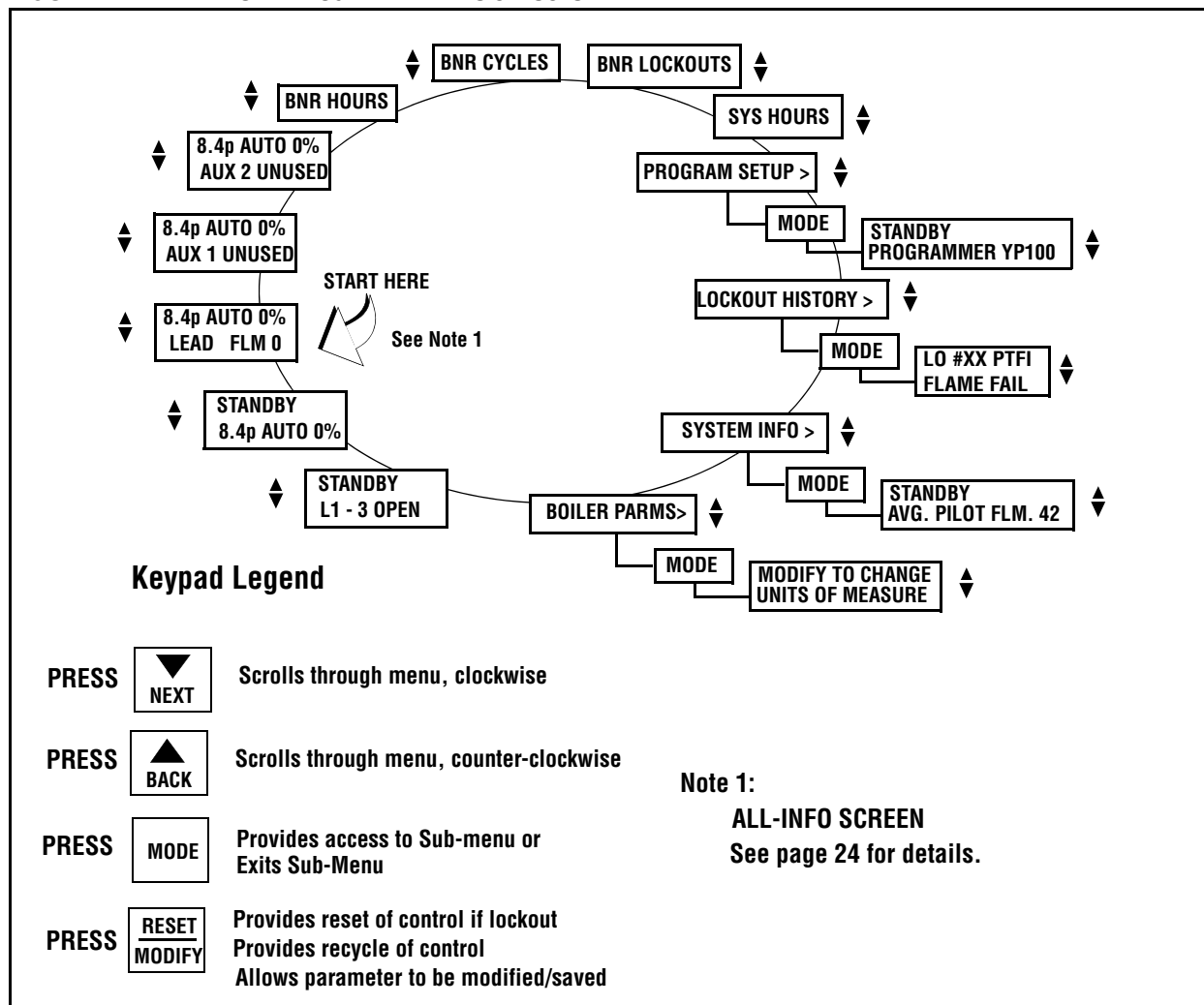

The BurnerLogix display system is made up of a number of circular menus and within these menus are sub-menus and in some cases further sub-menus within sub-menus. For example, within the BOILER PARMS sub-menu are additional sub-menus needed to set the various parameters for proper boiler operation, see Figure 7. The menus are circular in that continued pressing of the NEXT or BACK keys will eventually land you in the same place that you started. Any menu item that is followed by the '>' symbol indicates this is a sub-menu and pressing the MODE key will cause entry into the sub-menu. Pressing the MODE key from anywhere within a sub-menu will cause exit from the sub-menu and the next item from the previous menu will be displayed.

PROGRAM SET UP SUB-MENU

The sub-menu "PROGRAM SETUP" allows the user to review the various operational settings of the programmer module (e.g. programmer type, purge timing, etc.) and some instances modify the operational parameters to suit the application requirement. The MODE key is used to enter and exit the sub-menu and the NEXT and BACK keys are used to scroll through the menu as well as change the operational parameter.

FIGURE 5.

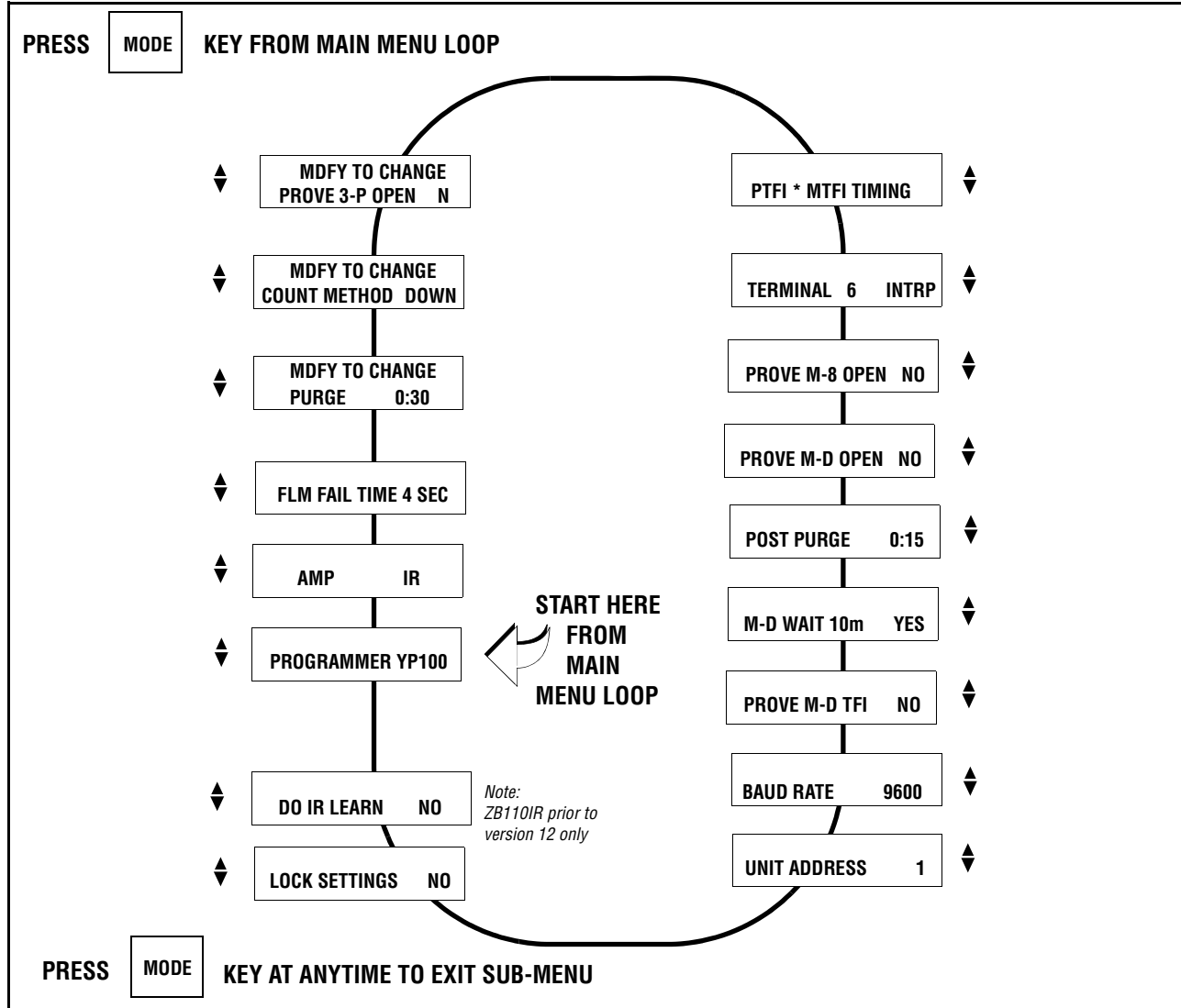

TO VIEW AND MODIFY A PROGRAMMABLE PARAMETER:

Use the NEXT or BACK key to scroll to PROGRAM SETUP see Figure 4. Press the MODE key to enter the sub-menu showing all program setup parameters. Pressing the MODE key while in the sub-menu will exit the sub-menu, and the next main menu item will be displayed. While in the sub-menu, pressing the NEXT key will scroll forward through the sub-menu. Pressing the BACK key will scroll backward through the sub-menu. When a modifiable parameter is displayed, the top line will indicate MDfy TO CHANGE while the bottom line will indicate the current item and its current value. Pressing the RESET/MDFY key will allow the displayed parameter to be modified. The item to be modified will move to the top line while its value will remain on the bottom line. At an infrequent rate, the top line will indicate MDfy TO SAVE. Use the NEXT or BACK keys to select the value to suit the application and when done, press the RESET/MDFY to save the value to memory.

Modifiable parameters located in PROGRAM SETUP MENU

Parameter	Factory Default	Range	Description
Purge time	00:30s	0:30s – 60:00m, 15 second increments. 0:10s-60:00m, YP113 0:00s-60:00m, YP115 (0:00s - 60:00m in YP3XX)	Applies to open damper purge time in YP1XX and YP2XX programmers and to low fire start time in YP3XX programmers.
Count method	DOWN	UP, DOWN	Time counts UP to final value or DOWN to zero from starting value. This setting will apply to all timer values.
Prove 3-P open at start	NO	YES, NO	Prevents jumped terminals. Requires the 3-P circuit to be open at the start of a cycle.
PTFI*MTFI timing	10/10*10/15 YP113 = 5/5*3/5	See chart page 18	Applies to terminals 5 and 6 operation during PTFI and MTFI.
Terminal 6 interrupted or intermittent	INTRP	INTRP, INTMT	Provide interrupted or intermittent operation on terminal 6.
Prove M-8 open	NO	YES, NO	If YES, M-8 must be open at start of open damper purge period. (YP1XX Series only).
Prove M-D open	NO	YES, NO	If YES, M-D must be open at end of open damper purge period. Does not apply to YP3XX Series.
Post purge	0:15	0:15s - 1:00m, 5 second increments.	Selects Post Purge time.
M-D WAIT 10m	YES	YES, NO	Select YES for lockout on M-D open for 10 minutes. Select NO for indefinite wait for M-D to close. This wait time applies prior to pilot trial for ignition.
PROVE M-D TFI	NO	YES, NO	Select YES to force lockout on M-D opening during PTFI and MTFI.
Baud rate	9600	4800, 9600, 19200, 38400	Sets communication baud rate
Unit address	00	00-31	Multi-drop requires unique addressing. Lowest address allowed for modbus is 01
Lock Settings	NO	YES, NO	Parameters can be stored to memory before automatic 8 hour store.
DO IR LEARN	NO	YES, NO	Select YES to activate IR LEARN process. See IR operation.

Shaded parameters not affected by 8 hour burn-in or LOCK SETTINGS.



All programmed settings become permanent if the BurnerLogix system has been powered continuously and 8 hours of main burner (terminal 7) on time has been accumulated. If the AC power is removed prior to accumulating 8 hours of main burner on time, the system burn-in time clock will be reset to zero. It is not necessary for the main burner on time to be continuous. The BurnerLogix accumulates burner on time in seconds. If necessary, the programmed settings can be made to become permanent anytime before the required 8 hours of main burner on time through the use of the optional keypad and the LOCK SETTINGS option under the PROGRAM SETUP sub menu.

Refer to SYSTEM INFO Sub Menu, page 49, for language selection.

GETTING STARTED

The BurnerLogix Z System performs two main functions, burner management and boiler control. For burner management, the BurnerLogix Z System continuously monitors interlocks and limits found in the L1-13, L1-3 and 3-P circuits as it programs the burner/blower motor, ignition and fuel valves to provide for proper and safe burner operation. For boiler control, the BurnerLogix Z system continuously reads the input pressure or temperature transducer, compares the reading to the appropriate user programmable setpoint, and adjusts the firing rate to meet output demand.

GENERAL INFORMATION

Once the sensor usage and range is selected and programmed, the user then programs the setpoints associated with the operating control function of the BurnerLogix Z System. These setpoints are Steam Pressure Setpoint (STM STPT) or Water Temperature Setpoint (WTR STPT), Cut In (CUT IN), and Cut Out (CUT OUT) and Modulating Range (MOD RNG).

1. CUT IN Setpoint is a differential value that is subtracted from the Setpoint to determine where burner startup occurs.
2. CUT OUT Setpoint is a differential value that is added to the Setpoint to determine where burner shutdown occurs.
3. MOD RNG Setpoint is a differential value that is subtracted from the Setpoint and determines the range over which the firing motor will travel from high fire (100%) to low fire (0%). See Figure 5.

STANDBY L1-3 CLOSED

This is an indication the mechanical limits (burner on switch, first low water cutoff, etc.) located in the L1-3 operating control (recycling) circuit are closed but the burner is in a shutdown or standby state due to the current measured primary control variable reading, pressure or temperature, is above the cut in point.

ALL-INFO SCREEN

The BurnerLogix Z control provides all boiler control information as part of one display screen located in the main BurnerLogix menu structure. From any burner operating position, the user can see the current operating temperature or pressure, mod motor usage and firing range position, operating mode and flame signal detected.

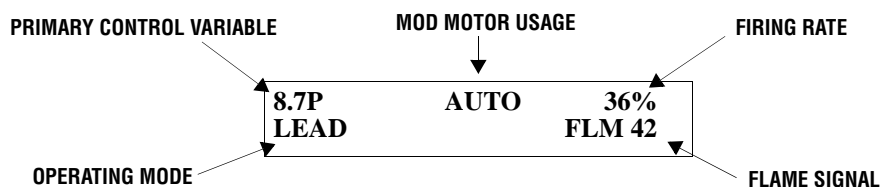

While in STANDBY or AUTO mode the ALL-INFO screen becomes the default screen, occurring 10 seconds after that state is reached.

Programming/Set-up Guide

Included with this bulletin is a Programming/Set-up guide see page 77 and page 78 to aid the user in programming the control. The set-up sheet lists all of the setpoints associated with the BurnerLogix Z control. The set-up sheet is a valuable tool by providing an overview of what setpoints need to be programmed for the various functions, as well as providing a written copy of the setpoints to refer to when actually programming the setpoints. It also serves as a permanent hard copy record.

The BurnerLogix Z requires the user to program a number of operating parameters for proper system operation. While the BurnerLogix Z Control offers a number of features and functions, a user can

program four basic steps to get the boiler up and operational, while becoming familiar with the operation and programming of the control. These four steps are:

1. Enter the 2 level password.
 2. Select and program the appropriate sensor ranges.
- Note: A general rule to follow when selecting the appropriate range for the sensor is the expected value of the monitored pressure or temperature should fall between 40-70% of upper range of the sensor. For example, a steam boiler maintains 20 pounds pressure, select the BLPS-30 Pressure Sensor with a 0-30 PSIG range.*
3. Program the desired operating control function (setpoint, cut in, and cut out).
 4. Program the modulating control function (mod range, mod max, mod use).

If necessary or desired, program cold start protection (thermal shock).

FIGURE 6.

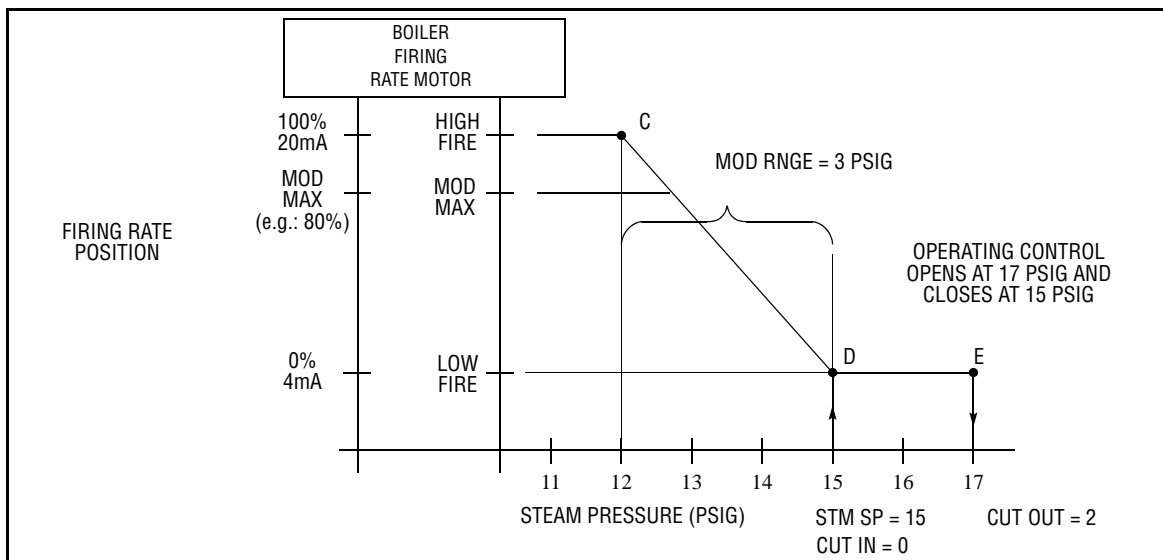

SET THE PASSWORD

The BOILER PARMS sub-menu contains the parameters that controls the operation of the burner while the burner is in either standby or main firing. To prevent unauthorized entry and modification of system setpoints and operating parameters, these parameters are password protected

IMPORTANT: THE BURNERLOGIX Z SYSTEM IS SHIPPED WITH THE SOFTWARE PASSWORD SET BY THE FACTORY. THE USER CANNOT PROGRAM ANY SETPOINTS UNTIL THE PASSWORD IS ENTERED. FACTORY DEFAULT PASSWORDS ARE:

LEVEL 1 PASSWORD = 2

LEVEL 2 PASSWORD = 5

To enter the password of 02 for Level 1 and 05 for Level 2:

1. From the BurnerLogix main menu (see Figure 4), use the NEXT or BACK keys to get to BOILER PARMS>.
2. Press the MODE key to access the BOILER PARMS sub-menu.
3. The first item displayed will be either UNITS OF MEASUREMENT or DISPLAY UNITS.
4. Press the NEXT key to display ENT LVL1 PW.
5. Press the RESET/MDFY key to enter modify mode.
6. Press the UP arrow to move the value to 2.
7. Press RESET/MDFY to save the value.
8. The display will automatically advance indicate ENT LVL2 PW.

9. Press the RESET/MDFY key to enter modify mode.
10. Press the UP arrow to move the value to 5.
11. Press the RESET/MDFY key to save the value.
12. Press the NEXT key and the display must read SET LVL1 PW to indicate the password was entered correctly. If not start over at step 4.
13. Pressing the MODE key will exit the BOILER PARMS sub-menu and return to the main menu. The password will remain enabled for 5 minutes or an additional 5 minutes every time any key on the keypad is pressed.

FIGURE 7. BOILER PARMS SUB-MENU

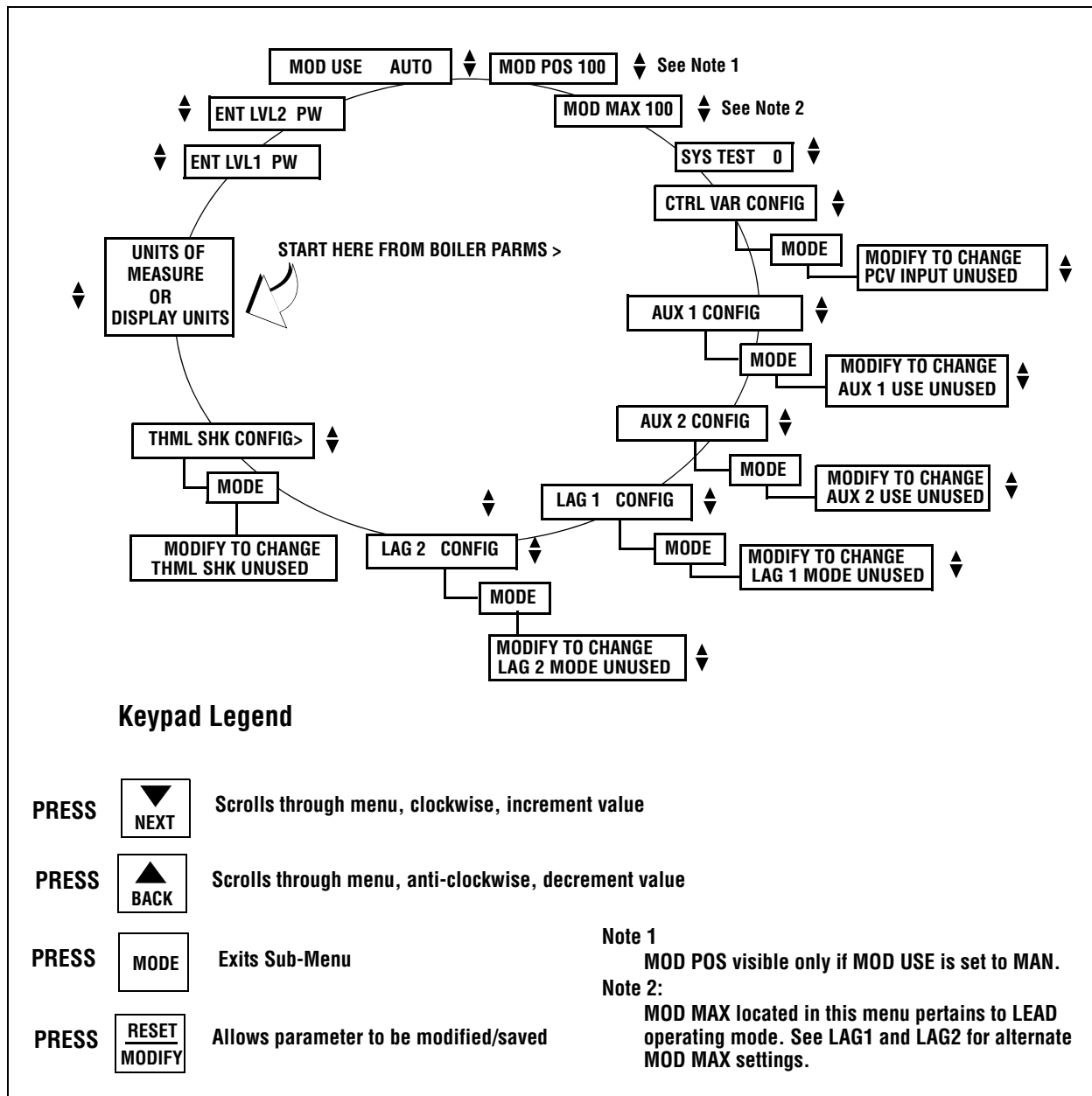

UNITS OF MEASURE / DISPLAY UNITS

The BurnerLogix system provides the user with the option of working in ENGLISH or METRIC units. This parameter applies to both pressure and temperature units. With all boiler parameters set to UNUSED (out of the box condition), the item UNITS OF MEASURE will be available to select ENGLISH or METRIC. After this choice has been made and the pressure or temperature sensor has

been selected, UNITS OF MEASURE will be replaced by DISPLAY UNITS. This item can be selected anytime as ENGLISH or METRIC but applies only to dynamic readings of pressures or sensor values. That is, all programmed parameters will be stored in units according to the previously selected UNIT OF MEASURE choice. The only method to change UNITS OF MEASURE is to reset all parameters back to the out of the box condition, erasing all currently programmed settings. This is done through the SYSTEM TEST key.

SYSTEM TEST

The BurnerLogix contains some useful functions that are only accessible through the SYSTEM TEST parameter.

SYSTEM TEST PARAMETER	DESCRIPTION
0	No action, has no function. Allows user to exit MDFY mode with no action being taken.
2	Immediately disables the enabled passwords. Both Level 1 and Level 2 passwords will need to be re-entered to modify protected variables. Has no effect if both passwords are set to 0 (i.e. no password is enabled).
245	Reset all System Variables back to system factory default values.

CONTROL VARIABLE CONFIGURATION SUB-MENU

The CTRL VAR CONFIG> sub-menu allows the user to select and setup the Primary Control Variable, pressure or temperature. All parameters in this sub-menu are password protected. The values of other sub-menus, such as LAG 1 and THERMAL SHOCK, are dependent on the selections made in this sub-menu. The STPT value is the target value the BurnerLogix will attempt to maintain. CUT IN is a differential value that is subtracted from the STPT and determines the point where a burner cycle begins. CUT OUT is a differential value that is added to the STPT and determines the point where a burner cycle ends. MOD RNG is a differential value and is subtracted from the STPT and determines the proportional band or response curve (slope) of the firing rate motor. A small value of MOD RNG will make the burner more responsive to process load changes. Care should be taken in selecting the proper value of MOD RNG as a system too responsive could cause overshoot and therefore short cycling of the burner. Both INTEGRAL and DERIVATIVE terms are used to eliminate steady-state error and reduce overshoot. They each have a range of 0 to 100%. This value determines how much of the error to factor in the calculation. A value of 0 turns the function off.

FIGURE 8. CONTROL VARIABLE CONFIGURATION SUB-MENU

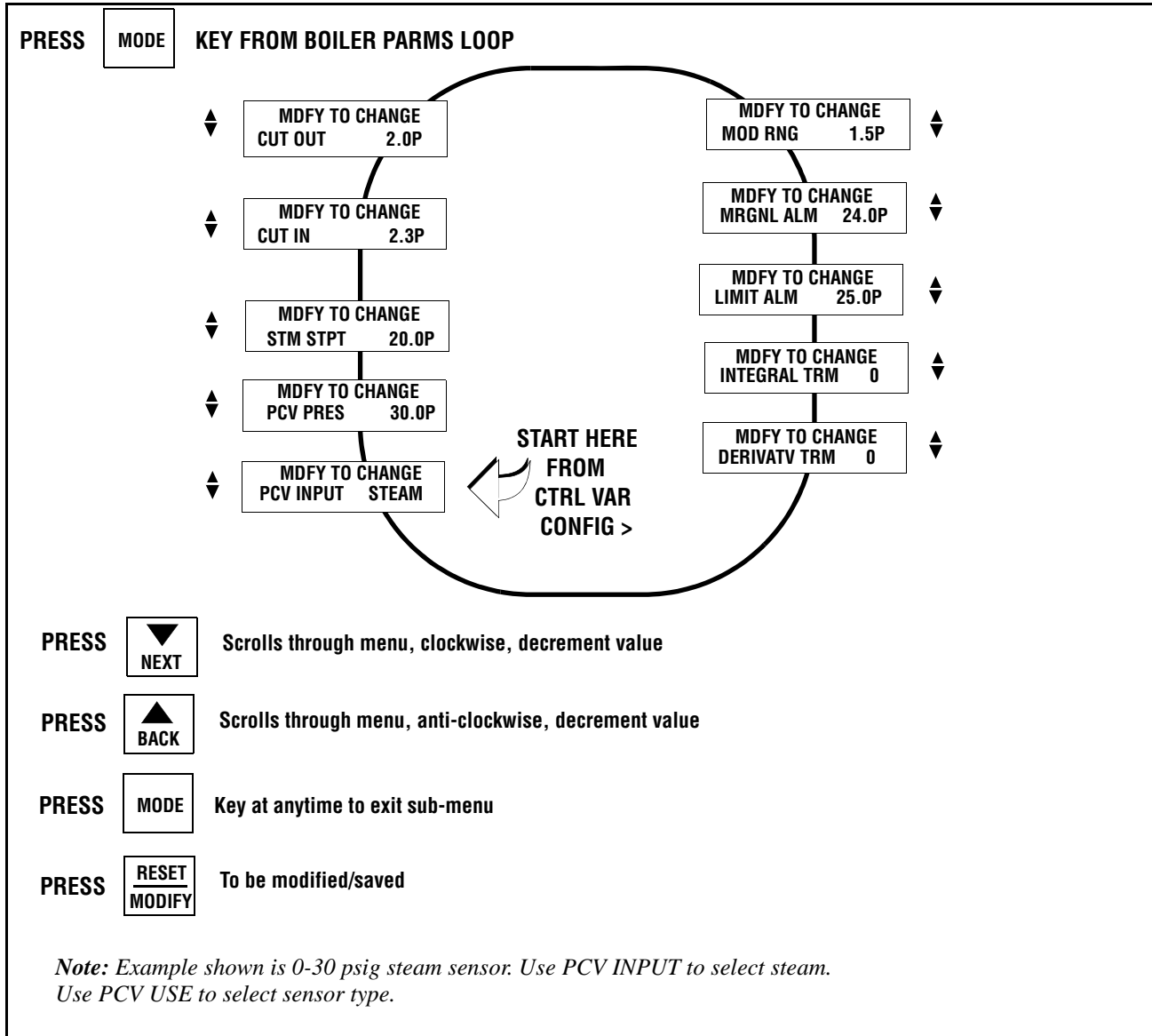

When selecting these values, the following rules may prove helpful:

1. Select a value of MOD RNG to give desired result
2. Add a derivative term to improve (reduce) the overshoot
3. Add an integral term to eliminate the steady-state error
4. Adjust MOD RNG, INTEGRAL, and DERIVATIVE until the desired overall response is obtained.

Keep in mind that it is NOT necessary to implement all three variables (proportional, derivative, and integral) into a single system. For example, if a PI controller gives a good enough response, then you don't need to implement derivative controller to the system.



SEQUENCE OF OPERATION - OPERATING CONTROL

Note: Refer to Figure 9.

The BurnerLogix performs the operating control function to cycle the boiler on and off to maintain the programmed pressure or temperature setpoint. The BurnerLogix will command the burner on and off according to the following setpoints located in the CONTROL VAR CONFIG sub-menu:

STM STPT 1 (Steam Pressure Setpoint) - This determines the steam pressure the BurnerLogix will maintain the boiler.

or

WTR STPT 1 (Water Temperature Setpoint) - This determines the water temperature the BurnerLogix will maintain the boiler.

CUT IN (Cut In Value) - Determines the point in which the steam pressure (or water temperature) must reach to start a burner cycle. This is a differential value that is subtracted from the steam pressure setpoint (**STM STPT**) or water temperature setpoint (**WTR STPT**).

CUT OUT (Cut Out Value) - Determines the point in which the steam pressure (or water temperature) must reach to end a burner cycle and initiate a normal shutdown. This is a differential value that is added to the steam pressure setpoint (**STM STPT**) or water temperature setpoint (**WTR STPT**).

Refer to Figure 8. When the steam pressure (or water temperature) is above the cut out point (Point "E"), system demand is satisfied and the BurnerLogix will be in Standby mode. As system demand increases and the steam pressure (or water temperature) falls below the cut in point (Point "D" - see note below), the BurnerLogix will initiate a burner cycle.

*Note: The cut in setpoint (**CUT IN**) is a differential value. Point "D" (steam pressure or water temperature in which the operating control closes) is determined by **subtracting** the cut in setpoint (**CUT IN**) from the steam pressure setpoint (**STM STPT**) or water temperature setpoint (**WTR STPT**).*

In Figure 8, the Cut In setpoint (**CUT IN**) is programmed to zero, so the cut in point for the operating control (Point "D") is the same as the Steam Pressure Setpoint (**STM STPT**). Burner cut in, cut out and setpoint are matter of preference and expected boiler performance.

When all other circuits within the Operating Control circuit, L1-3, of the BurnerLogix are closed, a burner start-up sequence will be initiated. See Figure 18 for suggested wiring diagram. A burner set-up sequence consists of Pre-Purge, Pilot Trial For Ignition, and Main Trial For Ignition (MTFI). Upon completion of the MTFI, the BurnerLogix moves to AUTO and the firing rate motor is controlled according to the user programmed setpoint parameters. (see SEQUENCE OF OPERATION - MODULATING CONTROL section).

Whenever the steam pressure (or water temperature) rises above the cut out point (Point "E" - see note below), the BurnerLogix will initiate a normal shutdown sequence (e.g.: de-energize main fuel valve, drive the firing rate motor to low fire) and proceed through post purge and back to Standby.

*Note: The cut out setpoint (**CUT OUT**) is a differential value. Point "E" (steam pressure or water temperature in which the operating control opens) is determined by **adding** the cut out setpoint (**CUT OUT**) to the steam pressure setpoint (**STM STPT**) or water temperature setpoint (**WTR STPT**).*

FIGURE 9.

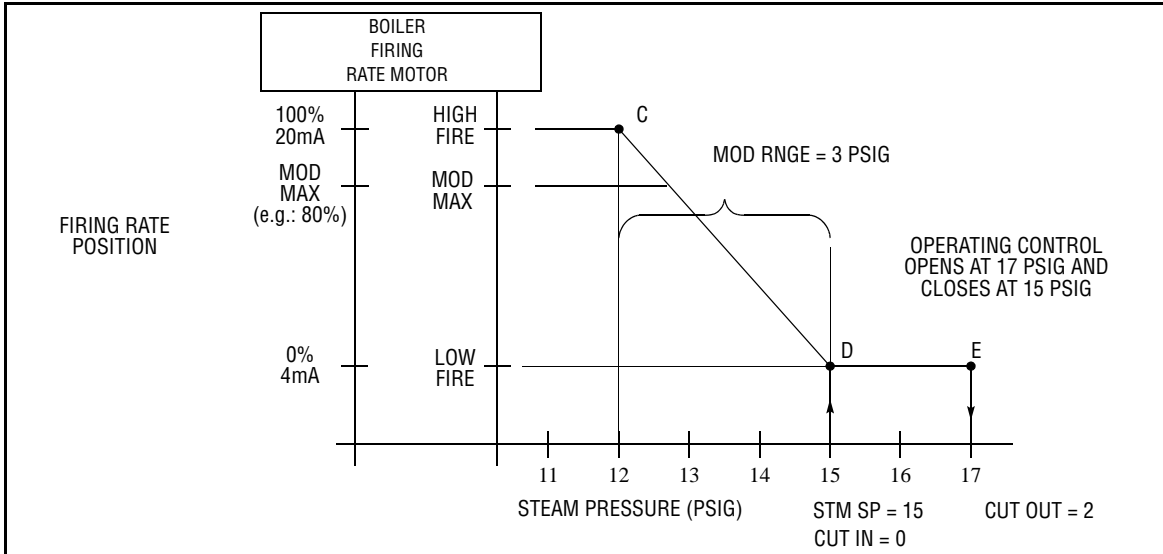

SEQUENCE OF OPERATION - MODULATING CONTROL

Note: Refer to Figure 10.

The BurnerLogix also performs the modulating control function of the firing rate motor based on system demand. The position of the firing rate motor will operate according to the following set-points:

STM STPT₁ (Steam Pressure Setpoint) - This determines the steam pressure the BurnerLogix will maintain the boiler. When the steam pressure is at this setpoint value, the firing rate motor is at the low fire position (0%).

or

WTR STPT₁ (Water Temperature Setpoint) - This determines the water temperature the BurnerLogix will maintain the boiler. When the water pressure is at this setpoint value, the firing rate motor is at the low fire position (0%).

MOD RNG (Modulating Range) - This determines the range of steam pressure (or water temperature) in which the firing rate motor is commanded from its low fire (0%) to its high fire position (100%). This is a differential value that is **subtracted** from the steam pressure setpoint (**STM STPT**) or water temperature setpoint (**WTR STPT**).

MOD MAX (Maximum Modulating Firing Rate Position) - This restricts the 4-20mA control signal to the firing rate motor.

*Note: The modulating range setpoint (**MOD RNG**) is a differential value. Point "C" (Steam pressure or water temperature in which the firing rate motor is at the high fire position) is determined by **subtracting** the programmed value of the modulating range (**MOD RNG**) from the Steam Pressure Setpoint (**STM STPT**) or Water Temperature Setpoint (**WTR STPT**).*

If the steam pressure (or water temperature) is:

- Between Points D and E, the firing rate motor is in the low fire position.
- Between points C and D, the firing rate motor position is determined by the slope of the line C-D. The slope of this line is determined by the value programmed for the setpoint **MOD RNG**.
- Lower than Point C, the firing rate motor is in the high fire position (100% or value determined by **MOD MAX**).

Whenever the steam pressure (or water temperature) is within the Modulating Range, an increase in pressure (or temperature) value will reduce the control signal to the firing rate motor, causing the

motor (or valve actuator) to drive towards its closed or low fire position. Similarly, a decrease in the steam pressure (or water temperature) will increase the control output signal, causing the valves and dampers to move toward their open or high fire position.

The value of the modulating range (**MOD RNG**) determines how the BurnerLogix responds to changes in the measured variable (steam pressure or water temperature). A small modulating range will cause the control to respond quickly to small changes in steam pressure or water temperature. A small value of **MOD RNG** might result in the firing rate motor to cycle excessively and possibly cause the burner to actually short cycle. A large value would reduce the cycling of the firing rate motor, but may cause the system to be somewhat sluggish in response to a change in steam pressure or water temperature. Matching the capacity of the boiler to load system demand are important considerations in setting the **MOD RNG** setpoint. Care should be taken when selecting this variable.

The BurnerLogix control also provides PID control (Proportional + Integral+ Derivative) to improve system response to varying load changes. Refer to “Proportional plus Integral plus Derivative control.

Maximum Modulating Firing Rate Position (MOD MAX)

The Maximum Modulating Firing Rate Position is a programmable setpoint which will clamp the 4-20mA control signal to the Firing Rate Motor. This setpoint will also affect the cycling rate of the boiler. This setpoint is programmed as a percentage, from 0% to 100%.

Manual Positioning of the Firing Rate Motor (MOD USE)

Although normal operation of the BurnerLogix system is to automatically control the modulating motor based on programmed set points, **MOD USE** provides the user the option of manually positioning the modulating motor. Manual control of the modulating motor is normally used in lieu of the standard manual / auto potentiometer found on older burner cabinets. At times it may be desirable to either limit the firing rate or base load one boiler in a multiple boiler environment.

The **MOD USE** setpoint has two selections: **AUTO** and **MANUAL**. The **AUTO** selection will have the BurnerLogix modulate the firing rate motor based on system demand. The **MANUAL** selection will allow the user to manually command the firing rate position. The current **MOD USE** state is displayed on the **ALL-INFO** screen.



CAUTION: As long as the setpoint MOD USE is programmed MANUAL, the BurnerLogix WILL NOT control the firing rate motor based on system demand, but will remain in manual control indefinitely.

Modulate Motor Position (MOD POS)

Use this setpoint to manually position the modulator (firing rate) motor. The motor will move as long while the NEXT or BACK key are depressed. Use the RESET/MDFY key to save the position.

MOD USE, **MOD POS** and **MOD MAX** setpoints are all located in the BOILER PARMS submenu. MOD POS is displayed only if MOD USE is set to MAN.

To manually position the firing rate motor:

1. While in STANDBY and with burner off, and from the ALL-INFO screen, pressing the MODE key will move to the top of the BurnerLogix Main menu where L1-3 OPEN or L1-3 CLOSED is displayed. Pressing MODE again will move the display to either MOD USE if in AUTO mode or to MOD POS if in MAN mode. If changing to MAN mode, press the RESET/MDFY key and the NEXT or BACK key to change to MAN and then the RESET/MDFY key to save the change. Press the NEXT key to move to MOD POS and then the RESET/MDFY key to manually position the firing rate motor. When complete, press the RESET/MDFY key to save the position. Pressing the MODE key will move the display to the top of the BurnerLogix Main menu screen and then to the ALL-INFO screen.
2. While in AUTO or main firing period, and from the ALL-INFO screen, pressing the MODE key will move directly to either the MOD USE if in AUTO mode or to MOD POS if in MAN mode. If changing to AUTO mode and at MOD POS screen, use the BACK key to move to MOD USE

and make change to AUTO. If currently in MAN mod and at MOD POS screen, press the RESET/MDFY key and either the NEXT or BACK key to manually change the current firing rate position. The firing rate motor will move while the NEXT or BACK keys are depressed. When complete, press the RESET/MDFY key to save the position. Pressing the MODE key will move the display to the top of the BurnerLogix Main menu screen and then to the ALL-INFO screen.

The BurnerLogix system has *bumpless* transfer. If the burner is at the AUTO position and the current modulating mode is changed from AUTOMATIC (AUTO) to MANUAL (MAN) mode, MOD POS will assume the value of the current firing rate position. The operator can change the position to any value through the MOD POS option that follows the MOD USE option in the menu. On the subsequent burner cycle, the firing motor will move to the saved MOD POS value when it gets to AUTO.



IMPORTANT: In the event the Primary Control Variable (PCV) pressure or temperature transducer fails in such a manner as to output less than 4 mA or becomes disconnected, the BurnerLogix Z system will immediately shutdown and proceed to lockout with the message PCV UNDER RANGE displayed. However, as boiler output is critical, and a replacement transducer may not be immediately available, the user may continue to operate the boiler if MOD USE is placed in the MANUAL position and the control is reset from lockout. The firing rate position can now ONLY be manually controlled until a replacement transducer is located and installed. The user must be cautioned the BurnerLogix Z system has no way of knowing the operating pressure of temperature and it is up to the user to limit the output of the boiler.

SEQUENCE OF OPERATION - MARGINAL AND HIGH ALARM LIMITS

The PCV, AUX1 and AUX2 sensors installed with the BurnerLogix provide both high marginal alarm and high limit alarm functions. The marginal limit can be used to provide an indication that the sensor value is approaching the high alarm limit before the alarm limit is actually reached. For example, a Marginal Stack Alarm may be an indication of the burner overfiring, fouled heat exchanger, tube leak in heat exchanger, etc.



WARNING: The electro-mechanical steam pressure or water temperature high limit switch MUST remain in the running interlock circuit (3-P).

WARNING: Programming a sensor range that is different from the actual range of the installed sensor could result in improper operation.

The user can program both high marginal and high limit alarm setpoints for the temperature or pressure sensors based on the input signal received. If the temperature or pressure exceeds the marginal high limit for 4 seconds, the alarm output relay will be activated, and the system will remain on line. If the temperature or pressure high limit alarm is exceeded the BurnerLogix will proceed to lockout requiring manual reset.

The marginal high setpoint cannot be set higher than the high limit alarm setpoint nor can either be set lower than the sum of setpoint (STPT) plus cut out (CUT OUT). Alarm points for stack monitoring can be set anywhere within the sensor range to meet the application. The marginal high limit and high limit alarm setpoints are shown on the display as MRGNL ALM and LIMIT ALM respectively.

SEQUENCE OF OPERATION - COLD START THERMAL SHOCK PROTECTION

Cold Start Thermal Shock Protection is designed to slowly increase the burner firing rate on a cold start to limit mechanical stress due to thermal differences. The BurnerLogix offers two methods of thermal shock protection: Low Fire and Segment. Thermal shock parameters are found in the BOILER PARMS menu in the THERMAL SHK CONFIG sub-menu. The setpoints associated with selecting this function are:

- **THML SHK** (Thermal Shock Protection): This setpoint enables the thermal shock protection function. The selections are **UNUSED**, **LOW FIRE** and **SEGMENT**.
- **LOW FIRE METHOD**: This method of cold start thermal shock protection is generally used on Water Tube Boilers. The setpoints associated with this method of thermal shock protection is:
 - **THML EXIT** (Thermal Shock Exit Setpoint): The BurnerLogix will hold the Firing Rate motor in the low fire (LF) position until the steam pressure (or water temperature) reaches the Thermal Shock Exit Setpoint (**THML EXIT**). Once this steam pressure (or water temperature) is reached, the firing rate motor is positioned according to the modulating control algorithm. See Figure 6.
 - **THML LF%** (Low fire minimum): Use this selection to set the firing rate motor position during the low fire method operation.

Note: If AUX1 is programmed for STNDBY WTR, Thermal Shock Protection - Low Fire Method will control according to boiler water temperature and not steam pressure. See SEQUENCE OF OPERATION - STANDBY WATER section.

FIGURE 10. Cold Start Thermal Shock Protection - Low Fire Method

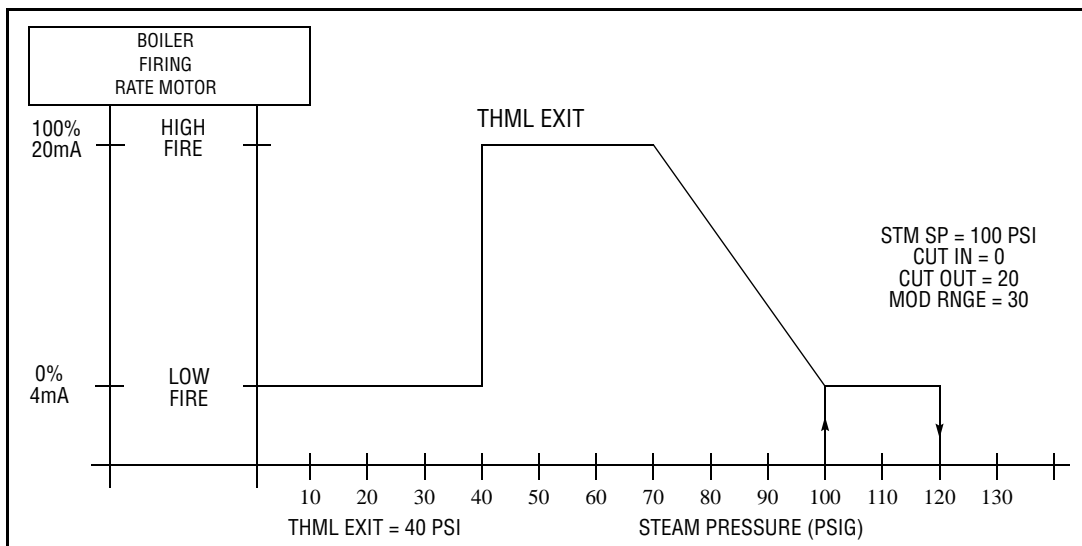

- **SEGMENT METHOD**: This method of cold start thermal shock protection is generally used with Fire Tube Boilers. The setpoints associated with this method of thermal shock protection are:
 - **THML STRT** (Thermal Shock Start Point): Determines the start point for thermal shock protection.
 - **THML EXIT** (Thermal Shock Exit Point): Determines the exit point for thermal shock protection.
 - **THML OVRD** (Timed Override Per Segment Setpoint): Determines maximum time BurnerLogix holds the firing rate for each segment before increasing to the next segment.

THML STRT and THML EXIT: Once the burner cycle starts, the BurnerLogix will hold the firing rate motor in the low fire position until the steam pressure (or water temperature) reaches the Thermal Shock Start Point (**THML STRT**). The BurnerLogix then automatically divides the difference between the high fire position and low fire position into sixteen (16) segments. The BurnerLogix also divides the difference between the Thermal Shock Exit Point (**THML EXIT**) and Thermal Shock Start Point (**THML STRT**) into sixteen (16) segments. The BurnerLogix will increase the firing rate motor by the value of one segment, and wait until the steam pressure (or water temperature) increases by the amount of one segment. Once the steam pressure (or water temperature) increases by the calculated amount, the BurnerLogix increases the firing rate motor by the value of one seg-

ment and repeats the process. The BurnerLogix steps the firing rate motor until the steam pressure (or water temperature) reaches the Thermal Shock Exit Point (**THML EXIT**). At that point, the firing rate motor is at the high fire position, and will remain at the high fire position until the steam pressure (or water temperature) reaches the modulating range (**MOD RNG**). See **SEQUENCE OF OPERATING - MODULATING CONTROL** section.

*Note: If AUX1 is programmed for **STNDBY WTR**, Thermal Shock Protection - Segment Method will control according to boiler water temperature and not steam pressure. See **SEQUENCE OF OPERATION - STANDBY WATER** section.*

THML OVRD: The Timed Override Per Segment Setpoint (**THML OVRD**) allows the user to program a maximum time period in which the control will try to increase the steam pressure (or water temperature) at a specific firing rate position. If the steam pressure (or water temperature) DOES NOT increase to the appropriate value, the BurnerLogix will automatically advance the firing rate position to the next position.

FIGURE 11. Cold Start Thermal Shock Protection - Segment Method

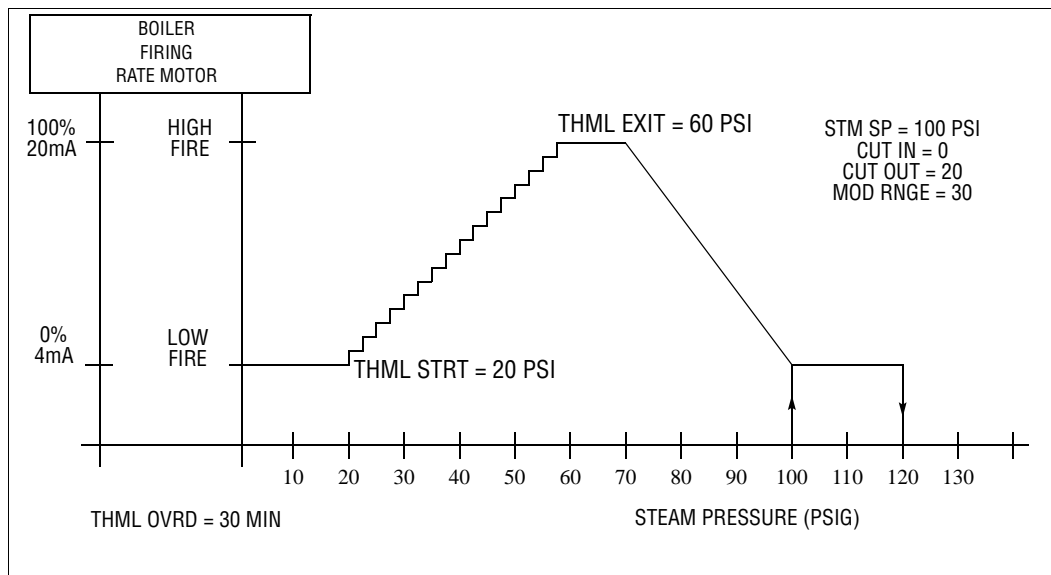

SEQUENCE OF OPERATION - LEAD/LAG CONTROL

In installations having multiple boilers, the BurnerLogix of each boiler can be set up to operate in a Lead/Lag mode of operation. The BurnerLogix control provides two lead/lag setpoints, LAG1 and LAG2, each made active by separate 120 VAC digital inputs located on terminals 16 and 21. Please note these inputs have multiple uses and must be programmed as LAG to utilize this function. The function of Lead or Lag operation is determined by the status of a maintained 120 VAC wired to Terminals 16 and 21. The logic table for Lead and Lag operation is as follows:

LAG 1 (16)	LAG 2 (21)	OPERATING MODE
0	0	LEAD
120 Vac	0	LAG 1
Don't care	120Vac	LAG 2

With both inputs open, the BurnerLogix will operate in the LEAD mode. The current operating mode, (LEAD, LAG1 or LAG2), is displayed on the ALL-INFO screen. LAG1 and LAG2 setpoints are found in the **BOILER PARMS**> menu under **LAG1 CONFIG**> and **LAG2 CONFIG**> respectively. Assuming LAG1 operation is selected, the BurnerLogix will control according to the following setpoints:

LAG1 STPT (Lag Setpoint for Water Temperature or Steam Pressure): This is the system setpoint the BurnerLogix will maintain when it is selected for Lag Operation.



CUT IN (Cut In): This is the setpoint where the BurnerLogix will close its operating control when operating as the Lag1 Boiler. This is a differential value that is **subtracted** from the Lag1 Setpoint (**LAG1 STPT**). When this value is set to zero, the Lag Boiler will close its operating control contacts at the programmed Lag Setpoint (**LAG1 STPT**).

CUT OUT (Cut Out): This is the Cut Out value the BurnerLogix will use during Lag1 Operation. This is a differential value that is **added** to the Lag Setpoint **LAG STPT**). See SEQUENCE OF OPERATION - OPERATING CONTROL section.

MOD RNG (Modulating Range): This is the Modulating Range the BurnerLogix will use during Lag1 Operation. This is a differential value that is **subtracted** from the Lag1 Setpoint (**LAG1 STPT**). See SEQUENCE OF OPERATION - MODULATING CONTROL section.

STRT DLY (Lag To Start Delay): A time delay (0 to 15 minutes) from when the control variable falls below the cut in value to when the burner is commanded to initiate a burner start cycle. The object of this function is to allow the LEAD boiler time to recover from a change in load demand. During this delay period, the display screen will indicate the starting delay time and count down to 0 as follows:

STANDBY 1:34
LAG1 DELAYED

LAG DLY (Lead to Lag Delay): When a BurnerLogix control is commanded to go from LEAD Operation to LAG Operation (based on the status of terminal 16 or 21), LEAD operation will continue for this user settable delay (0 to 15 minutes) before switching to LAG operation. The purpose for this delay is it allow sufficient time for the “New Lead” Boiler to prepare to meet demand. During this period the ALL-INFO display will indicate –

8.4P AUTO 52%
LEAD>LAG1 FLM42

MOD MAX (Modulator Motor Maximum): Both LAG 1 and LAG 2 allow the modulating motor travel to be separately limited to a value of 0 to 100%. This can be useful where the maximum firing rate for an alternate fuel needs to be limited. Another use may be limited firing during an off peak or low fire use period, i.e. weekends, holidays, etc.

LAG CUT IN: The cut in setpoint (**CUT IN**) provides the two options for programming how the Lag Boiler will respond to a call in demand. Programming the cut in setpoint to zero will close the operating control at the Programmed Lag Setpoint for Steam Pressure or Hot Water (**LAG1 STPT**). This would cause the lead and lag boilers to operate as shown in Figure 9. By programming a value greater than zero for this setpoint, the user can program the Lag Setpoint for Steam Pressure or Hot Water (**LAG SP**) the same as the Steam Pressure Setpoint (**STM STPT**) or Water Temperature Setpoint (**WTR STPT**) as the Lead Boiler. This would cause the lead and lag boilers to operate as shown in Figure 12 and Figure 13.)

FIGURE 12.

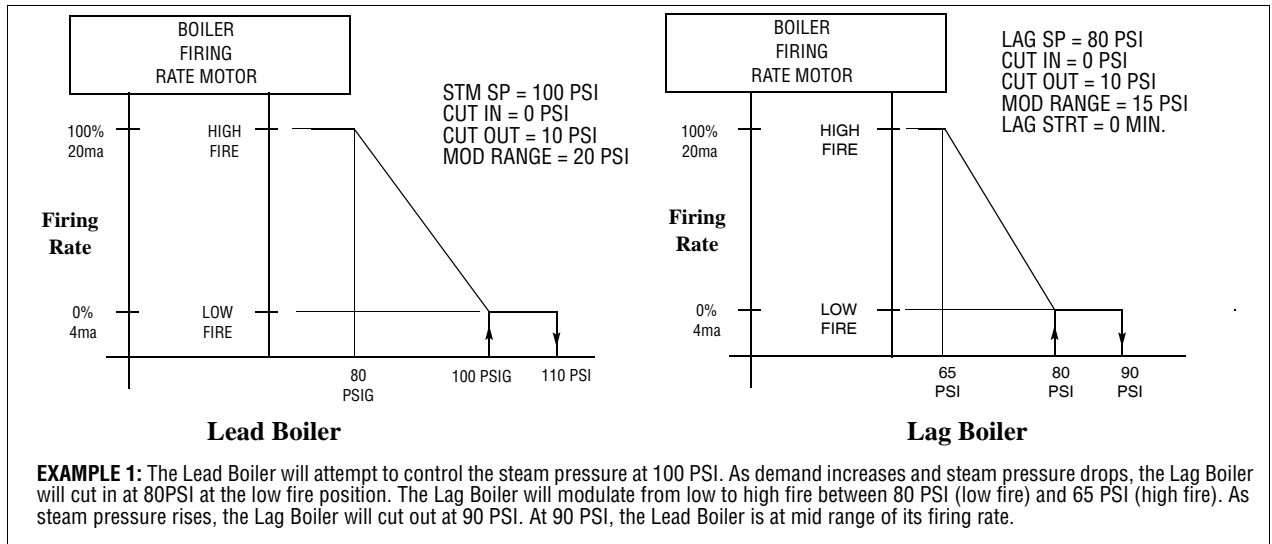
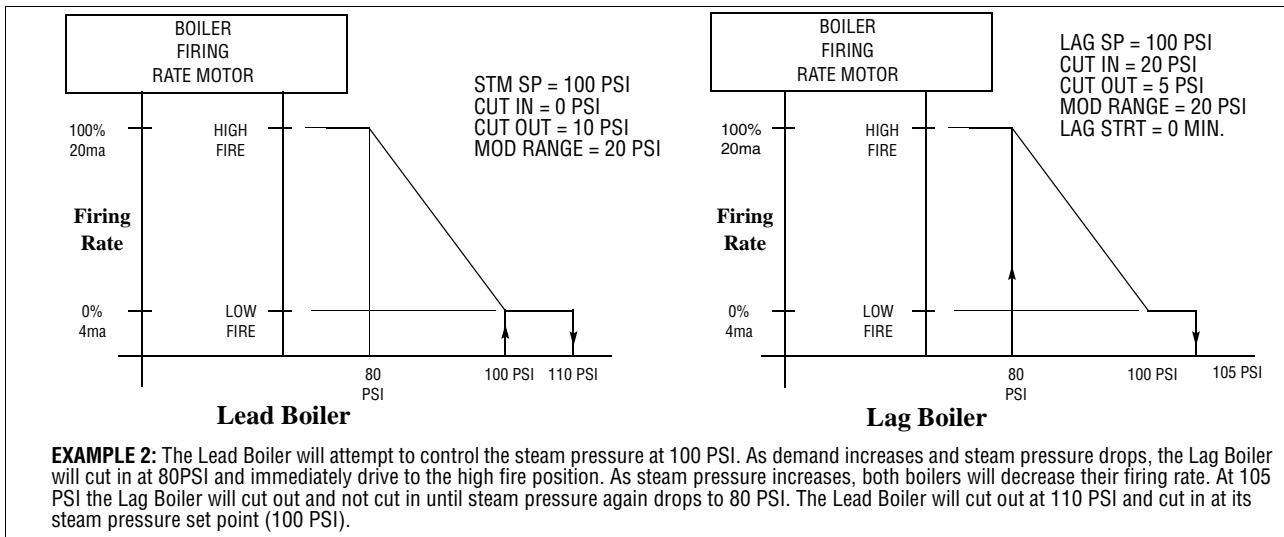

FIGURE 13.



Standby Water

When a steam boiler is operating as the Lag Boiler in a Lead/Lag setup, the BurnerLogix can be programmed to monitor the boiler water of the Lag steam boiler and bring the boiler on-line when the boiler water temperature falls below a programmed setpoint. This way, the Lag boiler will be ready to come online to support the Lead boiler and be ready to generate steam pressure as needed. See SEQUENCE OF OPERATION - STANDBY WATER section.

ALTERNATE USES FOR LAG2 INPUT

In addition to providing a second lag input on terminal 21, where this is not necessary, the LAG2 input may be user programmed for alternate uses. These alternate uses are **RESET**, **P-HOLD**, **I-HOLD**, **PROCESS** and **FRCD ON**. Terminal 21 is a line voltage isolated input operating at 120 VAC. These are selected through the BOILER PARMS menus inside the LAG2 sub-menu and are described as follows:

1. **RESET** – Depressing and releasing a reset push button will cause the unit to reset from lockout or cause the control to shut down the burner and recycle.

2. **P-HOLD** – When this input is active (energized), the BurnerLogix system will hold in the pilot stage during start up and will only advance to MTFI when the input is de-energized.
3. **I-HOLD** – When this input is active and if the firing state is AUTO, the BurnerLogix system will drive the firing rate to 0% and hold the burner in the low fire position.
4. **PROCESS** – When this input is active (energized), the BurnerLogix will operate in the following manner:
 - a. During burner start up, the BurnerLogix system will hold in the pilot stage during burner start up. De-energizing the input (terminal 21) will force the unit through MTFI back into the AUTO position.
 - b. While in the AUTO or main firing position, this input will force the BurnerLogix system to drop back to the pilot hold stage by first dropping back to the low fire position, proving the M-D low fire start input, energizing the pilot valve and ignition transformer and after a stabilizing delay of 20 seconds, de-energize the main valve and do a PTFI sequence in accordance with the PTFI*MTFI TIMING selection. After PTFI, the system will remain in the pilot hold mode with only the pilot valve (terminal 6) energized. De-energizing the input (terminal 21) will force the unit through MTFI back into the AUTO position.



The user shall contact the burner manufacturer to determine if the pilot assembly is rated for intermittent operation.

5. **FRCD ON** – The purpose of FRCD ON (forced on) is to provide an input that can be controlled by a smart lead/lag controller and if it is determined the lead boiler needs assistance to maintain load demand, the lag boiler can then be forced into service.
 - a. Burner turn on
With FRCD ON input inactive, the boiler will turn on if the control variable is below the **cut in** value.
With FRCD ON input active, the boiler will turn on if the control variable is below the **cut out** value.
 - b. Burner turn off
The boiler will shut down if the control variable is above the **cut out** value.
If the boiler has been firing due to an active FRCD ON, and if the FRCD ON state is changed to inactive, shut down will occur if the control variable is above the **cut in** value.

When LAG2 is set as FRCD ON, LAG 2 STRT DLY is used as a delay from when FRCD ON goes active (terminal 21) to when the command to start the burner is actually given.

If the burner is firing and FRCD ON input is made inactive and the firing rate is above 25%, shut down occur after the assured low fire cut off delay.

SEQUENCE OF OPERATION - STANDBY WATER

When the BurnerLogix is controlling a steam boiler, the water temperature sensor connected to the AUX1 input can be programmed to operate in a:

1. **Standby Lag Mode** to monitor the boiler water of a steam boiler operating as the Lag boiler in a Lead/Lag setup and cycle the boiler “on” to maintain the boiler water at a “Standby” temperature so the boiler is ready and available to come online and deliver steam to support the Lead boiler.
2. **Standby Thermal Shock Protection Mode** to monitor the boiler water of a steam boiler and slowly increase the burner firing rate on a cold start to limit mechanical stress based on the boiler water temperature instead of steam pressure. The first step is to install a water tempera-



ture sensor (P/N TS350-2, -4, or -8 or TS752-2, -4, or -8) on the steam boiler, connect it to the **AUX1** input, and program the sensor to operate in the **STNDBY WTR** mode.



WARNING: Location of the boiler water temperature sensor is critical in the operation of Standby Water. Consult the boiler manufacturer for guidance for its location or refer to Bulletin TS-3501 for proper location and wiring of this temperature sensor.

CAUTION: Programming the AUX 1 USE for STANDBY WTR automatically converts all of the setpoints associated with the operation of Thermal Shock Protection to UNUSED. See SEQUENCE OF OPERATION- COLD START THERMAL SHOCK PROTECTION section to set these values properly.

STANDBY LAG MODE

To program the BurnerLogix to control a steam boiler in the “Standby Lag Mode”, the user programs the following setpoints which are found under **AUX1 CONFIG**>:

STNDBY WTR: This selects the temperature sensor connected to the **AUX1** input terminals will be used to monitor the boiler water of a steam boiler and programmed to operate in the **STNDBY WTR** mode. See GETTING STARTED - Select and Program the Pressure and Temperature Sensor Ranges section.

STNDBY STPT (Water Temperature Setpoint): This determines the boiler water temperature the BurnerLogix will maintain.

CUT IN (Cut In Value): Determines the point in which the boiler water temperature must reach to close the operating control. This is a differential value that is **subtracted** from the water temperature setpoint (**WTR SP**).

CUT OUT (Cut Out Value): Determines the point in which the boiler water temperature must reach to open the operating control. This is a differential value that is **added** to the water temperature setpoint (**WTR SP**).

MOD RNG (Modulating Range): This determines the range of boiler water temperature in which the firing rate motor is commanded from its low fire to its high fire position.

The Standby mode of operation is similar to the operating control and modulating control functions. See SEQUENCE OF OPERATION - OPERATING CONTROL and SEQUENCE OF OPERATION -MODULATING CONTROL sections.

When **AUX1** is configured to be used as standby water, both lead or lag pressure and temperature inputs are monitored continuously with steam pressure having priority. Because both steam and water are active inputs, the BurnerLogix will operate the burner in the following manner:

1. While the standby water temperature is above its cut in point, the lead or lag steam pressure cut in point is monitored.
2. If the standby water temperature is above its cut in point and the lead or lag steam pressure is below its cut in point, the burner will operate and control according to the steam pressure setpoints.
3. If the standby water temperature is less than its cut in point and the lead or lag steam pressure is less than its cut in point then:
 - a. If thermal shock is active and the standby water temperature is less than the thermal shock exit point, the boiler will be controlled according to the thermal shock setpoints (temperature).
 - b. If the standby water temperature is above the thermal exit point, the boiler will be controlled according to the lead or lag steam pressure setpoints.
 - c. While the boiler is firing and the standby water setpoint is satisfied and if the steam pressure is below its setpoint then control is switched to the lead or lag steam pressure parameters.

4. If standby water temperature is less than its cut in value and the lead or lag steam pressure above its cut in value, then the boiler will operate according to the standby water parameters.

In Figure 14, whenever the boiler water temperature is above 190F (Cut out point), the Operating Control Output of the BurnerLogix is open. When the boiler water temperature falls to 180F (Cut in point), the Operating Control Output closes and a burner start-up sequence will be initiated. The BurnerLogix will modulate the firing rate damper motor based on boiler water temperature until the temperature rises above 190F (Cut out point).

FIGURE 14.

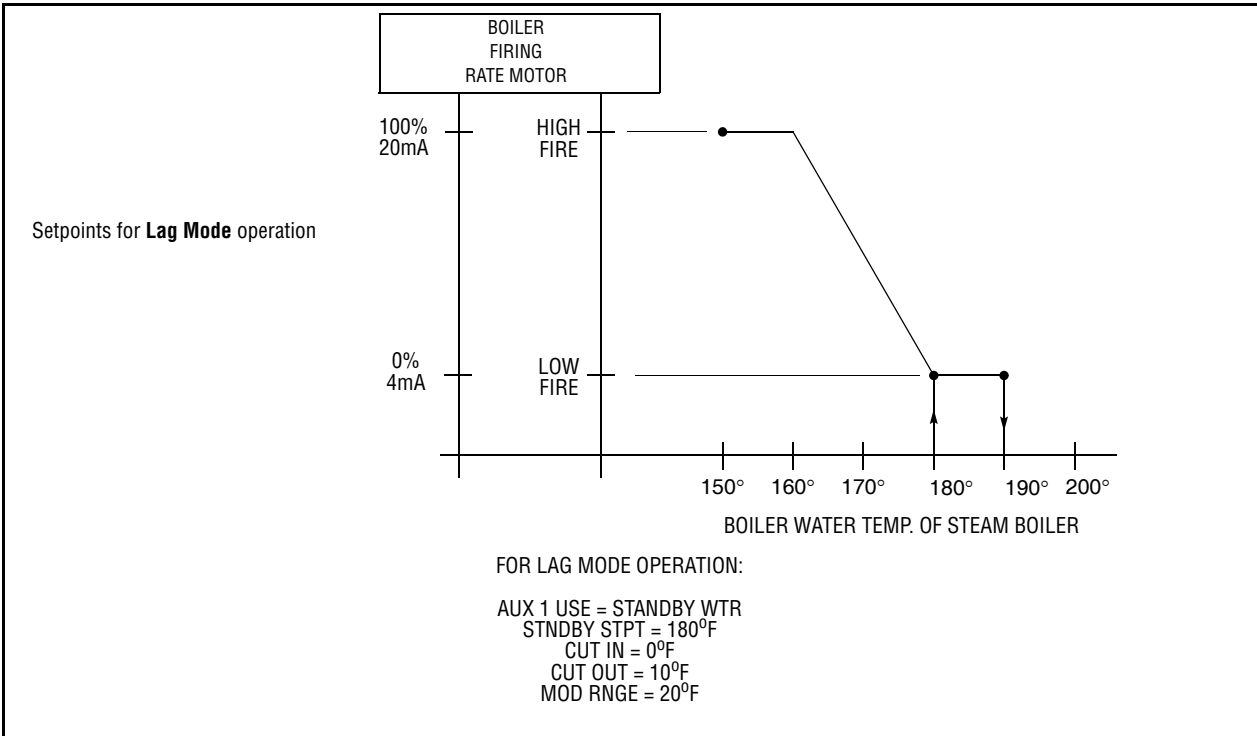

STANDBY THERMAL SHOCK PROTECTION MODE:

To program the BurnerLogix to control a steam boiler in the “Standby Thermal Shock Protection Mode” to perform thermal shock protection by monitoring the boiler water temperature instead of steam pressure, the user programs the following setpoints which are found under AUX1 SETPOINTS:

AUX1 USE: The temperature sensor connected to the **AUX1** input will be used to monitor the boiler water of a steam boiler. Program this setpoint to **STNDBY WTR**. See GETTING STARTED - SELECT AND PROGRAM THE PRESSURE AND TEMPERATURE SENSOR RANGES section.

After programming the AUX1 for STNDBY WTR selecting the appropriate temperature sensor, 350F or 752F, the following setpoints also need to be programmed: **STANDBY STPT**, **CUT IN**, **CUT OUT**, and **MOD RNG**.

Note: Once AUX1 CONFIG is programmed for STNDBY WTR, all THERMAL SHOCK setpoints will be set to temperature. If thermal shock is to be used, these setpoints must be properly programmed by the installer or operator. Refer back to the section discussing Thermal shock operation.

FIGURE 15.

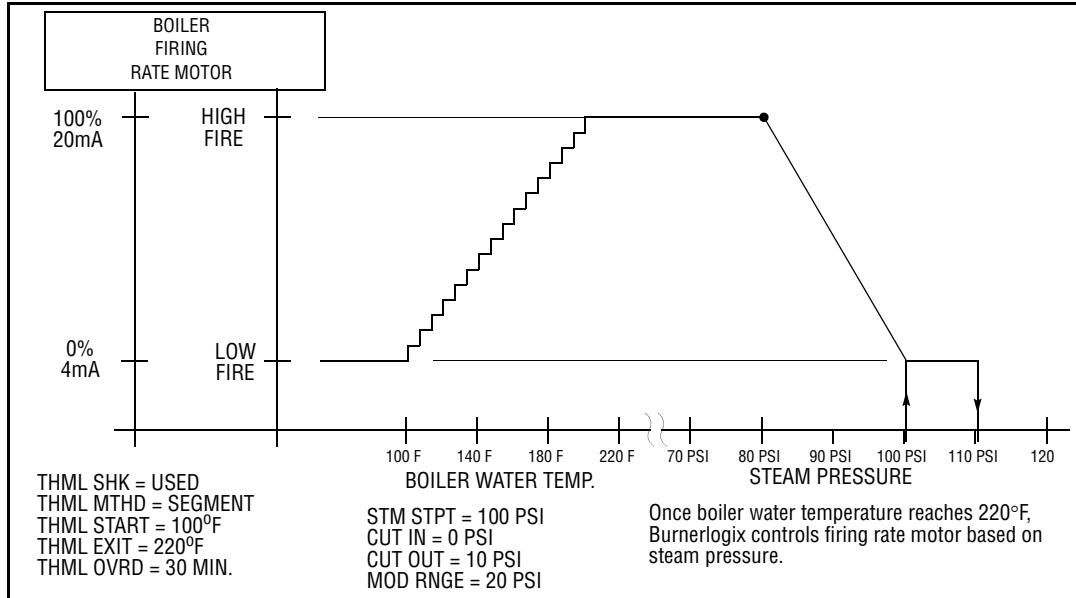

ALTERNATE USES FOR AUX 1 INPUT

AUX 1 input accepts any of the listed pressure or temperature sensors and can be utilized for a variety of purposes.

MONITORING PRESSURE - PRES

Using any of the listed pressure transducers, the user can monitor and display any pressure not related to the boiler steam pressure. For example, on an oil fired boiler the user may want to install to monitor burner oil pressure and have that information available to the display screen as well through modbus communications.

STANDBY WATER - STNDBY WTR

Only AUX 1 can be used for STANDBY WATER. Refer to the previous sections explaining the operation of STANDBY WATER.

MONITOR TEMPERATURE - MNTR

Using any of the listed pressure transducers, the user can monitor and display any temperature not related to the boiler water temperature. For example, on an oil fired boiler the user may want to install to monitor burner oil temperature or in a hot water system the return hot water. This information is to the display screen as well through modbus communication.

STACK TEMPERATURE - STACK

A temperature sensor can be installed to monitor the stack temperature of the boiler. A high limit alarm and marginal high limit alarm can be programmed for that sensor. When the high limit alarm is exceeded, the BurnerLogix Z system will shutdown and lockout the boiler. The appropriate alarm message will be displayed. When AUX 1 is selected as Stack Temperature (STACK TEMP), the user has the option of sensor range, 32-350F or 32-752F. The user then programs in the MARGINAL HIGH LIMIT (MRGNL STACK) followed by the HIGH LIMIT (LIMIT STACK).

FIGURE 16. AUX 1 SUB MENU

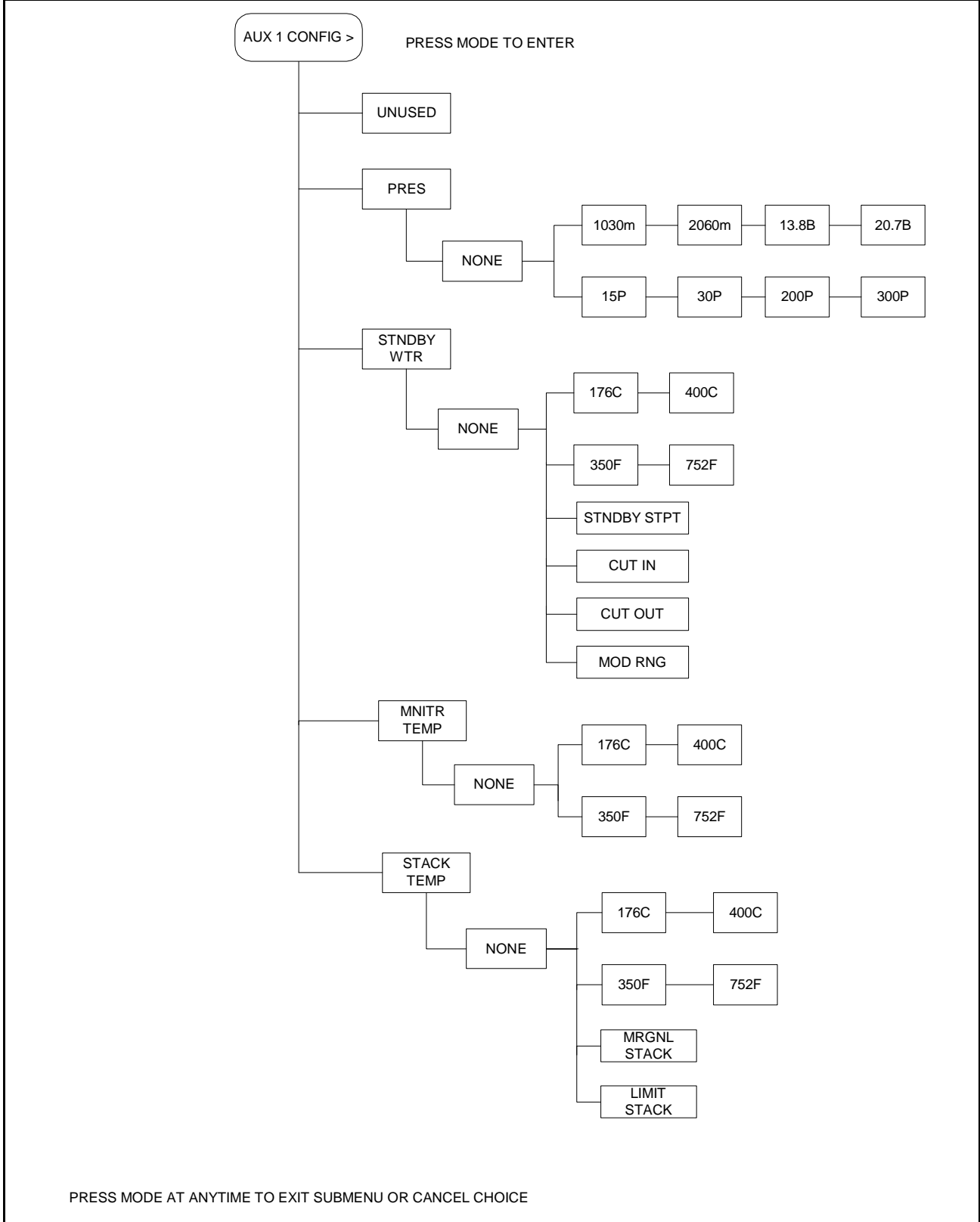



ALTERNATE USES FOR AUX 2 INPUT

AUX 2 input accepts any of the listed pressure or temperature sensors and can be utilized for a variety of purposes.

MONITORING PRESSURE - PRES

Using any of the listed pressure transducers, the user can monitor and display any pressure not related to the boiler steam pressure. For example, on an oil fired boiler the user may want to install to monitor burner oil pressure and have that information available to the display screen as well through modbus communication.

MONITOR TEMPERATURE - MNTR

Using any of the listed pressure transducers, the user can monitor and display any temperature not related to the boiler water temperature. For example, on an oil fired boiler the user may want to install to monitor burner oil temperature or in a hot water system the return hot water. This information is to the display screen as well through modbus communication.

MONITOR OUTDOOR TEMPERATURE - OUTDR

A temperature sensor can be installed to monitor outdoor air temperature. An operating inhibit setpoint (OUTDR STPT) can then be programmed so that when the outdoor air temperature is above this inhibit setpoint, the operating control circuit of the BurnerLogix Z system will not respond to system demand and initiate a burner cycle. While this condition exists the display will indicate OUTDR TEMP> STPT. The outdoor air temperature must fall three (3) degrees below the inhibit setpoint before the operating control circuit will respond to system demand. When AUX 2 is selected as Outdoor Temperature (OUTDR TEMP), the user has the option of sensor range, 32-350F or 32-752F. The user then programs in the OUTDOOR SETPOINT (OUTDR STPT).

STACK TEMPERATURE - STACK

A temperature sensor can be installed to monitor the stack temperature of the boiler. A high limit alarm and marginal high limit alarm can be programmed for that sensor. When the high limit alarm is exceeded, the BurnerLogix Z system will shutdown and lockout the boiler. The appropriate alarm message will be displayed. When AUX 2 is selected as Stack Temperature (STACK TEMP), the user has the option of sensor range, 32-350F or 32-752F. The user then programs in the MARGINAL HIGH LIMIT (MRGNL STACK) followed by the HIGH LIMIT (LIMIT STACK).

FIGURE 17. AUX 2 SUB MENU

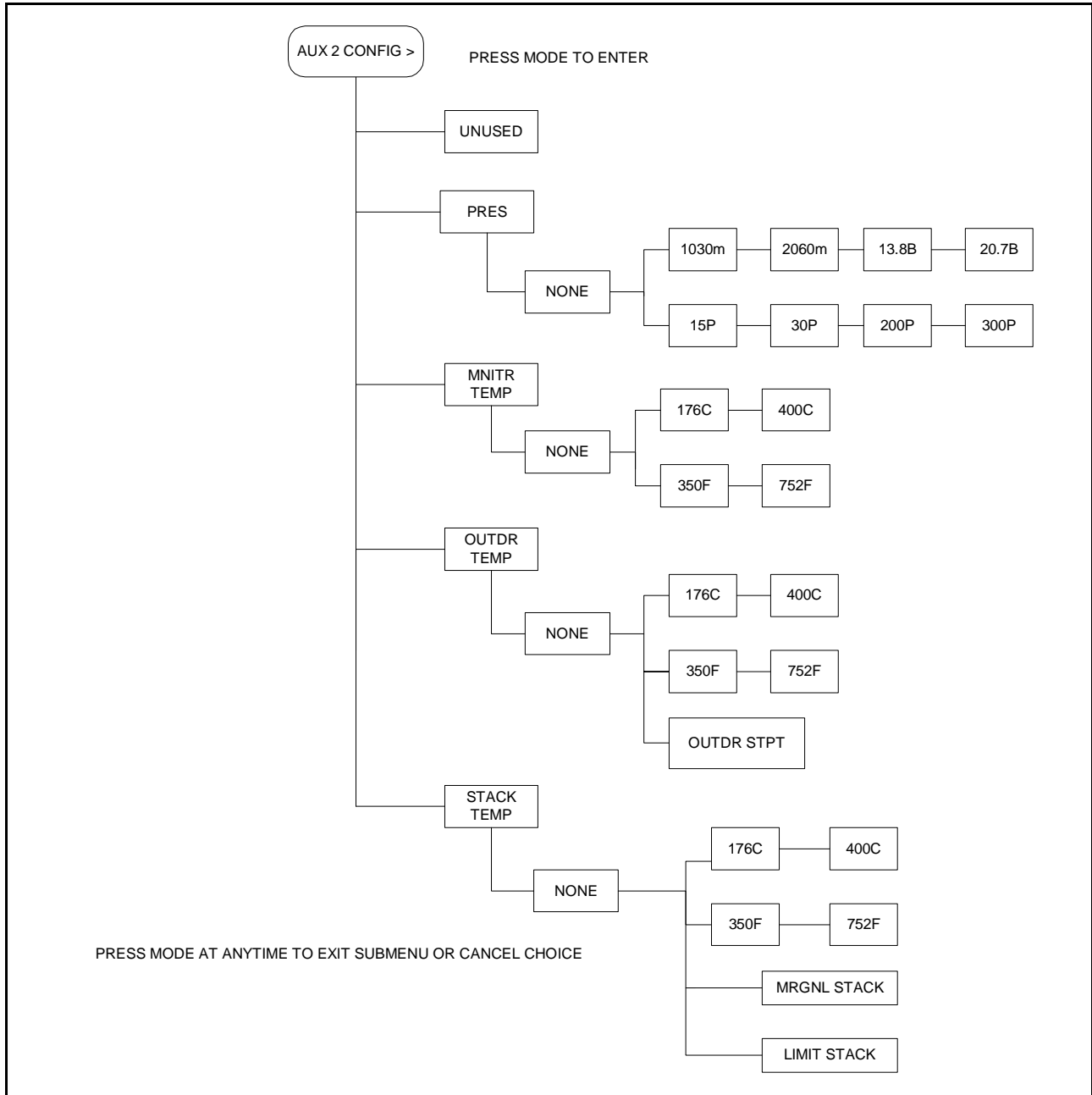

FLAME SCANNERS

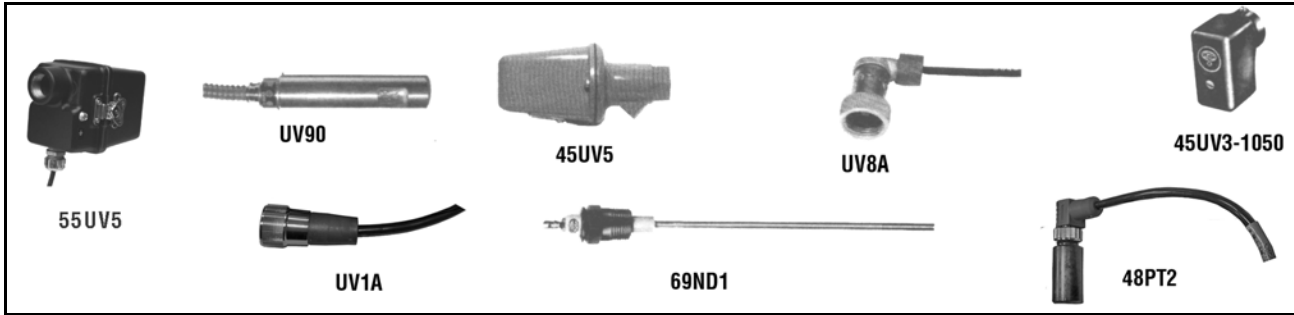

CAUTION: The UV1A, UV2, UV8A, UV90 and 45UV3 flame scanners and associated amplifier module are non-self checking UV systems and should be applied only to burners that cycle often (e.g.: a minimum of once per 12 hours) in order for the safety checking circuit to be exercised. If component checking is required during burner operation for constantly fired burners, utilize the self-checking ultra-violet flame scanners (45UV5, 55UV5) with associated amplifier module (ZB110UVSC), or the infrared flame scanner (48PT2) with associated Auto Check amplifier (ZB110IR activated).

INSTALLATION - UV SCANNERS

Where possible, obtain the burner manufacturer's instructions for mounting the scanner. This information is available for most standard burners. The scanner mounting should comply with the following general instructions:

1. Position the UV1A, UV2 scanner within 30 inches of the flame to be monitored; the 45UV5 within 72 inches, closer if possible.
2. Select a scanner location that will remain within the ambient temperature limits of the UV Scanner. If cooling is required, use an insulating coupling (Fireeye #35-69 for UV1A, UV2 Scanners, #35-127-1 for 45UV5) to reduce conducted heat.
3. The UV1A, UV2, 45UV5 Scanners are designed to seal off the sight pipe up to 1 PSI pressure. Higher furnace pressures should be sealed off. To seal off positive furnace pressure up to 100 PSI for UV1A, UV2 Scanners, install a quartz window coupling (#60-1257) For 45UV5 Scanners, use #60-1100 coupling. Add cooling air to reduce the scanner sight pipe temperature.
4. Install the scanner on a standard NPT pipe (UV1A: 1/2", UV2: 3/8", 45UV5: 1") whose position is rigidly fixed. If the scanner mounting pipe sights through the refractory, do not extend it more than halfway through. Swivel flanges are available if desired (#60-302 for UV1A, UV2 Scanners, #60-1664-3 for 45UV5). The sight pipe must permit an unobstructed view of the pilot and/or main flame, and both pilot and main flames must completely cover the scanner field of view

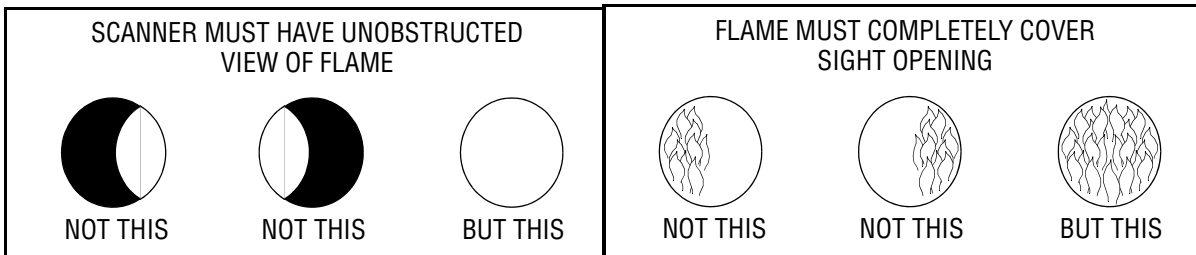

5. Smoke or unburned combustion gases absorb ultraviolet energy. On installations with negative pressure combustion chambers, a small hole drilled in the UV1A, UV2 sight pipe will assist in

- keeping the pipe clean and free from smoke. For positive pressure furnaces, provide clean air to pressurize the sight pipe, if necessary.
6. Two UV1A or UV2 Scanners may be installed on the burner if it is necessary to view two areas to obtain reliable detection of the flame. They should be wired in parallel. Only one repetitive self-checking 45UV5 Scanner may be installed on a burner.
 7. To increase scanner sensitivity with UV1A, UV2 Scanners, a quartz lens permits location of the scanner at twice the normal distance. Use 1/2" x 1 1/2" pipe nipple between UV1A Scanner and the coupling. Use 3/8" pipe nipple and a 1/2" x 3/8" bushing on UV2 installations.
 8. Request the assistance of any Fireye field office for recommendations of a proper scanner installation on a non-standard application.

FIGURE 18. TYPICAL SCANNER INSTALLATIONS

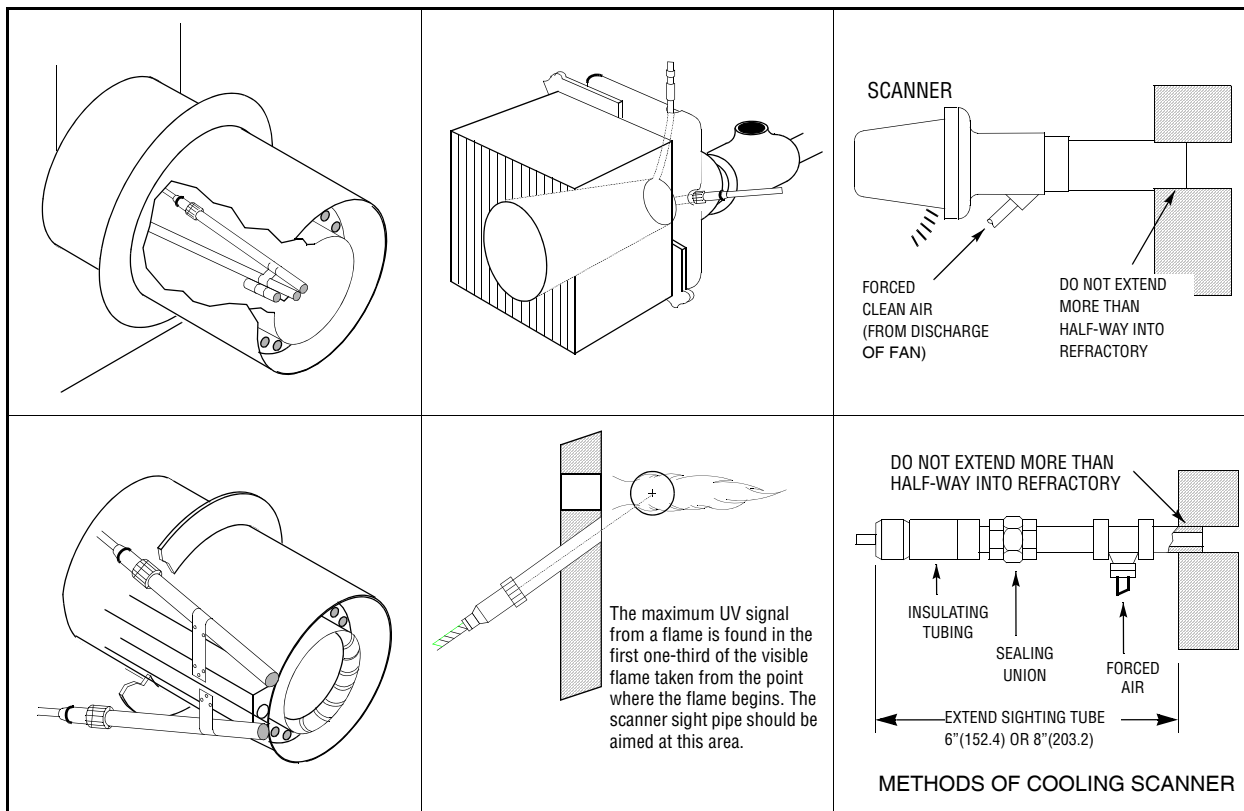

OPERATION — 45UV5 & 55UV5 SELF-CHECKING UV SCANNER

Self-checking ultraviolet scanners should be used in applications where burner firing operation is continuous or where the burner is on for long periods of time without recycling. In addition, ultraviolet self-checking systems are mandatory in some locations.

The operation of this type of system consists of maintaining the flame scanning capability at all times while also proving that the ultraviolet tube is firing properly. This is done periodically by mechanically closing off the sight of the UV tube and checking to make sure that the flame signal goes away.

A shutter assembly in the 45UV5 scanner performs this function. Figure 19 explains the process further.

If the shutter assembly in the scanner fails, the tube is faulty, or there is insufficient power to the scanner, the BurnerLogix will LOCKOUT and display the following message LOCKOUT CHECK SCANNER. The ultraviolet tube is replaceable (P/N 4-314-1).

A lockout will result if a minimum signal is detected for three consecutive shutter closed periods.

FIGURE 19.

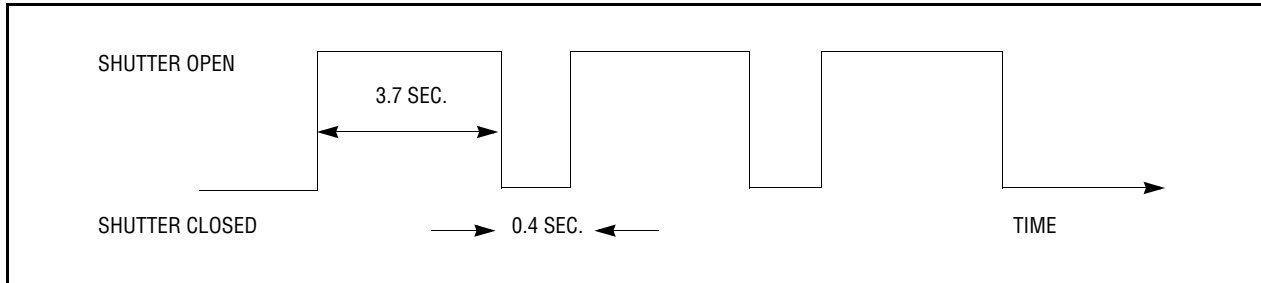

WIRING - UV SCANNERS

To connect the scanner to the control, the UV1A Scanner is supplied with 36" or 72" of flexible cable. The 45UV5 is supplied with four 72" lead wires. Install them in a suitable length of flexible armor cable and connect it to the control. A conduit connector is supplied with the scanner. Connect black wires (shutter) to terminals L1, L2; red wires (UV tube) to terminals S1, S2.

If it is necessary to extend the scanner wiring, the following instructions apply:

Scanner wires should be installed in a separate conduit. The wires from several scanners may be installed in a common conduit.

1. Selection of Wire

- a. Wiring: For extended scanner wiring up to 500 feet, and for shorter lengths to reduce signal loss, use a shielded wire (Belden 8254-RG62 coaxial cable, or equal) for each scanner wire of UV1A, UV2 and each red wire of the 45UV5. The ends of the shielding must be taped and not grounded.
- b. Asbestos insulated wire should be avoided.
- c. Multiconductor cable is not recommended without prior factory approval.

2. High voltage ignition wiring should not be installed in the same conduit with flame detector wires.

INSTALLATION—INFRARED SCANNER TYPE 48PT2

Where possible, obtain the burner manufacturer's instructions for mounting the scanner, otherwise proceed as follows:

A single scanner is used to detect both pilot and main flames. The sight pipe on which the scanner mounts must be aimed so that the scanner sights a point at the intersection of main and pilot flames.

Proper scanner positioning must assure the following:

1. Reliable pilot flame signal.
2. Reliable main flame signal.
3. A pilot flame too short or in the wrong position to ignite the main flame reliably, must not be detected.
4. Scanner must have an unobstructed view of flame being monitored.
5. Flame being monitored must completely cover the scanner field of view.
6. To avoid nuisance shutdowns, it is important to avoid sighting hot refractory and to keep scanner temperature below 140° F (60°C).
7. When the proper position has been established, drill a hole through the furnace wall and install a 4" to 8" length of threaded 1/2" black iron pipe on which to mount the 48PT2 scanner.
8. When satisfactory sighting position has been confirmed by operating tests, the sight tube should be firmly welded in place.

FIGURE 20.

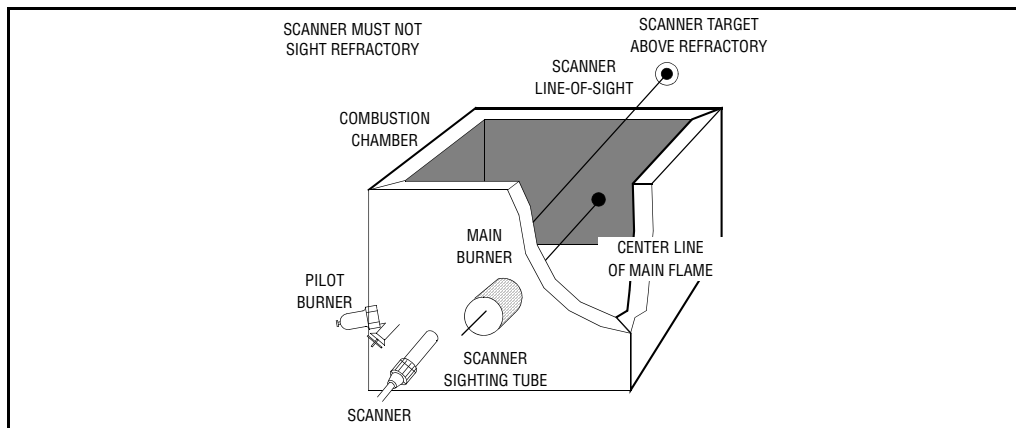

Wiring

Attach the cable supplied with the scanner to a junction box. Splice the cable wires to a pair of wires not smaller than #18. Install the complete run in a separate conduit to the control. Continuous conduit bonding between scanner and the control is mandatory! Scanner may be located up to 100 feet from control. Do not pass scanner wiring through any junction box containing other wires. Do not run other wires through scanner conduit. Asbestos insulated wire should be avoided.

OPERATION - IR LEARN (for IR models prior to version 12 only)

The BurnerLogix IR learn adapts the operation of the amplifier to the actual burner environment. 'Out of the box', the BurnerLogix IR system is shipped with its sensitivity and thresholds set to detect most firing conditions and does not require learning. The purpose of the LEARN process is to maximize reliable flame detection over a wide range of conditions. The learn process sets the optimum values for the flame on and flame off thresholds during pilot trial for ignition and the main firing period separately. The LEARN process allows the BurnerLogix system to better differentiate between real and simulated flame conditions. Simulated flame can be caused by burner throat modulation, radiation from the refractory tiles, or steam atomization. The result of this technique of flame detection assures a positive flame out response for usual or adverse conditions. Although it is not necessary to perform an IR LEARN, it is suggested this be done as part of the installation process or when the 48PT2 scanner is changed.

The type of burner and fuel will affect the amplitude and radiation characteristics of the flame. Gaseous flames tend to have low amplitude and radiation whereas oil flames have a high amplitude and radiation. On burners having the option to fire both gaseous and oil fuels, it is recommended the LEARN process be performed on the condition that has the lowest signal level. Normally this condition is gas at low fire.

The LEARN process in the BurnerLogix system is initiated through the keypad display module. The menu item is located under the PROGRAM SETUP menu and is called DO IR LEARN. Refer to the section titled '**SETTING PROGRAMMER PARAMETERS**' for information on setting operational values. Since the default value is NO, the user must modify this value to YES.

**MDFY TO CHANGE
DO IR LEARN YES**

The LEARN process is not subject to the 8 hour burn-in and therefore will always be available.

If the LEARN process is activated at STANDBY, the LEARN process will involve both pilot and main flame. If the LEARN process is activated during the main firing period (AUTO) the LEARN process will only involve the main flame learn. During this LEARN process in AUTO, the thresholds for pilot flame are not affected. It is necessary to have separate learns to adjust for the characteristics of the flame changing conditions due to changes in background conditions after a long firing period.



Once a LEARN process is activated, it cannot be undone. Also, if a LEARN cannot be completed in the subsequent burner cycle due to burner interruptions or a flame fail, the LEARN process will continue to remain active. During PTFI, the LEARN process takes place during the last 3 seconds of the pilot period and is indicated on the display:

PTFI 80
LEARNING FLAME

During AUTO the LEARN process takes place during the first 3 seconds of AUTO and is indicated on the display

HOLD 80
LEARNING FLAME

After the LEARN process is completed the flame signal displayed value is normalized to a value of 32.

AUTO 32
FLAME SIGNAL

Therefore during the next pilot trial for ignition period the expected value of flame signal should be 32.

PTFI 32
FLAME SIGNAL

Any increases or decreases in amplitude or radiation may cause the displayed value to increase or decrease. Should the displayed value continue to decrease, possibly due to changing conditions in the boiler such as a bright background causing a reduction in scanner sensitivity, it is suggested to activate a new DO IR LEARN during AUTO. Without shutting the burner off, scroll to PROGRAM SETUP and in that sub-menu, modify DO IR LEARN to YES. The LEARN function will be activated immediately. [Note: The display will continue to indicate YES even though the LEARN process is complete. Pressing the up arrow and then down arrow will indicate the updated state of DO IR LEARN.]

An abrupt change in the background radiation (brightness) may be an indication that the firing characteristics of the fuel have changed. In oil fired units this may be caused by a sudden interruption in the oil delivery. The BurnerLogix utilizes this information to make a decision to keep the burner on line or force a shut down. A lockout will happen if the background radiation (brightness) changes downward by 20% in and stays at this level for 1 FFRT. Also, if the detected flame signal average falls below 20% of the Learned On value, the burner will also be shut down.

Keeping the Scanner Cool

The Infrared Scanner (Temperature Limit 140° F) should never get too hot to grasp comfortably in the hand. Keep the scanner cool by one or more of the following methods.

1. Use 6" to 8" length of pipe between scanner and hot furnace front plate.
2. Use insulating tube (P/N 35-69) on the end of the iron pipe.
3. Force air into sighting tube. Use Fireeye Sealing Union (P/N 60-801).
4. Make sure sighting tube does not extend more than halfway into refractory wall.



INSTALLATION - 69ND1 FLAME ROD

The 69ND1 flame rod proves a gas pilot flame and/or main gas flame. It is a spark plug type unit consisting of 1/2" "NPT" mount, a KANTHAL flame rod, a glazed porcelain insulating rod holder and a spark plug connector for making electrical connections. The 69ND1 is available in 12", 18" or 24" lengths.

The flame rod may be located to monitor only the gas pilot flame or both the gas pilot and main gas flames. It is mounted on a 1/2" "NPT" coupling.

The following instructions should be observed:

1. Keep flame rod as short as possible.
2. Keep flame rod at least 1/2" from any refractory.
3. Flame rod should enter the pilot flame from the side so as to safely prove an adequate pilot flame under all draft conditions.
4. If the flame is nonluminous (air and gas mixed before burning), the electrode tip should extend at least 1/2" into the flame, but not more than halfway through.
5. If the flame is partly luminous, the electrode tip should extend only to the edge of the flame. It is not necessary to maintain uninterrupted contact with the flame.
6. It is preferable to angle the rod downward to minimize the effect of sagging and to prevent it from coming in contact with any object.
7. An adequate grounding surface for the flame must be provided. The grounding surface in actual contact with the flame must be at least 4 times greater than the area of the portion of the flame rod in contact with the flame. It is essential to adjust the flame rod and ground area ratio to provide a maximum, signal reading.

Note: Interference from the ignition spark can alter the true signal reading by adding to, or subtracting from it. This trend sometimes may be reversed by interchanging the primary wires (line voltage) to the ignition transformer. This interference can also be reduced by the addition of grounded shielding between the flame rod and ignition spark.

SYSTEM INFO SUB-MENU

The sub-menu "SYSTEM INFO" allows the user to review information pertaining to the operation of the control (e.g. average main flame signal strength, status of the high fire and low fire end switches, etc.). This information can be very helpful when setting the damper linkages on the firing rate motor. The user may also clear the internal burner history (burner hours, cycles and system hours), number of lockouts and stored lockout information.

Language choices of English, French, Spanish, Dutch, German and Swedish are available.

The MODE key is used to enter and exit the "SYSTEM INFO" sub-menu, and the NEXT and BACK keys are used to advance through the sub-menu.

FIGURE 21.

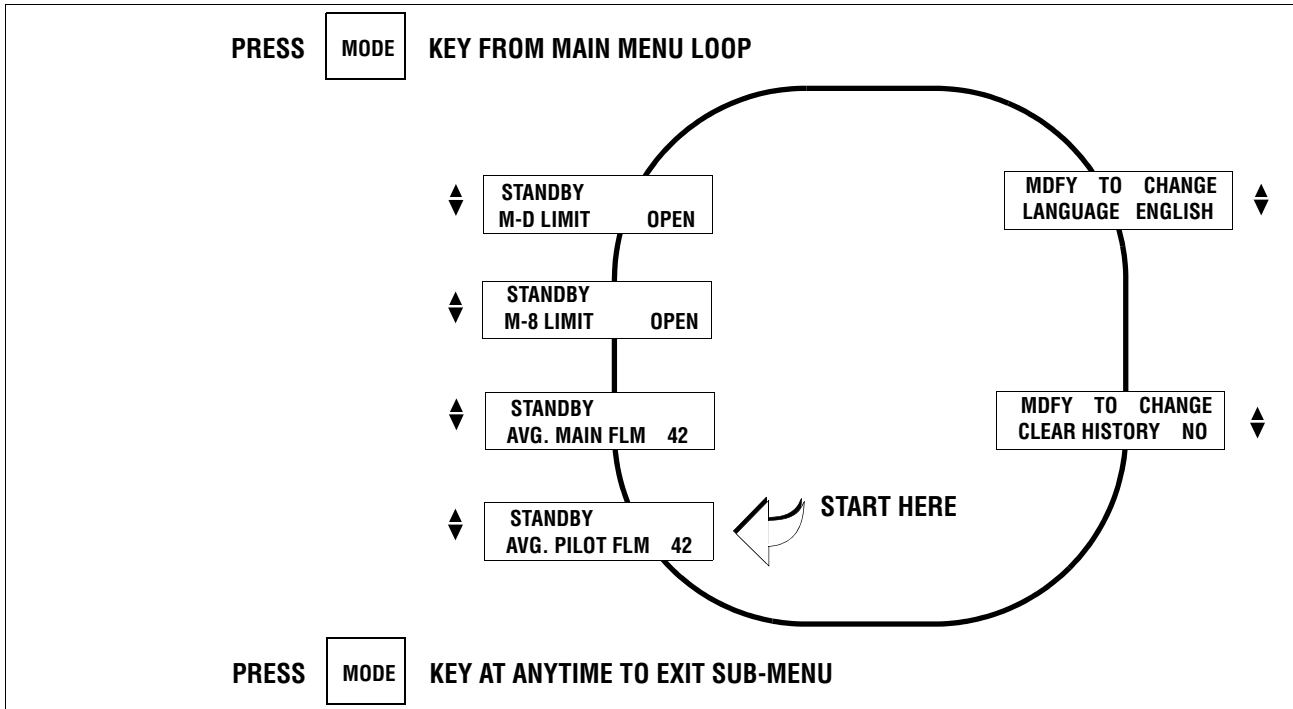

SYSTEM OPERATION

The programmer module determines the functional operation of the Burnerlogix control (e.g. purge timing, trial for ignition timings, recycle or non-recycle operation, etc.). For purposes of illustration, we will be looking at the YP100 Programmer functions and messages associated with the BLL510 display module in this bulletin. **Because the messages change depending upon which YP style programmer is being used, it is necessary to check the bulletin covering the specific programmer for exact details.** Refer to the suggestions shown in this bulletin before proceeding to power the Fireeye ZB110 BurnerLogix system. Items such as scanner installation, short circuit tests and safety information should be carefully reviewed.



YP100 Operating Sequence

Terminal								PTFI	MTFI	AUTO			Post Purge	STANDBY
3	Operating control and pcv < cut in													
M														Cycle complete
	Air flow (terminal P) must close within 10 seconds of HFS (M-8) closing													
P														Valve closes in one second
13 (POC)	Proof of valve closure													
	Don't care state													
	PTFI/MTFI times keypad selectable													
6 (PV)													15 s	
													10 s	
5 (IGN/PV)													10 s	
W (IGN)													5s	
7 (MV)														
	Programmable time begins (30 sec minimum)													
8 (HFS)														
													LFS must be closed	Don't care state
D (LFS)	30 s LFS													

Start-Up (Normal Cycle)

Note: For direct spark ignited oil burners, substitute the words Main-Oil Valve for Pilot Valve.

1. Constant 120 VAC should be available to the LI-L2 terminals only on the wiring base.
2. The operating control circuits (LI-3) will close, signaling the burner to start its firing sequence. Terminal 13, fuel valve end switch must be closed.
3. The burner/blower motor (terminal M) circuit is energized. The running interlock (limit) circuit (3-P) will close (e.g. all limits, interlocks, etc. are proven).
4. See Figure 2 for sensor wiring.
5. When the firing rate motor reaches its open damper position, the Hi Purge switch closes (M-8) and the prepurge interval of 30* seconds is initiated. Assuming countdown method, the BLV512 will display:

PREPRG 00:25
HIGH FIRE PURGE

If the M-8 circuit does not close, the program will hold in this position for ten minutes waiting for it to close. If it does not, the control will lockout. If the M-8 circuit is closed at the start of a cycle, the top line of a display will switch to PURGE 20 seconds.

PURGE 00:19
HIGH FIRE PURGE



If the M-8 circuit is not closed at the beginning of a cycle, the top line of a display will switch to PURGE 10 seconds.

**PURGE 00:10
HIGH FIRE PURGE**

- When the prepurge is completed, the firing rate motor is driven toward the low purge damper position (10-12 circuit made). The BLV512 will display:

**PURGE 00:24
LOW FIRE PURGE**

- Following the minimum 30 second delay (to permit the firing rate motor to get to the low fire position), the control will wait for the low fire switch (M-D) to close. When it closes, the trial for ignition sequence will start. If after ten minutes, the M-D circuit is not closed, the control will lockout unless selected to wait indefinitely.
- The trial for ignition period begins with Terminals 5, 6 and W being energized simultaneously. This is known as PTFI (Pilot Trial for Ignition). The BLV512 will display:

**PTFI 00:02
IGNITION TIMING**

Unless otherwise selected this period is ten seconds in duration. Terminal W will de-energize after 5 seconds. Refer to PTFI*MTFI TIMINGS to determine times selected or timings appropriate for the application. The test meter jacks on the ZB110 will provide an indication of the flame signal strength. The flame signal readout is also available on the alpha-numeric display.

	TEST JACKS	DISPLAY
MINIMUM ACCEPTABLE	6mA	6-16
NORMAL	7.5 -20mA	20-80

**PTFI 20
FLAME SIGNAL**

- With flame proven at the end of PTFI, the main flame trial for ignition (MTFI) period begins. Terminal 7 is energized. The BLV512 will display:

**MTFI 35
FLAME SIGNAL**

Terminal 5 is de-energized 10 seconds later and Terminal 6 is de-energized after another 5 seconds.

- The firing rate motor is now sent to the automatic modulation position (10-11 circuit made) and is under the command of the proportional controller. The BLV512 will display:

**AUTO 40
FLAME SIGNAL**



Normal Shutdown

1. When the operating control circuit (L1-3) opens, the main fuel valve is de-energized. The firing rate motor is driven to the low purge position (10-12 circuit made).
2. Following a 15 second post purge, the burner/blower motor is de-energized.

**POST PURGE 0:05
CYCLE COMPLETE**

3. The burner is now off and the BLV512 will display

**STANDBY
L1-3 OPEN**

SUGGESTED WIRING DIAGRAM FOR YP138 PROGRAMMER

FIGURE 22.

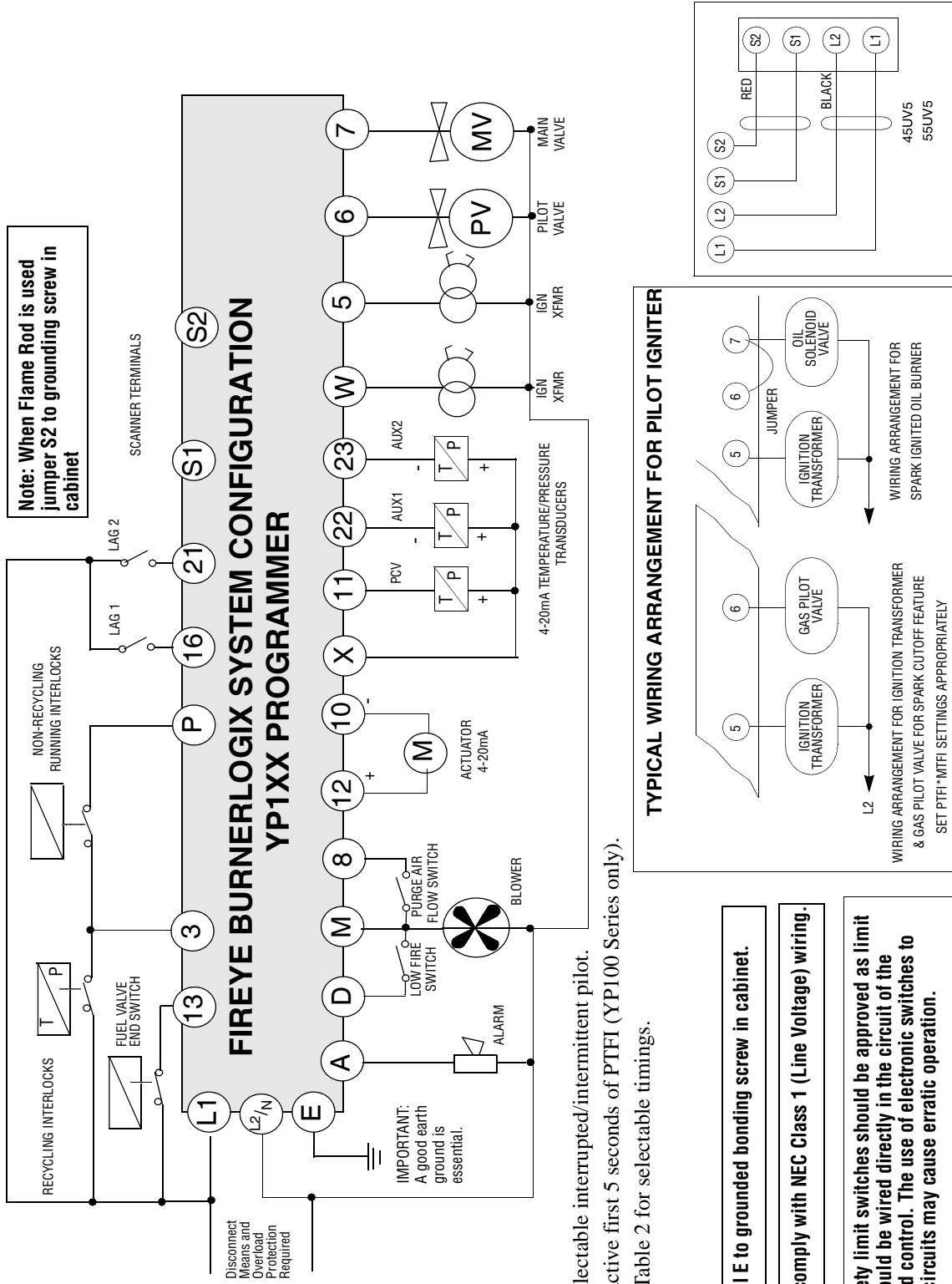

1. Terminal 6 selectable interrupted/intermittent pilot.
2. Terminal W active first 5 seconds of PTFI (YP100 Series only).
3. See chart on Table 2 for selectable timings.

Connect terminal E to grounded bonding screw in cabinet.

All wiring must comply with NEC Class 1 (Line Voltage) wiring.

Caution: All safety limit switches should be approved as limit controls and should be wired directly in the circuit of the Flame Safeguard control. The use of electronic switches to close interlock circuits may cause erratic operation.



LOCKOUTS

When a safety shutdown occurs, the control will indicate through the LED's the reason for the lockout and if equipped will display a lockout message and when in the cycle the lockout occurred. The alarm circuit (Terminal "A") will be energized. The non-volatile memory will remember the status of the control even if a power failure occurs. By momentarily depressing and releasing the reset button on the control or the display keypad, the control can be reset. The button must be held down for one second and then released. Very little force is required to do this. Do not press hard.

SAFETY SHUTDOWN

1. If the running interlock circuit (3-P) does not close, the control will lockout and the blower motor will be de-energized.

PROVING 3-P CLOSED

On cycle start the BurnerLogix proves the 3-P running interlock circuit closed in the following manner:

1. At cycle start (L1-3 closes), if the M-8 damper switch is closed, the pre-purge period begins and the BurnerLogix will wait up to 20 seconds for the 3-P circuit to close.
 2. At cycle start (L1-3 closes), if the M-8 damper switch is open, the BurnerLogix will wait up to 10 seconds for the 3-P circuit to close after the M-8 circuit closes. Pre-purge timing begins after the M-8 closes circuit closes.
2. If the fuel valve end switch or proof of closure switch connected to Terminal 13 opens during standby or purge, the control will lockout.
 3. If the running interlock circuit (3-P) opens during a start-up or firing period, all fuel valves will be de-energized and the control will lockout.
 4. If the proven high fire circuit (M-8) has not closed after a ten (10) minute "Hold" period at the start of prepurge, the control will lockout.
 5. If the low fire start circuit (M-D) has not closed after a ten (10) minute "Hold" period at the end of prepurge, the control will lockout.
 6. a.) If PROVE 3-P OPEN is selected as YES, and the 3-P circuit is closed at the start of the operating cycle, the control will hold for thirty (30) seconds waiting for the 3-P circuit to open. If, after thirty (30) seconds, the 3-P circuit does not open, the control will lockout.
b.) If PROVE M-8 OPEN is selected as YES, and the M-8 circuit is closed at the start of a cycle, the control will hold for thirty (30) seconds for it to open. If, after thirty (30) seconds, the M-8 is still closed, the control will lockout.
c.) If PROVE M-D OPEN is selected as YES, and the M-D switch is closed at the end the high fire purge cycle, the control will hold for thirty (30) seconds for it to open. If, after thirty (30) seconds, the M-D is still closed, the control will lockout.
d.) If PROVE M-D TFI is selected as YES, the low fire start switch located between terminals M-D must be closed during PTFI and MTFI.
 7. If pilot flame is not detected after the pilot trial for ignition period, the pilot valve and ignition transformer will be de-energized and the control will lockout on safety.
 8. If main flame is not detected during the main flame trial for ignition period for one FFRT, all fuel valves will be de-energized and the control will lockout on safety.
 9. If the main flame fails during a firing cycle, all fuel valves will be de-energized within 1 FFRT and the control will lockout on safety.
 10. If flame is detected when the operating control (L1-3) is open, the control will wait sixty (60) seconds and then lockout if flame is still present. If the operating control closes and flame is detected during purge, the control will drop back to Standby position and de-energize the blower motor (Term M). If the flame signal goes away within sixty (60) seconds, the control will proceed with a normal start-up. If flame signal is still present after sixty (60) seconds, the control will lockout.
 11. If the fuel valve end switch connected to Terminal 13 is not closed after 5 seconds into post purge, the control will lockout on safety.



DIAGNOSTIC MESSAGES

MESSAGE	POSSIBLE CAUSE	SOLUTION
CHECK PROGRAMMER	No programmer module plugged into ZB chassis/amplifier module	Remove power, insert programmer, press reset to clear fault
	Defective programmer module	Remove power, replace programmer module
CHECK CHASSIS	Relay feedback error caused by bad wiring	Check all wiring, Re-inspect routing of all wires
	Programmer module inserted while power is applied	Cycle power, reset control
	Defective opto-coupler on the ZB chassis/amplifier	Replace ZB module
CHECK WIRING	Voltage is detected on terminals at improper time	Check system wiring. Measure voltages on input/output terminals
CHECK SCANNER	Flame signal detected during shutter close time in 45UV5 or 55UV5 scanner	Check power on shutter terminals and/or replace shutter in scanner
	Runaway UV tube	Replace UV tube, part number 4-314-1
CHECK EXPANSION MODULE	Internal diagnostics within expansion module has detected a problem and ceased communications with BurnerLogix control for 3 minutes.	Check that ED580 cable from expansion module to BurnerLogix is plugged in or not damaged, check routing of cable within burner cabinet or check L1-L2 connections to expansion module. Reset control and check STATUS LED on expansion module. Replace YZ300 or YZ320 expansion module or ZB110 chassis/amplifier module.
	Defective or unplugged ED580 cable	Assure cable is fully inserted in both BurnerLogix control and Expansion module. Check for damage to cable or connectors.
INVALID YP TYPE	Incorrect YP programmer type inserted in BurnerLogix Z control	Only programmer types YP1xx are compatible with BurnerLogix Z model
WAITING FOR DATA	Communications to/from display	Indicates the display is not communicating properly with chassis. Check that the YP programmer is properly inserted. Check that the cable is not defective and is properly inserted into the connectors. In rare instances due to ongoing enhancements to the BurnerLogix family, the display and chassis may not be compatible. Check the date code and engineering code of both sets.

RESETTING THE CONTROL

The BurnerLogix systems contain three methods of reset, by push-button located on the ZB chassis/amplifier module, by keypad push-button located on the optional keypad/display module, and by normally open push-button connected from line voltage (L1) to LAG2 input (terminal 21). LAG2 is a line voltage isolated input. Depressing and releasing the reset button is required. See ALTERNATE USES FOR LAG2.

Notes:

1. Manual Reset is required following any safety shutdown.
2. Depressing and releasing the reset button during a cycle will cause the control to shut the burner down and recycle.
3. The YP113 programmer limits the amount of reset attempts to 5 tries. This internal counter gets reset to 0 when the control reaches the AUTO state and on every application of power.

LOCKOUT CODES













During an alarm condition, the Alarm LED  is made to flash at approximately a twice per second rate. The remaining LED's are illuminated as a coded sequence identifying the reason for the lockout. This remains true if power is removed and then restored in a locked out condition.

Table 5:

LED DISPLAY READOUT ● = ON	A	B	C	D	E	F	
LOCKOUT MESSAGE	FAN	OPEN DAMPER	CLOSE DAMPER	AUTO	IGN	FLAME	
							
T13 FUEL VALVE END SWITCH OPEN					●	●	
M-D LOW FIRE START OPEN				●		●	
M-D LOW FIRE START OPEN - PTFI	●			●		●	
M-D LOW FIRE START OPEN - MTFI	●	●		●		●	
M-D CLOSED			●		●		
M-8 CLOSED			●			●	
M-8 HIGH PURGE CIRCUIT OPEN				●			
FALSE FLAME-STANDBY				●	●		
FLAME FAIL PTFI	●			●	●	●	
FLAME FAIL - MTFI	●	●		●	●	●	
FLAME FAIL AUTO				●	●	●	
3-P RUN INTLK OPEN - PREPURGE	●		●			●	
3-P RUN INTLK OPEN - PURGE	●		●		●		
3-P RUN INTLK OPEN-PTFI	●		●				
3-P RUN INTLK OPEN-MTFI	●	●	●				
3-P RUN INTLK CLOSED-STANDBY						●	
3-P RUN INTLK OPEN-AUTO			●				
FUEL VALVE STATE CHANGE					●		
CHECK FUSE			●	●	●		
CHECK WIRING			●	●		●	
CHECK SCANNER			●		●	●	
CHECK PROGRAMMER or INVALID YP			●	●			
CHECK CHASSIS		●					
CHECK EXPANSION MODULE			●	●	●	●	



LED DISPLAY READOUT ● = ON	A	B	C	D	E	F	
LOCKOUT MESSAGE	FAN	OPEN DAMPER	CLOSE DAMPER	AUTO	IGN	FLAME	
							
PCV UNDER RNG		●				●	
PCV OVER RNG		●			●		
PCV HIGH LIMIT		●			●	●	
AUX1 UNDER RNG		●		●			
AUX1 OVER RNG		●		●		●	
AUX2 UNDER RNG		●		●	●		
AUX2 OVER RNG		●		●	●	●	
AUX1 HIGH LIMIT		●	●				
AUX2 HIGH LIMIT		●	●			●	

LOCKOUT HISTORY SUB-MENU

The sub-menu "LOCKOUT HISTORY" will display the last ten (10) lockouts, along with the burner cycle and burner hour when the lockout occurred. When the MODE key is pressed, the screen will display the most recent lockout condition and the number of that lockout (e.g. LO #10 represents the 10th lockout of that control). The NEXT key will display the Burner Hour, followed by the Burner Cycle when the lockout occurred. The NEXT key will advance to the next lockout, and repeat the sequence listed above. The BACK key can be used to scroll back up through the sub-menu items. The MODE key will exit the sub-menu.

FIGURE 23.

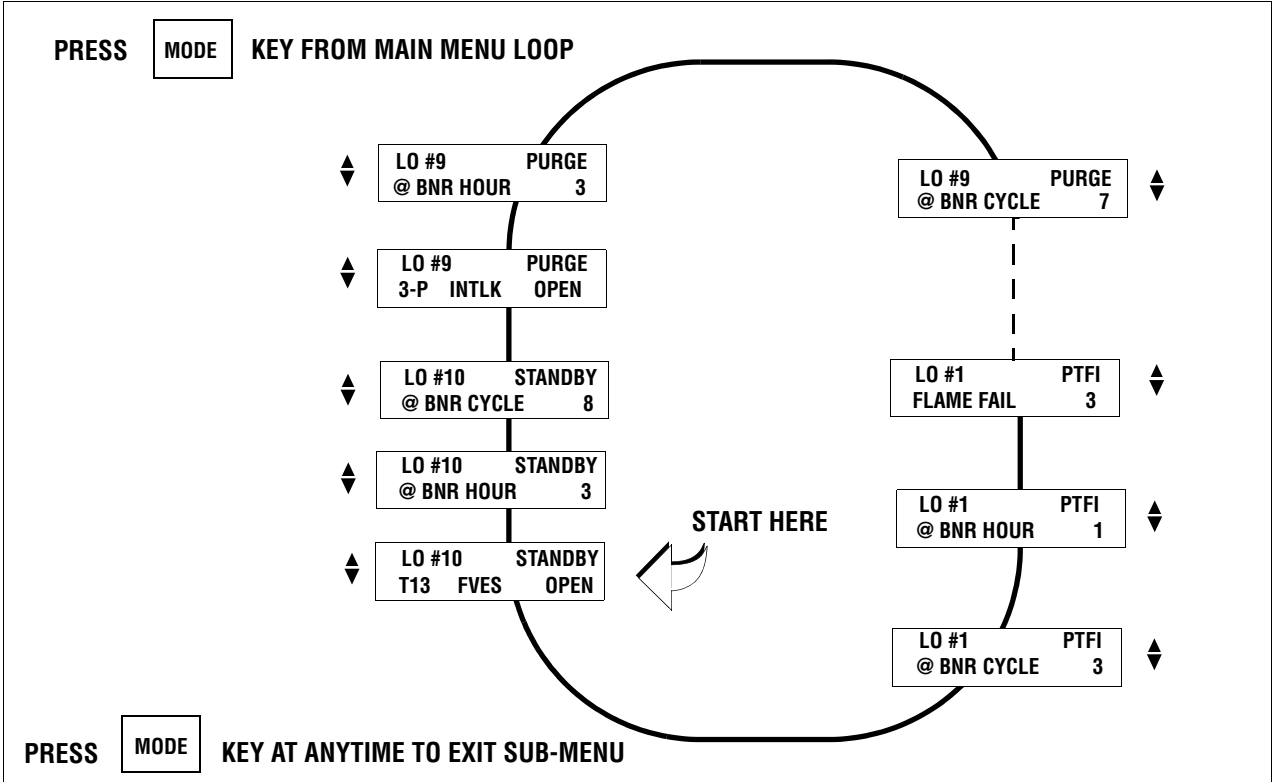

COMMUNICATIONS

The protocol to be used is Modbus RTU. This is implemented by the master (PC, PLC, etc.) issuing a poll to the slave (BurnerLogix) and the slave responding with the appropriate message.

MESSAGE FORMAT

DST	FNC	ADR HI	ADR LO	DAT HI	DAT LO	CRC LO	CRC HI
-----	-----	-----------	-----------	-----------	-----------	-----------	-----------

DST refers to the logical address of the slave.

FNC is the function being requested. FNC 03 is a read request and FNC 06 is a write request.

ADR is the message number or register number of the data being requested.

For the BurnerLogix, all registers are mapped as HOLDING REGISTERS. Register addresses begin at 40001 but is interpreted as address 00.

DAT is the number of words being requested. A word is an integer consisting of 2 bytes.

The normal response from a slave is as follows:

DST	FNC	DBC	DATA.... Hi/Lo Format	CRC LO	CRC HI
-----	-----	-----	--------------------------	-----------	-----------

DBC is the data byte count being returned. It must be two times the DAT number from the poll request.

DATA is the data returned and is always a series of 2 byte integers. If 4 words were requested then DBC would be 8 and there would be 8 data bytes or 4 data words containing the requested data.

The format of the data is N,8,1 meaning no parity, and 1 stop bit. Baud rate is selectable through the keypad / display. As shipped the baud rate is 9600.

Communication to the BurnerLogix control is made through either of the RJ-12 jacks located on the underside of the control (note figure on right). The jacks are internally wired in parallel to ease multi-dropping of BurnerLogix controls. For each of the RJ-12 connections, the outside contacts are connected together and are designated as "A" or "+" while the inside contacts are connected together and are designated as "B" or "-". Fireeye supplies the ED512 cables in various lengths with RJ-12 plugs on each end. Refer to bulletin E-8002 for additional information.

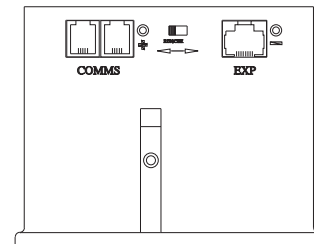

Below is a table of currently available messages provided by the BurnerLogix programmers, followed by a description where necessary.



MODBUS MESSAGE TABLE

Table 6:

HOLDING REGISTER	MESSAGE ADDRESS	WORD REQUESTED	WORD RESPONSE	VALUE
40001	00	1	STATUS	83 (053H) = RUN; 202 (0CAH) = LOCKOUT
40002	01	1	MSGN	Current message being displayed (see Table 9)
40003	02	1	GSTAT	Defines Timer Type
40004	03	1	TIMER	Time in seconds
40005	04	1	FLAME	Flame Signal
40006	05	1	LOGSTAT	Current logic module, PURGE, PTFI, AUTO (see Table 8)
40007	06	1	INPUTS	Input limits state
40008	07	1	OUTPUTS	Output relays state
40009	08	2	SYSMINS	System on minutes
40011	10	2	BNRMINS	Burner on minutes
40013	12	2	CYCLES	Completed Burner Cycles
40015	14	1	LOCKOUT COUNT	Stored Lockout Count
40016	15	6	LOCKOUT HISTORY	Beginning of Last 10 Lockouts
			Most Recent Lockout Data	Returns complete lockout description of stored lockout history. Includes lockout message (1), lockout module (1), @ burner hours (2), and @ burner cycles (2)s
40022	21	6	2nd Most Recent Lockout Data	
40028	27	6	3rd Most Recent Lockout Data	
40034	33	6	4th Most Recent Lockout Data	
40040	39	6	5th Most Recent Lockout Data	
40046	45	6	6th Most Recent Lockout Data	
40052	51	6	7th Most Recent Lockout Data	
40058	57	6	8th Most Recent Lockout Data	
40064	63	6	9th Most Recent Lockout Data	
40070	69	6	10th Most Recent Lockout Data	
40076	75	4		
•	•			
•	•			
40079	78			
40080	79	11	N/A	Reserved for Fireye use
•	•			
•	•			
40090	89			
INTERLOCK ANNUNCIATOR				
40901	900	1 - 3	YZ300 Interlock Annunciator registers (see Table 7)	Returns lower, middle and upper interlock annunciator (YZ300) registers.
40902	901	1 - 2		Returns middle and upper interlock annunciator (YZ300) registers.
40903	902	1		Returns upper interlock annunciator (YZ300) register.



HOLDING REGISTER	MESSAGE ADDRESS	WORD REQUESTED	WORD RESPONSE	VALUE
BOILER OPERATING PARAMETERS				
40100	99	1	Calibration Constant (used to normalize A/D readings)	READ Only Values
40101	100	1	Primary sensor Raw A/D reading	
40102	101	1	AUX 1 sensor Raw A/D reading	
40103	102	1	AUX 2 sensor Raw A/D reading	
40104	103	1	LEAD / LAG status	
40105	104	1	Current Modulation Rate	
40106	105	1	LAGx START DELAY	
40107	106	1	Current Control Variable	
40110	109	1	Primary Sensor Use	<p>Except as noted, all boiler parameters are readable, FNC 03 and writeable, FNC 06. Only word writes are provided.</p> <p>Consult factory or refer to www.fireeye.com for acceptable minimum and maximum values</p>
40111	110	1	Primary Sensor Type	
40112	111	1	Primary Sensor Set Point	
40113	112	1	Primary Sensor Cut In	
40114	113	1	Primary Sensor Cut Out	
40115	114	1	Primary Sensor Mod Range	
40116	115	1	Primary Sensor Marginal Alarm	
40117	116	1	Primary Sensor Limit Alarm	
40120	119	1	AUX 1 Sensor Use	
40121	120	1	AUX 1 Sensor Type	
40122	121	1	AUX 1 Sensor Set Point	
40123	122	1	AUX 1 Sensor Cut In	
40124	123	1	AUX 1 Sensor Cut Out	
40125	124	1	AUX 1 Sensor Mod Range	
40126	125	1	AUX 1 Sensor Marginal Alarm	
40127	126	1	AUX 1 Sensor Limit Alarm	
40130	129	1	AUX 2 Sensor Use	
40131	130	1	AUX 2 Sensor Type	
40132	131	1	AUX 2 Sensor Set Point	
40133	132	1	AUX 2 Sensor Cut In	
40134	133	1	AUX 2 Sensor Cut Out	
40135	134	1	AUX 2 Sensor Mod Range	
40136	135	1	AUX 2 Sensor Marginal Alarm	
40137	136	1	AUX 2 Sensor Limit Alarm	
40140	139	1	LAG 1 Lag Mode	
40141	140	1	LAG 1 Start Delay	
40142	141	1	LAG 1 Lead to Lag Delay	
40143	142	1	LAG 1 Sensor Set Point	
40144	143	1	LAG 1 Sensor Cut In	
40145	144	1	LAG 1 Sensor Cut Out	
40146	145	1	LAG 1 Sensor Mode Range	
40147	146	1	LAG 1 Mod Max	



HOLDING REGISTER	MESSAGE ADDRESS	WORD REQUESTED	WORD RESPONSE	VALUE
40150	149	1	LAG 2 Lag Mode	<p>Except as noted, all boiler parameters are readable, FNC 03 and writeable, FNC 06. Only word writes are provided.</p> <p>Consult factory or refer to www.fireye.com for acceptable minimum and maximum values</p>
40151	150	1	LAG 2 Start Delay	
40152	151	1	LAG 2 Lead to Lag Delay	
40153	152	1	LAG 2 Sensor Set Point	
40154	153	1	LAG 2 Sensor Cut In	
40155	154	1	LAG 2 Sensor Cut Out	
40156	155	1	LAG 2 Sensor Mode Range	
40157	156	1	LAG 2 Mod Max	
40160	159	1	Thermal Shock Method	
40161	160	1	Thermal Shock Start Point	
40162	161	1	Thermal Shock Exit Point	
40163	162	1	Thermal Shock Low Fire Minimum	
40164	163	1	Thermal Shock Override Time	
40170	169	1	Modulation Mode	
40171	170	1	Integral Gain	
40172	171	1	Derivative Gain	
40173	172	1	Modulation Maximum Position	
40174	173	1	Units of Measurement	
40175	174	1	Manual Mod Position	
40176	175	1	PassWord Level 1	
40177	176	1	PassWord Level 2	

Interpreting Z Model Modbus Values

The calibration constant is factory set to achieve the proper reading at 4mA and 20 mA. It is based on the actual hardware in the product and the A/D reference voltage in the micro controller at the time of manufacture. It has a range of 819 to 860 counts and is accessible from register 99 (40100). This should be the first value read in and used for all pressure and temperature calculations.

The calibration constant is used to convert the actual sensor reading to meaningful pressure or temperature values. The pressure sensors are all 0 psig at the 4 mA and below reading. For the two temperature sensors, 32-350 and 32-752, the maximum range of each is 318 and 720 degrees respectively.

If the calibration constant represents 20 mA input then 1/5 of that represents 4 mA input or 0.2 times the calibration constant.

To convert a pressure or temperature reading to actual units, use the following:

$(([\text{Reading} / \text{calibration constant}] - 0.2) / 0.8) * \text{Sensor Range} + \text{Sensor Offset}$ where Reading is the value returned from modbus register 4101, 40102 or 40103.

SENSOR TYPE	SENSOR RANGE	SENSOR OFFSET
TS350-2, -4, -8	318	32
TS352-2, -4, -8	720	32
BLPS-15	15	0
BLPS-30	30	0
BLPS-200	200	0
BLPS-300	300	0



It is suggested that polling intervals not be less than 200 mSec per request. Requesting data such as burner minutes, system minutes and burner cycles should be kept at a minimum due to the amount of processing time required to gather that data.

The MSGN being transmitted is a numerical value and must be interpreted by the communicating device, which actually is an advantage since this can be made to be whatever message text the end user wants. In other words, it allows for programming custom messages without actually changing the message in the programmer. Refer to Table 9, for message information.

The BurnerLogix stores its burner on time (7 powered) and system on time (L1 powered) in minutes. For display purposes, the programmer converts this to hours. The information being supplied by Modbus will be the actual time in minutes and it is up to the communicating device to do the conversion. Since the maximum value stored in the BurnerLogix is 9,999,999 minutes, the maximum value in hex therefore is 98967FH and comprises two data words. The maximum cycle count is 999,999 decimal or F423FH, still two data words.

*To convert, multiply high word by 10000H (65536), add to this high byte of low word multiplied by 100H (256) and add to this the low byte of low word. Example: (98H*10000H) + (96H*100H) + 7FH = 98967FH = 9,999,999 minutes.*

As an example, the System on Minutes data is transmitted from the BurnerLogix to the interface as high word / low word as shown below. The same applies to Burner on Minutes and Burner Cycles.

ADDRESS 8/11/13		ADDRESS 9/12/14	
HIGH WORD		LOW WORD	
HIGH BYTE	LOW BYTE	HIGH BYTE	LOW BYTE
0	98H	96H	7FH

All values are represented in a HEX or base 16 format.

GSTAT determines the type of value TIMER represents. TIMER can be a running timer such as is used in purge, a flame signal or meaningless. Only the lower nibble of GSTAT has any value. If this value is 0 then the TIMER value has no meaning. The value in TIMER is a background minute timer in the BurnerLogix and should be ignored. If GSTAT is between 4 and 7, the TIMER represents the current value flame signal. If GSTAT is a 1, 2, or 3 then TIMER represents a running timer value.

The format of the data is 8 data bits, no parity and 1 stop bit. Due to the RS485 format, the communication format is considered half-duplex. That is, only one user is permitted on the communication lines at a time.

The information contained in INPUTS and OUTPUTS represents the status of the interlocks and output relays respectively. For the INPUTS, a 1 in the interlock position defines the interlock as being on or active where a 1 in any bit position in the OUTPUT register signifies the relay as being energized.

INPUTS (40007)

Bit 15							Bit 8
AC Line	Term D	Term 8	Term 13	Term 21	Term 22	Term 23	Term 6
Ref	Low Fire Start	High Fire Intlck	FVES POC	LAG2	N/A	N/A	LAG1

Bit 7							Bit 0
Term P	Term 3	Term M	Term 5	Term 6	Term W	Term 7	KS
Run Interlock	Op Cntrl	Blower	Ignition	Pilot Valve	Delayed Valve	Main Valve	Safety Relay

A '1' in the opto-coupler position indicates the opto-coupler is on or interlock closed.



OUTPUTS (40008)

Bit 15				Bit 11			Bit 8
				Term A	Term 11	Term X	Term 12
				Alarm	Auto	High Fire	Low Fire

Bit 7				Bit 3			Bit 0
	IS	Term W	Term 7	Term M	Term 6	Term 5	
	Internal Safety	Delayed Valve	Main Valve	Blower	Pilot Valve	Ignition	

Note: A "1" in any bit position indicates the output or terminal is on or active.

Table 7:

YZ300 LOWER (40901) – REFER TO BULLETIN YZEM-3001

Bit 7							Bit 0
Term 47	Term 46	Term 44*	Term 43	Term 3	Term 42	Term 41	Term 40
Low Oil Temp	High Oil Temp	Low Water	High Water	Aux #3	Aux #2	Aux #1	Op Control

* Terminals 44 and 45 are internally connected

YZ300 MIDDLE (40902) – REFER TO BULLETIN YZEM-3001

Bit 7							Bit 0
Term 57	Term 56	Term 55	Term 54*	Term 52	Term 51	Term 49*	Term 48
Aux #4	High Temp	High Pressure	Aux Gas	High Gas Pressure	Low Gas Pressure	Low Atomizing Media	Low Oil Pressure

* Terminals 49 and 50 are internally connected

* Terminals 53 and 54 are internally connected

YZ300 UPPER (40903) – REFER TO BULLETIN YZEM-3001

Bit 7							Bit 0
				Term P	Term 60	Term 59	Term 58
Unused	Unused	Unused	Unused	Air Flow	Aux #7	Aux #6	Aux #5

* Unused Bits 4-7 will always return 0

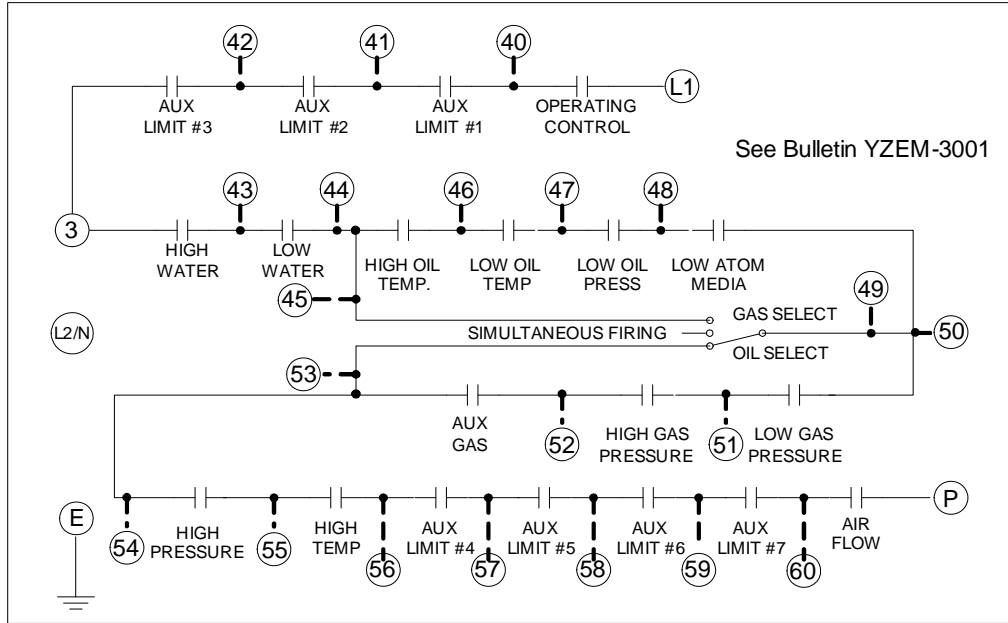

Default wiring for YZ300 Interlock Annunciator

EXPLANATION OF LOGSTAT

LOGSTAT is an indication of what logic module the control is currently operating in during its cycle and is used for diagnostic purposes only. If a lockout occurs the current value of LOGSTAT is stored as part of the lockout information. The message displayed corresponds to the current logic module.

Table 8:

LOGIC DISPATCHER			
VALUE		MODULE	FUNCTION
DEC	HEX		
1	01H	STANDBY	Idle state
2	02H	BLOWER ON	1/2 second period after operating control closes when blower motor is energized
3	03H	PURGE	Open Damper Purge or waiting for air flow and/or high fire switch to close
4	04H	PURGE	Low Fire Purge
5	05H	PTFI	Pilot Trial for Ignition
6	06H	PTFI	Pilot Trial for Ignition for YP3XX programmers
7	07H	PTFI	If PTFI is greater than 5 seconds and early spark termination is not needed
8	08H	PTFI	If PTFI is greater than 5 seconds and early spark termination is needed
9	09H	PILOT	Pilot Hold, YP138 only
10	0AH	MTFI	Main Trial for Ignition
11	0BH	MTFI	Main Trial for Ignition with terminal 5 de-energized
12	0CH	AUTO	Delayed valve on
13	0DH	AUTO	AUTO
14	0EH	AUTO	On YP138 programmer, hold for 20 seconds with terminals 6 and 7 energized
15	0FH	AUTO	On YP138 programmer, when terminal 21 first energized, wait for M-D to close
16	10H	POSTPURGE	Post Purge
17	11H	POSTPURGE	Post Purge period if flame fail lockout
18	12H	POSTPURGE	Idle state if unit is in lockout
19	13H	PRE PURGE	

Logstat represents the current software module the BurnerLogix is currently executing.



The BurnerLogix outputs the current displayed message as well as the historical lockout messages as numbers. The table below correlates the message number with the actual displayed text message.

Table 9:

DEC	HEX	STATE	BURNERLOGIX MESSAGES
1	1	L	M-D LOW LIMIT OPEN - AUTO
2	2	H	HOLD FALSE FLAME- STANDBY
3	3	R	LOW FIRE PURGE
4	4	H	HOLD M-8 LIMIT OPEN - PURGE
5	5	H	See Interlock Annunciation Message Table
6	6	H	M-D LOW LIMIT - AUTO
7	7	L	LOCKOUT FLAME FAIL - PTFI
8	8	R	T16 INPUT
9	9	H	HOLD M-D LIMIT OPEN
10	A	R	IGNITION TIMING - PTFI
11	B	C	CHECK FLAME SIGNAL - MTFI
12	C	R	FLAME SIGNAL - AUTO
13	D	R	CYCLE COMPLETE - POST PURGE
14	E	R	L1-3 OPEN
91	E	R	L1-3 CLOSED (Z MODEL ONLY)
15	F	R	T21 INPUT
16	10	L	LOCKOUT M-D LIMIT OPEN - PTFI
17	11	L	LOCKOUT M-8 LIMIT OPEN
18	12	L	LOCKOUT M-D LIMIT OPEN
19	13	L	LOCKOUT FLAME FAIL - MTFI
20	14	L	LOCKOUT FALSE FLAME
21	15	L	LOCKOUT 3-P INTLK OPEN (PURGE)
22	16	L	LOCKOUT 3-P INTLK CLOSED
23	17	H	HOLD 3-P INTLK CLOSED - STANDBY
24	18	H	HIGH FIRE PURGE
25	19	L	LOCKOUT M-D LIMIT OPEN - MTFI
26	1A	L	LOCKOUT 3-P INTLK OPEN -AUTO
27	1B	L	LOCKOUT 3-P INTLK OPEN - MTFI
28	1C	L	LOCKOUT 3-P INTLK OPEN - PTFI
29	1D	L	LOCKOUT T13 FVES OPEN - STANDBY
30	1E	L	LOCKOUT 3-P INTLK OPEN - PREPURGE
31	1F	C	CHECK FLAME SIGNAL - PTFI
32	20	C	CHECK M-8 HI LIMIT (HI FIRE PURGE)
33	21	C	CHECK M-D LOW LIMIT (LO FIRE START)
34	22	R	FLAME SIGNAL - PTFI
35	23	C	CHECK LOW FIRE SIGNAL - AUTO
36	24	R	FLAME SIGNAL - MTFI
37	25	L	LOCKOUT FLAME FAIL (AUTO)
38	26	H	HOLD 3-P INTLK OPEN - PREPURGE
39	27	L	LOCKOUT FUEL VALVE STATE CHANGE



DEC	HEX	STATE	BURNERLOGIX MESSAGES
SYSTEM DIAGNOSTIC MESSAGES			
54	36	L	LOCKOUT CHECK CHASSIS
55	37	L	LOCKOUT CHECK PROGRAMMER
56	38	L	See Interlock Annunciation Message Table
57	39	L	LOCKOUT CHECK EXPANSION MODULE
58	3A	L	LOCKOUT CHECK WIRING
59	3B	L	LOCKOUT CHECK FUSE
76	4C	L	LOCKOUT CHECK SCANNER
104	68	R	LEARNING FLAME (PTFI and AUTO)
PURGE INTERLOCK RELATED MESSAGES			
77	4D	H	HOLD M-8 LIMIT CLOSED
78	4E	L	LOCKOUT M-8 LIMIT CLOSED
79	4F	H	HOLD M-D LIMIT CLOSED
80	50	L	LOCKOUT M-D LIMIT CLOSED
81	51		Reserved for future use
82	52		Reserved for future use
83	53	L	LOCKOUT FLAME FAIL - PILOT
84	54	L	LOCKOUT 3-P INTLK OPEN - PILOT
85	55	L	LOCKOUT M-D LIMIT OPEN - PILOT
86	56	L	LOCKOUT T13 FVES OPEN - PILOT
87	57	L	LOCKOUT T13 FVES OPEN - POST PURGE
88	58	H	PCV MARG LIMIT
89	59	H	AUX1 MARG LIMIT
90	5A	H	AUX2 MARG LIMIT
97	61	L	PCV UNDER RANGE
98	62	L	PCV OVER RNG
99	63	L	PCV HIGH LIMIT
100	64	L	AUX1 UNDER RNG
101	65	L	AUX1 OVER RNG
102	66	L	AUX2 UNDER RNG
103	67	L	AUX2 OVER RNG
105	69	H	OUTDOOR TEMP > SETPOINT
106	6A	H	LAG1 DELAYED
107	6B	H	LAG1 DELAYED
108	6C	L	AUX1 HIGH LIMIT
109	6D	L	AUX2 HIGH LIMIT



DEC	HEX	STATE	TERMINAL	YZ300 INTERLOCK ANNUNCIATOR LOCKOUT MESSAGES
41	29	L	3-43	HIGH WATER
42	2A	L	43-44	LOW WATER
43	2B	L	51-52	HIGH GAS PRESSURE
44	2C	L	50-51	LOW GAS PRESSURE
92	5C	L	52-54	AUX GAS
45	2D	L	47-48	LOW OIL PRESSURE
56	38	L	44-46	HIGH OIL TEMPERATURE
46	2E	L	46-47	LOW OIL TEMPERATURE
47	2F	L	48-50	LOW ATOMIZING MEDIA
48	30	L	54-55	HIGH PRESSURE
49	31	L	55-56	HIGH TEMPERATURE
50	32	L	56-57	AUX #4 OPEN
51	33	L	57-58	AUX #5 OPEN
52	34	L	58-59	AUX #6 OPEN
53	35	L	59-60	AUX #7 OPEN
40	28	L	60-P	AIR FLOW OPEN
DEC	HEX	STATE	TERMINAL	YZ300 INTERLOCK ANNUNCIATOR HOLD MESSAGES
94	5E	H	L1-40	OP CONTROL OPEN
60	3C	H	40-41	L1-3 AUX #1 OPEN
61	3D	H	41-42	L1-3 AUX #2 OPEN
62	3E	H	42-3	L1-3 AUX #3 OPEN
63	3F	H-C	3-43	HIGH WATER
64	40	H-C	43-44	LOW WATER
65	41	H-C	51-52	HIGH GAS PRESSURE
66	42	H-C	50-51	LOW GAS PRESSURE
95	5F	H-C	52-54	AUX GAS
67	43	H-C	47-48	LOW OIL PRESSURE
96	60	H-C	44-46	HIGH OIL TEMPERATURE
68	44	H-C	46-47	LOW OIL TEMPERATURE
69	45	H-C	48-50	LOW ATOMIZING MEDIA
70	46	H-C	54-55	HIGH PRESSURE
71	47	H-C	55-56	HIGH TEMPERATURE
72	48	H-C	56-57	AUX #4 OPEN
73	49	H-C	57-58	AUX #5 OPEN
74	4A	H-C	58-58	AUX #6 OPEN
75	4B	H-C	59-60	AUX #7 OPEN
5	5	H-C	60-P	AIR FLOW OPEN

R = RUN H = HOLD L = LOCKOUT C = CHECK

OPERATIONAL FEATURES

4-20 mA TEST JACKS

For all amplifier types, the BurnerLogix provides 4-20 mA test jacks to represent the flame signal strength. The test jacks are located on the underside of the ZB module (pictured at right). The '+' jack is located next to COMMS port jack and the '-' jack is located next to the EXP port. Use caution so as NOT to plug the '-' jack into the EXP port. The test jacks accept standard plugs having a diameter of 0.078" (2mm). The maximum input impedance allowed is 100 ohms. The chart below correlates the test jack current to the numerical value shown on the display.

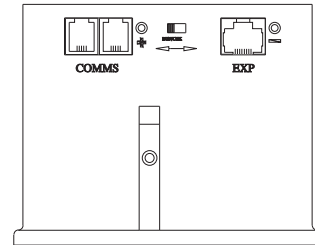
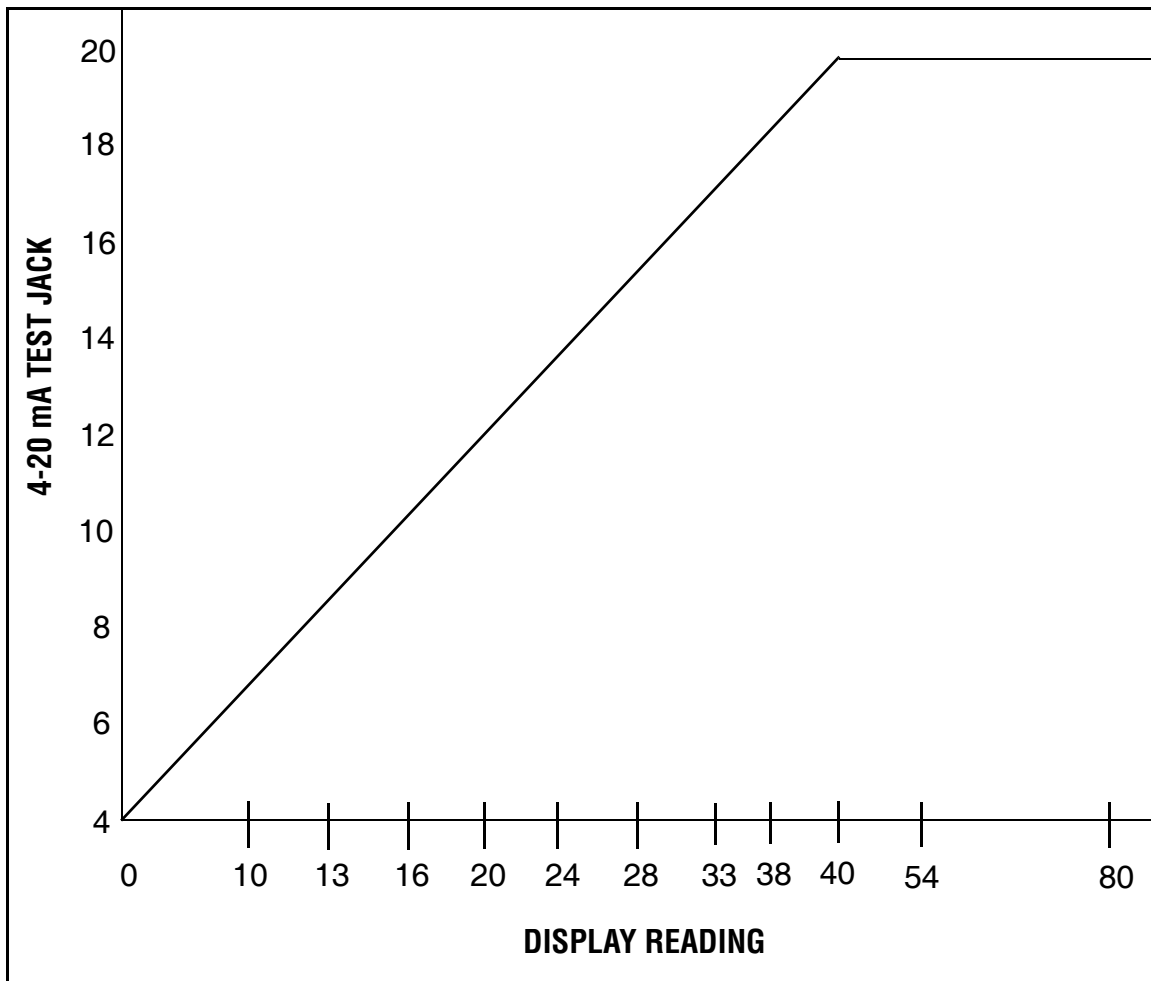
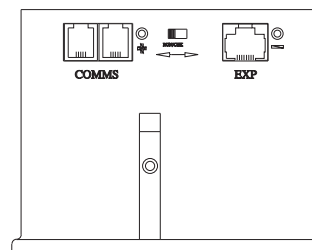

FIGURE 24.



CHECK-RUN SWITCH

The Check-Run switch is located on the underside of the ZB Chassis Module (note drawing on right) and can be used to stop the control in its firing sequence at any time in the burner sequence. It is designed to aid in set-up, start-up and check-out of the burner and its associated interlocks.



Following are the modes of operation:

1. When power is applied to the control (L1-L2) and the operating control circuit is closed (L1-3), the purge period begins and the firing rate motor is sent to the Hi Purge position. If the Check-Run Switch is moved to the Check position before the open damper 30 second purge period ends, the control will display:

CHECK 00:24
HIGH FIRE PURGE

The control will hold in this position indefinitely to allow the operator to make interlock switch and linkage adjustments. To continue in the cycle, move the Check-Run switch to Run to allow the control to advance.

2. If the Check-Run switch is moved to the Check position after the open damper purge period, but before low fire start period ends, the control will display:

CHECK 00:24
LOW FIRE PURGE

The control will hold in this position indefinitely to allow the operator to make interlock switch and linkage adjustments. To continue the cycle, moving the Check-Run Switch to Run will allow the control to advance.

3. During the PTFI period, switching to the Check position will stop the program in the PTFI period, allowing for pilot and/or scanner alignment adjustments to be made. The control will display:

CHECK 35
FLAME SIGNAL

It will hold in this position indefinitely as long as the flame signal strength is above the threshold of 10. If it drops below 10 for thirty (30) consecutive seconds, lockout will occur and the message on the display will read Flame Fail PTFI.

4. During the MTFI period, switching to the Check position will stop the program in the MTFI period. At this point it may be useful to inspect the position of the main flame at the burner head. Depending on where the switch is placed in check and depending on the selection of PTFI*MTFI TIMING, terminals 5, 6 and 7 could be energized simultaneously. The control will display:

CHECK 35
FLAME SIGNAL

If the unit is left in Check for longer than 2 minutes, the control will automatically advance to AUTO.

5. Switching from run to check during the burner on period will drive the modulator circuit to low fire. This allows for low fire fuel-air adjustments and holding the burner at low fire. Consult your boiler/burner instructions for low fire hold firing recommendations. The control will display:

CHECK 35
LOW FIRE SIGNAL

OPERATIONAL TEST



WARNING: Before testing the control operation on the boiler, close the manual main shut-off fuel valve. Failure to do this may cause injury or property damage.

Close the manual main shut-off fuel valve.

1. Recheck all limit circuit wiring for proper operation and correct connection.
2. Confirm that the automatic main fuel valves are wired to terminal “7.”
3. Power the control and electronically check the proper sequence of operation according to the YP100 Operating Sequence shown on page 51 of this bulletin.
4. After assuring yourself that all interlocks and valves are properly wired and that the sequence of operation is correct, open the manual main shut-off fuel valve and proceed cautiously through the boiler light off process. Check all safety interlocks for proper shut down of the boiler.

When the installation and all burner adjustments are completed, the entire burner control system should be tested in accordance with the burner manufacturer’s instructions. The procedure should verify the correct operation of:

1. Each operating control (temperature, pressure, etc.).
2. Each limit switch (temperature, pressure, low water cutoff, etc.).
3. Each interlock switch (airflow switch, high and low fuel pressure or temperature switches, purge and low fire start switches, fuel valve proof of closure interlock, etc.).
4. Pilot flame failure response and lockout.
5. Main flame failure response and lockout.
6. Tight shut off of all fuel valves.



CAUTION: LIVE VOLTAGE IS NECESSARY TO PERFORM THIS TEST.

Voltage Test

A Voltage Check is necessary to identify a potential problem with the supply to the control. This could be caused by an improperly sized or faulty transformer, faulty load coils or low entry voltage. Follow this procedure:

1. Monitor the L1-L2 supply throughout a complete burner cycle. The acceptable voltage range is 102V-132V. At no time during the cycle should the voltage dip below the minimum level.
2. Check other load terminal (M/L2, 5/L2, 6/L2, 7/L2) for voltage at improper times or improper values.

TEST CHECKOUT PROCEDURES

Normal Pilot Flame Test



CAUTION: Before making a pilot flame test, manually shut off the fuel supply to the main burner.

1. At the start of PTFI, place the RUN/CHK switch in the CHK position.
2. Observe the pilot flame signal on the display. If the average signal is below the minimum of 10, readjust the pilot flame or realign the flame detector.
3. During the pilot flame test, if flame is not detected for a continuous 30 seconds, the control will lockout. To re-establish the pilot flame trial for ignition (PTFI), manual reset of the lockout switch is required, and a complete prepurge accomplished.
4. When UV flame detection is used, a test is required to verify that UV radiation from the ignition spark is not being detected. To accomplish this, manually shut off both pilot and main fuels. Initiate a normal start-up, and when the PTFI display comes on, observe the display which should

read no signal more than 4. If more than 4 is observed, realign the UV scanner, and/or shield the spark from the scanner's view.

5. With all methods of flame detection, check pilot flame failure response by manually shutting off the pilot fuel and then initiate a normal start-up. With no pilot flame present, the control will de-energize the pilot assembly at the end of the trial for ignition interval, and the control will lock-out. Also check to verify that the ignition spark does not cause an electrical interference on infrared or flame rod applications.

Main Flame Test

Note: This test requires an interrupted pilot (a pilot that shuts off after main flame has been established).

1. Proceed through a normal startup. After the pilot flame is shut off, observe the reading on the display. If the signal reading is low, readjust main flame or realign detector.
2. Check main flame failure protection by manually shutting off the main fuel supply. Within 4 seconds after main flame goes out, the fuel valve will be de-energized. The alarm circuit will be energized following safety lockout.

Minimum Pilot Test



CAUTION: The minimum pilot test must be accomplished by a trained and qualified burner technician

This test assures that the flame detector will not detect a pilot flame too small to reliably light off the main flame. The test should be made on every new installation and following any repositioning or replacement of the flame detector. This procedure should not be used on a direct spark ignited burner.

1. Turn off the main fuel supply manually.
2. At the start of PTFI, place the Check-run switch in the check position.
3. Reduce the fuel supply to the pilot until the display reads below 10.
4. Slowly increase the fuel to the pilot until the display reads 10. This is minimum pilot flame that the flame detector will reliably detect.
5. Place the Check-run switch in the Run position. When the main fuel safety shut-off valve is energized, slowly open the manual main fuel valve.
6. Observe the light-off of the main flame. It must be smooth and normal.



CAUTION: If the main flame does not ignite immediately, shut off the main fuel. Realign the detector to require larger minimum pilot flame

7. Repeat the test until a reliable and smooth light-off occurs with the minimum pilot.
8. After this test is completed, increase the fuel to the pilot to its normal setting.

FIGURE 25.

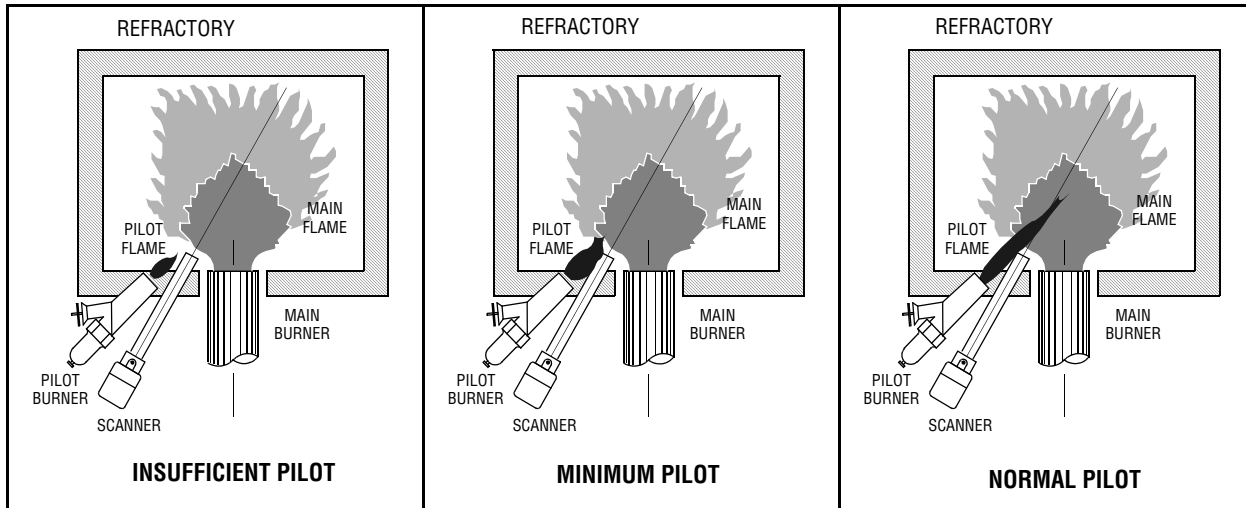

Scanner Wiring

Care should be taken to see that ignitor cables and scanner cables are routed away from one another on all installations. These cables, when crossed or run together, may interfere with the proper operation of the flame safeguard control.

If you are experiencing erratic operation or inappropriate characters on the display during the trial for ignition period, the cause is likely to be ignitor noise. Check for worn ignitor cable insulation, broken or cut insulation or loose connectors at the electrode and transformers

SUGGESTED GROUNDING RULES

The BurnerLogix system, being microprocessor based, requires a ground system that provides a zero-voltage reference. The voltage measured from L2 to all other terminals except L1 should be 0 volts.

1. The most effective ground is to run the ground wire in the same raceway as the hot and neutral from the main distribution service panel (not intermediate sub-panels) to the burner control panel and insure that this ground wire is well bonded to the control panel.
2. The wiring base of the BurnerLogix must have earth ground providing a connection between the sub-base and the control panel or the burner.
3. The earth ground wire must be capable of conducting the current to blow the 20A fuse in event of an internal short circuit. A number 14 AWG copper conductor is adequate, wide straps or brackets are preferred rather than lead wires.
4. The ground path needs to be low impedance (less than 1 ohm) to the equipment frame which in turn needs a low impedance to earth ground. For a ground path to be low impedance at RF frequencies, the connection must be made with minimum length conductors having maximum surface areas.
5. All connections should be free of nonconductive coatings and protected against rust.
6. Utilizing conduit as a means of providing a ground must be avoided.
7. Installing ground rods at the burner control panel defeats the purpose of a single point ground as described above and could also present a safety hazard.

Installation

Do not run high voltage ignition transformer wires in the same conduit with flame detection wiring. Do not run scanner wires in a conduit with line voltage circuits. Ensure the frame of the ignition transformer is securely connected to control panel frame or preferably the burner frame.

The BurnerLogix chassis (ZB110) contains a transient suppressing device connected internally across hot and neutral and to earth ground, terminal E. For this to be effective terminal E or the green wire in the pig-tail wiring base must be well grounded.



Remote Display

To locate the display remotely from the BurnerLogix control, mounting kits are available. These are Fireeye part numbers 129-178-4 or 129-178-8. Each kit contains a gasket, hardware to mount the display and a 4 or 8 foot cable.

Care must be taken not to route the ED580 cable in close proximity to any starter motor contactors located in the control panel or across any high voltage ignition wires. Refer to Fireeye bulletin E-8002 for proper installation.

Communications

When interfacing Fireeye controls to a communication system, be it a PLC or other microprocessor based device, ferrite cores should also be utilized. Proper twisted shielded pair cable must be utilized. In a multi-drop system, the shields should be tied together within a cabinet and not to any ground point. The shield at the source end of the cable of the multi-drop connection can then be terminated to ground. Source end is defined as the originating end of the communication system

Care must be taken not to route communication cables in close proximity to any starter motor contactors located in the control panel or across any high voltage ignition wires. Refer to Fireeye bulletin E-8002 for proper installation.

Scanners

The armored cable supplied with the Ultra-Violet and Infrared scanners should be connected to equipment by means of a good mechanical connection such as a conduit fitting. It may be necessary to utilize heat insulator (P/N 35-69) to isolate the sensing end of the scanner from boiler ground. Care must be taken not to route the scanner cable across the high voltage ignition cable. The high energy ignition cable should be checked periodically for cracking, connections and aging.

In applications using flame rod units, it may be beneficial to route a separate return wire from the S2 terminal to the flame rod assembly. This will minimize the effects of transient currents flowing into the BurnerLogix.

In all cases, scanner wires should be routed in separate conduit and not joined with any high voltage AC or ignition cables.

Maintenance

Periodically, the spark electrode should be inspected for proper gapping and cracked ceramics. At ignition time, the high energy from the ignition transformer will attempt to conduct to the point of least resistance and with an improper spark gap, where the conduction takes place will no longer be controlled.

The VA rating of the control transformer must be sized to handle the inrush currents of the pilot solenoid and ignition transformer at PTFI and then the inrush currents of the main fuel valve assembly at MTFI time.

Inspect neatness of wiring in junction boxes and cabinets. It is best to have connections short and direct and also not having wires bunched up and tied off. Also, connections should be periodically inspected for tightness and corrosion

Type 48PT2 Infrared and Type UV1A, UV2, 45UV5 Ultraviolet Scanners

The viewing area of the scanner must be kept clean. Even a small amount of contamination will reduce the flame signal reaching the detector by a measurable amount. Wipe the viewing area routinely using a soft cloth dampened with concentrated detergent.

— Type 48PT2 Scanners include a replaceable #4-263-1 Firetron cell.

— Type 45UV5 Scanners include a replaceable #4-314-1 UV tube.

Type 69ND1 Flame Rod

The flame rod and its insulator should be kept clean by washing routinely with soap and water. Rods should be routinely replaced as they oxidize.



Flame Signal Strength

Routine observation of the flame signal strength will forewarn any deterioration in the capability of the flame detector or its application.

Contacts

There are no accessible contacts in the BurnerLogix. Where contacts are used, their design assures long trouble-free life when the load circuits are maintained within the published load ratings.

Humidity

In areas of high humidity, the control chassis should be removed and placed in a dry atmosphere when the system is expected to be out of service for an extended period.

Periodic Safety Check

It is recommended that a procedure be established to test the complete flame safeguard system at least once a month. This test should verify the proper operation of all limit switches and safety interlocks as well as flame failure protection and fuel safety shutoff valve tightness.

Rotation

It is recommended that control and scanner units purchased as spares be installed periodically to ensure proper operation.



BURNERLOGIX Z PROGRAMMING / SETUP GUIDE

JOB:				DATE:			
SETPOINT	UNUSED	SETTING	NOTES				
MOD USE			AUTO	MAN			
MOD POS			0-100%				
MOD MAX			0-100%				
PCV INPUT			STEAM	WATER			
PCV PRES			0-15P	0-30P	0-200P	0-300P	
STM STPT							
CUT IN							
CUT OUT							
MOD RNG							
MGRNL ALM							
LIMIT ALM							
PCV TEMP			32-350F	32-752F			
WTR STPT							
CUT IN							
CUT OUT							
MOD RNG							
MGRNL ALM							
LIMIT ALM							
INTEGRAL TRM			0-100				
DERIVATV TRM			0-100				
AUX1 USE			STACK TEMP	MNITR TEMP	STNDBY WTR	PRES	
AUX1 TEMP			32-350F	32-752F			
AUX1 PRES			0-15P	0-30P	0-200P	0-300P	
STNDBY STPT							
CUT IN							
CUT OUT							
MOD RNG							
MGRNL STACK							
LIMIT STACK							
AUX2 USE			STACK TEMP	OUTDR TEMP	MNITR TEMP	PRES	
AUX2 TEMP			32-350F	32-752F			
AUX2 PRES			0-15P	0-30P	0-200P	0-300P	
MGRNL STACK							
LIMIT STACK							
OUTDR STPT							



SETPOINT	UNUSED	SETTING	NOTES					
LAG1 MODE			LAG					
LAG1 STPT								
CUT IN								
CUT OUT								
MOD RNG								
STRT DLY			0 to 15 min					
LAG DLY			0 to 15 min					
MOD MAX								
LAG2 MODE			LAG	RESET	P-HOLD	I-HOLD	PROCESS	FRCD ON
LAG2 STPT								
CUT IN								
CUT OUT								
MOD RNG								
STRT DLY			0 to 15 min					
LAG DLY			0 to 15 min					
MOD MAX								
THML SHK			LOW FIRE	SEGMENT				
THML START								
THML EXIT								
THML LF			Low fire modulating position during thermal shock					
THML OVRD			0 to 60 min					
PROGRAM SETUP VALUES								
PURGE			30 sec to 60 min					
CNT METHOD			DOWN	UP				
PROVE 3-P OPEN			NO	YES				
PTFI*MTFI TIMING			10/10*10/15	10/10*10/10	10/10*0/5	10/10*0/10	5/10*0/10	5/10*0/15
			5/5*0/10	5/5*0/5	5/5*10/15	5/5*10/10		
TERMINAL 6			INTRP	INTMT				
PROVE M-8 OPEN			NO	YES				
PROVE M-D OPEN			NO	YES				
POST PURGE			15 to 60 sec					
M-D WAIT 10m			NO	YES				
PROVE M-D TFI			NO	YES				
BAUD RATE			4800	9600	19200			
UNIT ADDRESS			0-31					



NOTES



NOTICE

When Fireeye products are combined with equipment manufactured by others and/or integrated into systems designed or manufactured by others, the Fireeye warranty, as stated in its General Terms and Conditions of Sale, pertains only to the Fireeye products and not to any other equipment or to the combined system or its overall performance.

WARRANTIES

FIREYE guarantees for *one year from the date of installation or 18 months from date of manufacture* of its products to replace, or, at its option, to repair any product or part thereof (except lamps and photocells) which is found defective in material or workmanship or which otherwise fails to conform to the description of the product on the face of its sales order. **THE FOREGOING IS IN LIEU OF ALL OTHER WARRANTIES AND FIREYE MAKES NO WARRANTY OF MERCHANTABILITY OR ANY OTHER WARRANTY, EXPRESS OR IMPLIED.** Except as specifically stated in these general terms and conditions of sale, remedies with respect to any product or part number manufactured or sold by Fireeye shall be limited exclusively to the right to replacement or repair as above provided. In no event shall Fireeye be liable for consequential or special damages of any nature that may arise in connection with such product or part.



FIREYE®
3 Manchester Road
Derry, New Hampshire 03038 USA
www.fireeye.com

BLZ-1001
JANUARY 30, 2014
Supersedes July 15, 2013