

Selectra®

14 & 44 Condensed Catalog

Electronic Modulation Gas-Fired Temperature Controls/ Direct Fired Applications

Selectra® systems from Maxitrol maintain precise, stable gas-fired temperatures. Selectra's unique electronic Modulator or Modulator-Regulator valves control gas flow with instantaneous response and continual adjustment. They are the superior alternative to mod motors and butterfly valves.

OEM or retrofit applications include environmental climate control, as well as industrial or commercial heating processes. Standard temperature adjustment range 55° to 90° F. All fuel gases are compatible - capacities to 30,000,000 Btu/h.

Available standard companion electronics include temperature selectors, amplifiers, and temperature sensors, in a variety of configurations. The amplifier supplies output voltage to the M/MR valve.

MAKE UP AIR APPLICATIONS

Series 14 System

Selectra® Series 14 systems are designed primarily for make-up air heating, as components of direct fired equipment.

A discharge air temperature sensor is mounted within a mixing tube housing.

Amplifiers are available with low-fire start duration, and integral or remote temperature selection.

Options:

- A room override thermostat provides space temperature control by raising the discharge air temperature to a preselected point - when used in conjunction with the remote temperature selector.
- An inlet air sensor (and mixing tube) provides inverse change in discharge air for each degree change in inlet air - when installed in a convenient duct location upstream of the burner.
- A dual temperature selector replaces TD114 to provide dual control for door heaters, or other applications such as paint spray booths.

SPACE HEATING APPLICATIONS

Series 44 System

Selectra® Series 44 systems are designed primarily for space heating, as components of direct fired equipment.

A wall mounted Selectrastat® senses space temperature and has an integral selector with either a 55° to 90° F or 40° to 80° F range. A discharge air temperature sensor (and mixing tube) is a means of limiting the minimum and maximum discharge air temperature.

Amplifiers are available with low-fire start duration feature.

Option:

- Instead of a Selectrastat, a separate remote temperature sensor and selector can be substituted.

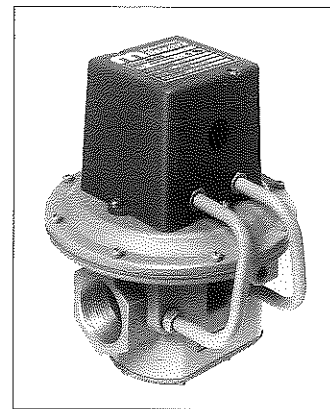

Figure 1 : MR212



Figure 2 : M611



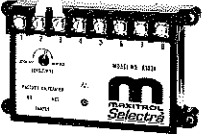



Figure 3 : M411



MAKE UP AIR APPLICATIONS - Series 14 System

Series 14 Basic System					Options	
Valves	Amplifier or Amplifier-Selector	Selection Method	Remote Selector Model (if applicable)	Sensor	Override Stat	Inlet Air Sensor
M411, M511, M611, MR212D, E, G, or J (see pg. 4)	A1014, A1014U	Single Remote	TD114	TS114/ MT1 or 2	T115	TS10765
		Dual Remote	TD114HD TD214	TS114/ MT1 or 2 TS214/ MT1 or 2	—	—
	AD1014U	Single Integral	—	TS114/ MT1 or 2	—	TS10765
	AD1214	Dual Integral	—	TS214/ MT1 or 2	—	—

Note: Selector and sensor must have the same temperature range to be compatible.

SYSTEM COMPONENTS

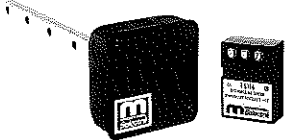
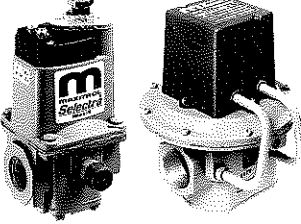
Amplifiers (A1014 shown)	
	A1014 (all temperature ranges) A1014U (replaces A1014L1, suitable replacement for A1014)(all temperature ranges - includes 10 or 20 second low fire start capability)
Amplifier-Selectors (with integral temperature dial)	
	AD1014U (shown) (replaces AD1014 and AD1014L1)(all temperature ranges - includes 10 or 20 second low fire start capability)
Dual Temperature Amplifier-Selectors: (AD1214 shown)	
	AD1214__ (integral dual selector - any comb. of 2 standard ranges avail.) Example1 - AD1214BC (120° to 170° F and 160° to 210° F, use w/TS214BC) Example2 - AD1214AD (80° to 130° F and 200° to 250° F, use w/TS214AD)
Remote Temperature Selectors:	
	TD114 (55° to 90° F w/override 0° to 40° over set point) TD114A (80° to 130° F) TD114A-1 (80° to 130° F w/ override 0° to 40° F over set point) TD114B (120 to 170° F) TD114C (160° to 210° F) TD114D (200° to 250° F)
TD114E (100° to 250° F) TD114F (40° to 80° F w/override 0° to 40° over set point) TD114G (90° to 140° F) TD114-1 (55° to 90° F w/120° to 170° F override) * use w/TS114 TD114-2 (55° to 90° F w/two outputs) TD114G-2 (90° to 140° F w/two outputs) NOTE: Remote Selector and Discharge Temperature Sensor must have same temperature range to be compatible. Optional: ETD-1 enclosure, EFP-1 cover plate only - no enclosure	
Discharge Air Temperature Sensors: use with Mixing Tube	
TS114 (55° to 90° F) TS114A (80° to 130° F) TS114B (120° to 170° F) TS114C (160° to 210° F) TS114D (200° to 250° F) TS114E (100° to 250° F) TS114F (40° to 80° F) TS114G (90° to 140° F) TS114J (110° to 160° F) To be used w/ AD1014-1116	

TS214__ (dual sensor - any combination of 2 standard ranges available) Example 1 - TS214G (55° to 90° F and 90° to 140° F, use w/TD114 & TD114G, or TD214G [selector w/switch], or AD1214G) Example 2 - TS214AD (80° to 130° F and 200° to 250° F, use w/TD114A & TD114D, or TD214AD [selector w/ switch], or AD1214AD)	
Mixing Tubes: (and sensor)	
	MT1-9 or 2-9 (9" length) MT1-12 or 2-12 (12" length) MT1-23 or 2-23 (23" length) MT1-28 or 2-28 (28" length) MT1-57 (57" length)
Valves:	
	M411 (3/8" & 1/2" pipe size) M511 (1/2" & 3/4" pipe size) M611 (3/4" & 1" pipe size) MR212D (1", 1-1/4", 1-1/2" pipe size) MR212E (1-1/2" & 2" pipe size) MR212G (2-1/2" & 3" pipe size) MR212J (4" flanged) MR212-2D, E, G, J (used for 2-speed blower or dual fuel operation) NOTE: M (Modulator) valve requires a pressure regulator for high fire setting. MR (Modulator-Regulator) valve requires no pressure regulator up to 5 psi.
	

OPTIONAL SYSTEM COMPONENTS:

Dual Temperature Selector:

DOOR HEATERS -TD114HD use w/TS114 (door closed 55° to 90° F/open 90° to 140° F)
PAINT SPRAY BOOTHS OR OTHER DUAL APPLICATIONS-
TD214__ (dual selector w/switch - any comb. of 2 standard ranges avail.)
Example 1-TD214G(55°to90° F[spray]and90°to140° F[dry],usew/TS214G
Example 2 - TD214AD (80° to 130° F and 200° to 250° F, use w/TS214AD
TD214__X (same as TD214__, less enclosure)

Inlet Air Temperature Sensors: use with Mixing Tube

TS10765A (8:1 ratio)
TS10765B (5:1 ratio)
TS10765C (3.5:1 ratio)

Override Stat: (use only with TD114, F,-1, A-1)







 T115 (40° to 90° F)

SPACE HEATING APPLICATIONS - Series 44 System

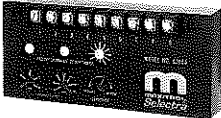
Series 44 Basic System				Options	
Valves	Amplifier	Selectrstat	Discharge Temp. Sensor	Space Temperature Selector	Space Temperature Sensor
M411, M511, M611, MR212D, E, G, or J (see pg. 4)	A1044, A1044U	T244	TS144 / MT1 or 2	TD244	TS244

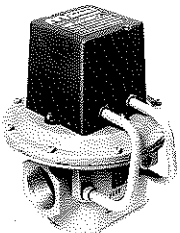
Note: Selector and sensor must have same temperature range to be compatible.

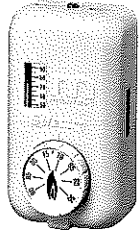
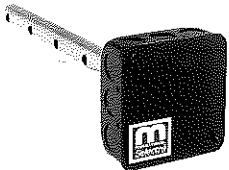
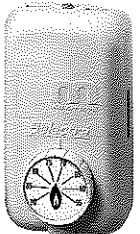
SYSTEM COMPONENTS

Amplifiers		Valves	
 <p>A1044U</p>  <p>A1044 Amplifier</p>  <p>A1044L Amplifier</p>	<p>A1044U (replaces all A1044L1, suitable replacement for A1044 [C,D,E,H]) (includes 0, 10, or 20 second low fire start capability.) A1044UF (replacement for A1044FL1) A1044UG (replacement for A1044G[L1])</p> <p>A1044 (min. 40° to 80° F/max. 80° to 140° F) A1044C (min. 20° to 60° F/max. 80° to 140° F) A1044D (min. 20° to 60° F/max. 35° to 75° F) A1044E (min. 20° to 60° F/max. 60° to 120° F) A1044G (min. 40° to 80° F/max. 160° to 210° F) A1044H (min. 40° to 80° F/max. 100° to 160° F)</p> <p>NOTE: Amplifier and Discharge Temperature Sensor must have same temperature range to be compatible.</p>	  <p>M411 (3/8" & 1/2" pipe size) M511 (1/2" & 3/4" pipe size) M611 (3/4" & 1" pipe size) MR212D (1", 1 1/4", 1 1/2" pipe size) MR212E (1 1/2" & 2" pipe size) MR212G (2 1/2" & 3" pipe size) MR212J (4" flanged) MR212D-2, E-2, G-2 & J-2 (same pipe sizes as MR212D-J except used for 2-speed blower or dual fuel operation)</p> <p>NOTE: M (Modulator) valve requires an upstream pressure regulator for low fire & high fire settings. MR (Modulator/Regulator) valve requires no upstream pressure regulator up to 5 psi inlet.</p>	
Discharge Temperature Sensors: use with Mixing Tube		Selectrstat (Senses and Selects)	
	<p>Sensors compatible with A1044U: TS144 (min. 40° to 80° F/max. 80° to 140° F) TS144C (min. 20° to 60° F/max. 80° to 140° F) TS144D (min. 20° to 60° F/max. 35° to 75° F) TS144E (min. 20° to 60° F/max. 60° to 120° F) TS144H (min. 40° to 80° F/max. 100° to 160° F)</p> <p>Sensors compatible with A1044UF: TS144F (min. 40° to 80° F / max. 60° to 95° F)</p> <p>Sensors compatible with A1044UG: TS144G (min. 40° to 80° F/max. 160° to 210° F)</p>	 <p>T244 (55° to 90° F) T244A (40° to 80° F) or optional pair to replace Selectrstat</p>	
Mixing Tubes: used with sensors		Space Temperature Selector	
	<p>MT1-9 or MT2-9 (9" length) MT1-12 or MT2-12 (12" length) MT1-23 or MT2-23 (23" length) MT1-28 or MT2-28 (28" length) MT1-57 (57" length)</p>	 <p>TD244 (wall mount 55° to 90° F) TD244A (wall mount 40° to 80° F) TD244P (panel mount 55° to 90° F) TD244AP (panel mount 40° to 80° F)</p>	
		Space Temperature Sensor	
		 <p>TS244 (55° to 90° F) TS244A (40° to 80° F)</p> <p>NOTE: Space Temperature Selector and Space Temperature Sensor must have same temperature range to be compatible.</p>	

PRESSURES, DIMENSIONS

Valve Dimensions - in inches (millimeters)

Dimensions are to be used only as an aid in designing clearance for the valve.
Actual production dimensions may vary somewhat from those shown.

Model Number	Swing Radius	Call-Outs			
		A	B	C	D
M411	3.1 (79)	3.9 (100)	2 (51)	2.1 (54)	.9 (24)
M511	4.3 (109)	5.3 (135)	3.25 (83)	3.4 (86)	1.2 (30)
M611	7.2 (183)	7.4 (188)	3.9 (99)	4 (102)	1.5 (37)
MR212D	8.1 (206)	10.2 (259)	7 (178)	5.5 (140)	2.3 (59)
MR212E	8.6 (218)	11.25 (286)	9.1 (232)	8 (203)	3 (76)
MR212G	10.4 (264)	14.75 (375)	13.5 (343)	11.75 (298)	4.6 (118)
MR212J*	—	24 (610)	21.5 (546)	13.9 (352)	5.9 (149)

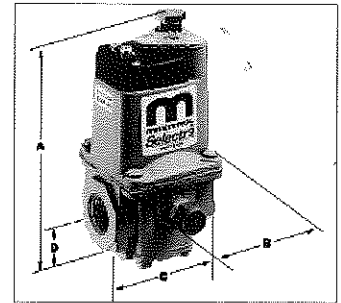

Figure 4 : M411, 511

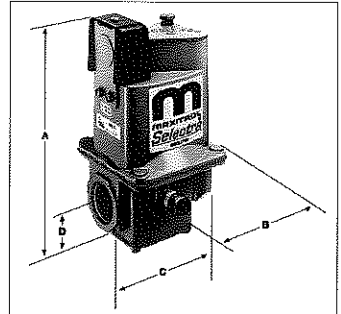

Figure 5 : M611

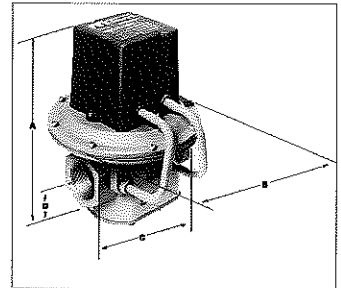

Figure 6 : MR212



M411, M511, M611 - CSA tested for 1/2 psi inlet pressure, Maxitrol tested for 1 psi maximum operating inlet pressure.

MR212D, E, G, J - CSA rated for 5 psi inlet pressure, Maxitrol tested for 5 psi maximum operating inlet pressure.

See Bulletin MMR_MT_EN for additional valve information.

Series 14 System	Series 44 System
A1014 Amplifier 4.51" (115) x 2.62" (67) x 1.34" (34)	A1044 Amplifier 5.75" (146) x 2.62" (67) x 1.34" (34)
AD1014 Amplifier/Selector, A1014U Amplifier 6" (152) x 3.38" (86) x 2" (51)	A1044L Amplifier 6" (152) x 3.38" (86) x 2" (51)
AD1214 Dual Temp. Amplifier-Selector 5.75" (146) x 2.62 (67) x 1.34" (34)	T244 Selectrastat 2.56" (65) x 4.5" (114) x 1.79" (46)
TD114 Remote Temp. Selector 2.62" (67) x 3" (76) x 1.75" (44)	TD244 Space Temp. Selector 2.56" (65) x 4.5" (114) x 1.79" (46)
TD114S Dual Temp. Selector 6" (152) x 4" (102) x 2" (51)	TS244 Space Temp. Sensor 2.56" (65) x 4.5" (114) x 1.53" (39)
T115 Override Stat 2.96" (75) x 4.69" (119) x 2.56" (65)	MT1 Mixing Tube enclosure (for TS144 sensor) 4.19" (106) x 4.19" (106) x 1.88" (48) [Tube lengths: 9" (229), 12" (305), 23" (584), 28" (711), 57" (1448)]
ETD- 1 (opt. TD114 enclosure), MT1 Mixing Tube encl. (for sensor) 4.19" (106) x 4.19" (106) x 1.88" (48) [Tube lengths: 9" (229), 12" (305), 23" (584), 28" (711), 57" (1448)]	MT2 Mixing Tube enclosure (for TS144 sensor) 2.19" (56) x 4.19" (106) x 1.88" (48) [Tube lengths: 9" (229), 12" (305), 23" (584), 28" (711)]
MT2 Mixing Tube enclosure (for sensor) 2.19" (56) x 4.19" (106) x 1.88" (48) [Tube lengths: 9" (229), 12" (305), 23" (584), 28" (711)]	

Dimensions are to be used only as an aid in designing clearance. Actual production dimensions may vary somewhat from those shown.

MAXITROL