

**Westwood** electrodes & insulators  
HIGH DIELECTRIC STRENGTH • PRECISION DIMENSIONS

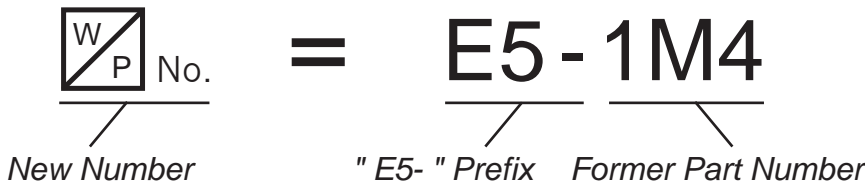

**NOTE: Electrode and related items part numbers are now "E5-" followed by the former number.**

Example:



**Type 1M**

Insulator length	W/P No.
4"	E5-1M4
4-1/4"	E5-1M4-1/4
4-1/2"	E5-1M4-1/2
5"	E5-1M5
6"	E5-1M6
7"	E5-1M7
8"	E5-1M8

**Type 2M**

Insulator length	W/P No.
4"	E5-2M4
4-1/2"	E5-2M4-1/2
5"	E5-2M5
5-1/2"	E5-2M5-1/2
6"	E5-2M6
7"	E5-2M7
8"	E5-2M8

**Type 3M**

Insulator length	W/P No.
4"	E5-3M4
4-1/2"	E5-3M4-1/2
5"	E5-3M5
5-1/2"	E5-3M5-1/2
6"	E5-3M6
7"	E5-3M7
8"	E5-3M8

**Type 4M**

Insulator length	W/P No.
4"	E5-4M4
4-1/4"	E5-4M4-1/4
4-1/2"	E5-4M4-1/2
5"	E5-4M5
6"	E5-4M6
7"	E5-4M7
8"	E5-4M8

**Type 5M**

Insulator length	W/P No.
4"	E5-5M4
5"	E5-5M5
6"	E5-5M6

**Type 2F**

Insulator length	W/P No.
4"	E5-2F4
4-1/2"	E5-2F4-1/2
5"	E5-2F5
5-1/2"	E5-2F5-1/2
6"	E5-2F6
7"	E5-2F7
8"	E5-2F8

**Type 3F**

Insulator length	W/P No.
4"	E5-3F4
4-1/2"	E5-3F4-1/2
5"	E5-3F5
5-1/2"	E5-3F5-1/2
6"	E5-3F6
7"	E5-3F7
8"	E5-3F8

Note: To order the insulator only for any electrode found on this page, add "INS" to the part number.

**Westwood** electrodes & insulators

HIGH DIELECTRIC STRENGTH • PRECISION DIMENSIONS

<p>Ace "A" E5-100 Ace 5" E5-100B Ace 6" E5-100C Ace 7"</p>	<p>ABC (with bracket) E5-130</p>	<p>ABC E5-147</p> <p>ABC E5-148</p>
<p>Acme E5-102A</p>	<p>ABC (with bracket) E5-130A</p>	<p>ABC E5-148A</p>
<p>Acme E5-102B</p>	<p>ABC (with bracket) E5-130A</p>	<p>ABC E5-148B</p>
<p>Acme E5-107</p>	<p>ABC E5-131A ABC 4" E5-132A ABC 5"</p>	<p>ABC E5-148C</p>
<p>Aero E5-109</p>	<p>ABC E5-131A ABC 4" E5-132A ABC 5"</p>	<p>ABC ← with 6" spring E5-148K</p>
<p>Aero E5-110</p>	<p>ABC E5-131 ABC 4" E5-132 ABC 5"</p>	<p>ABC E5-148M</p>
<p>Aero E5-110B</p>	<p>ABC E5-131 ABC 4" E5-132 ABC 5"</p>	<p>ABC Sunray OE-1 E5-148Q</p>
<p>Aero "A" E5-111A Aero none E5-111D Aero 9-1/2" E5-111E Aero 13-1/2" E5-111F Aero 4-3/4" E5-111G Aero 7-1/2"</p>	<p>ABC E5-133</p>	<p>ABC Sunray "A" "B" "C" E5-148R ABC Sunray 7/16" 3-1/4" 3/4" E5-148R1 ABC Sunray 7/16" 4-1/4" 1/4" E5-148S ABC Sunray 15/16" 3-1/4" 3/4"</p>
<p>Arco E5-123</p>	<p>ABC "A" E5-137B ABC 1-1/2" E5-137C ABC 4-1/4" E5-137E ABC 7-1/2"</p>	<p>Beckett E5-151A</p>
<p>Arco E5-126</p>	<p>ABC 6" E5-144A ABC 5" E5-144B ABC 4-1/2" E5-144C ABC 4" E5-144D ABC 3" E5-144E ABC 2" E5-144F ABC 1-3/4" E5-144G ABC None E5-144H</p>	<p>Beckett E5-151B</p>
<p>Arco E5-127</p>	<p>ABC E5-146</p>	<p>Beckett E5-151C</p>
<p>Arco E5-127A</p>	<p>ABC E5-146</p>	<p>Beckett E5-151D</p>
<p>Armstrong E5-128</p>	<p>ABC "A" E5-146A ABC 4-1/4" E5-146B ABC none E5-146C ABC 4-1/2"</p>	<p>Beckett E5-151E</p>
		<p>spring Beckett E5-151E1</p>

**Westwood** electrodes & insulators

HIGH DIELECTRIC STRENGTH • PRECISION DIMENSIONS

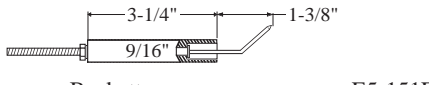
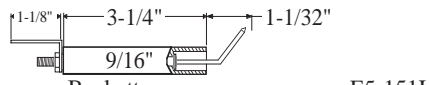
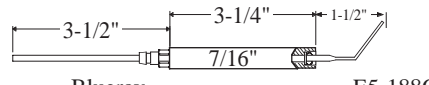
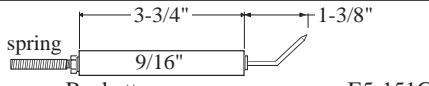
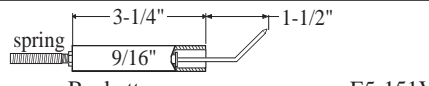
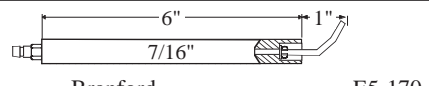
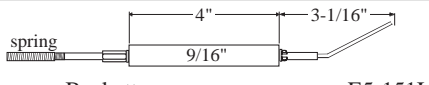
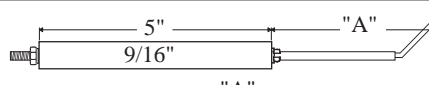
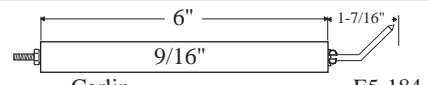
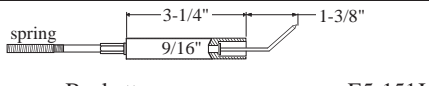
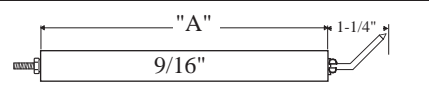
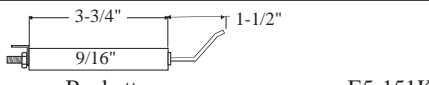
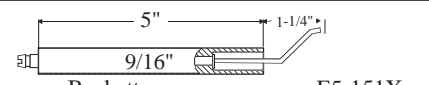
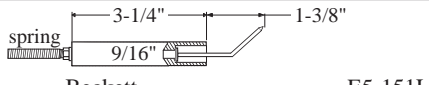
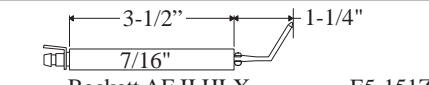
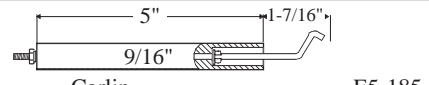
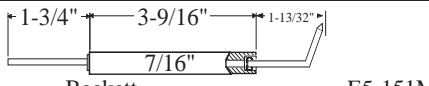
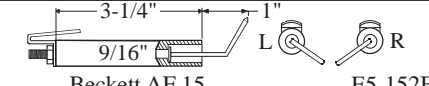
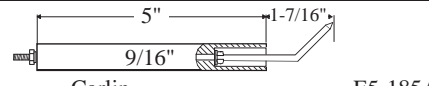
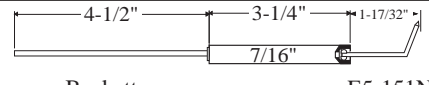
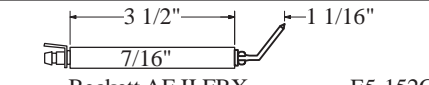
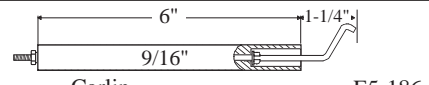
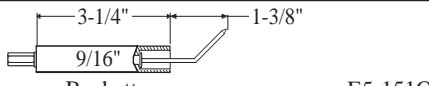
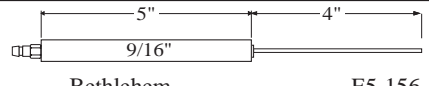
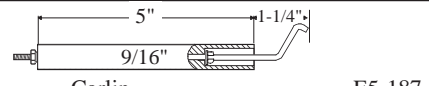
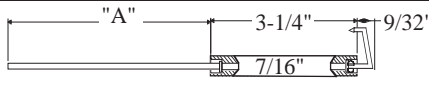
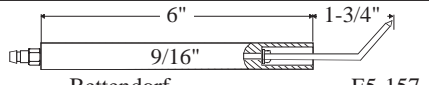
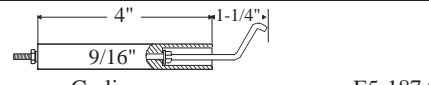
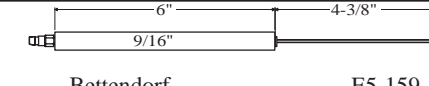
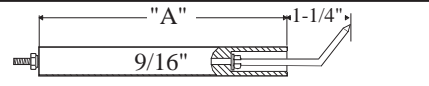
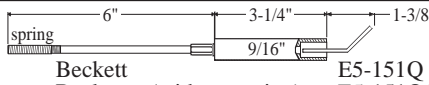
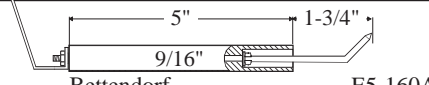
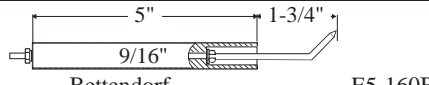
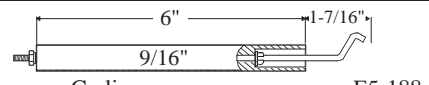
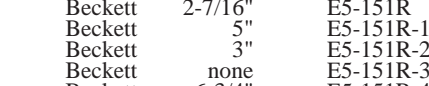
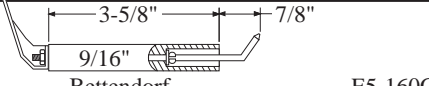
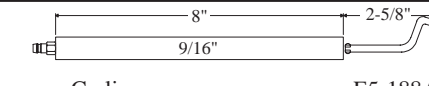
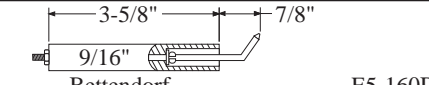
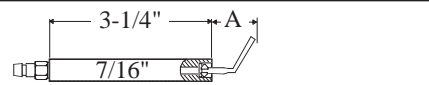
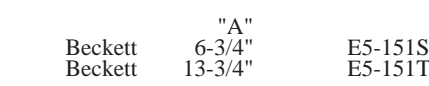
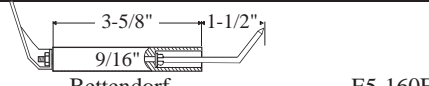
 Beckett E5-151F	 Beckett E5-151U	 Blueray E5-1880
 Beckett E5-151G	 Beckett E5-151V	 Branford E5-170
 Beckett E5-151I	 Beckett E5-151A	 Carlin E5-184
 Beckett E5-151J	Beckett 1-1/4" E5-151 Beckett 3-1/4" E5-152 Beckett 5" E5-152A Beckett 6-1/4" E5-153 Beckett 1-1/2" E5-153A	 Carlin E5-184A-C
 Beckett E5-151K	 Beckett E5-151X	Carlin "A" E5-184A Carlin 4" E5-184B Carlin 5" E5-184C Carlin 6" E5-184C
 Beckett E5-151L	 Beckett AF II HLX E5-151Z	 Carlin E5-185
 Beckett E5-151M	 Beckett AF 15 E5-152B	 Carlin E5-185A
 Beckett E5-151N	 Beckett AF II FBX E5-152C	 Carlin E5-186
 Beckett E5-151O	 Bethlehem E5-156	 Carlin E5-187
 Beckett E5-151P	 Bettendorf E5-157	 Carlin E5-187A
Beckett "A" E5-151P Beckett 5" E5-151P1 Beckett 2" E5-151P2 Beckett 3/4" E5-151P2	 Bettendorf E5-159	 Carlin E5-187B-C
 Beckett E5-151Q	 Bettendorf E5-160A	Carlin "A" E5-187B Carlin 5" E5-187C Carlin 6" E5-187C
Beckett (without spring) E5-151Q1	 Bettendorf E5-160B	 Carlin E5-188
 Beckett E5-151R	 Bettendorf E5-160C	 Carlin E5-188A
Beckett "A" E5-151R Beckett 2-7/16" E5-151R-1 Beckett 5" E5-151R-2 Beckett 3" E5-151R-3 Beckett none E5-151R-3 Beckett 6-3/4" E5-151R-4	 Bettendorf E5-160D	 Carlin E5-188B
 Beckett E5-151S	 Bettendorf E5-160E	Carlin "A" E5-188B Carlin 7/8" E5-188B Carlin 1-9/16" E5-188B2
Beckett 6-3/4" E5-151S Beckett 13-3/4" E5-151T		

**Westwood** electrodes & insulators

HIGH DIELECTRIC STRENGTH • PRECISION DIMENSIONS

 Carlin E5-188C	 Carlin E5-188O	 Cleanburn E5-199Z1																
 Carlin E5-188D	 Carlin E5-188P	 Cleaver Brooks E5-201																
 Carlin E5-188E	 Carlin E5-188Q	 Cleaver Brooks E5-203																
 Carlin E5-188F	 Carlin E5-188R2	 Cleaver Brooks E5-204A																
 Carlin E5-188G	<table border="0"> <tr> <td></td> <td>"A"</td> <td>"B"</td> <td></td> </tr> <tr> <td>Carlin</td> <td>7/8"</td> <td>12"</td> <td>E5-188R2</td> </tr> <tr> <td>Carlin</td> <td>1-9/16"</td> <td>12"</td> <td>E5-188R3</td> </tr> <tr> <td>Carlin</td> <td>7/8"</td> <td>15"</td> <td>E5-188R4</td> </tr> </table>		"A"	"B"		Carlin	7/8"	12"	E5-188R2	Carlin	1-9/16"	12"	E5-188R3	Carlin	7/8"	15"	E5-188R4	 Cleaver Brooks E5-205
	"A"	"B"																
Carlin	7/8"	12"	E5-188R2															
Carlin	1-9/16"	12"	E5-188R3															
Carlin	7/8"	15"	E5-188R4															
 Carlin E5-188H	 Century E5-189	 Cleaver Brooks E5-205A																
 Carlin E5-188I	 Century E5-191	 Cleaver Brooks E5-205A1																
 Carlin E5-188J	 Century E5-191A	 Cleaver Brooks E5-205A2																
 Carlin E5-188K	 Century E5-191B	 Cleaver Brooks E5-205B																
 Carlin E5-188L	 Chief E5-192	 Carlin E5-188N																
 Carlin E5-188M	 Chief E5-192B	 Carlin E5-188N1																
 Carlin E5-188N2	 Clayton E5-198	 Carlin E5-188N3																
 Carlin E5-188N4	 Clayton E5-199	 Carlin E5-188N5																
 Carlin E5-188N7	 Clayton E5-199A	 Carlin E5-188N6																
 Carlin E5-188N8	 Clayton E5-199D	 Carlin E5-188N8																
 Carlin E5-188N9	 Cleanburn E5-199Z	 Cleaver Brooks E5-205F																
 Carlin E5-188N10	 Cleaver Brooks E5-205G	 Cleaver Brooks E5-205H																
	 Cleaver Brooks E5-205I	 Cleaver Brooks E5-205J																
		 Cleaver Brooks E5-205K																
		 Cleaver Brooks E5-205L																
		 Cleaver Brooks E5-205M																
		 Cleaver Brooks E5-205N																

Please order by No.

rev. 03-07-17

**E4**

**Westwood** electrodes & insulators

HIGH DIELECTRIC STRENGTH • PRECISION DIMENSIONS

<p>Cleaver Brooks E5-205T</p>	<p>Delco E5-225</p>	<p>Dravo E5-232N</p>
<p>Cleaver Brooks E5-205U</p>	<p>Delco E5-227</p>	<p>Dravo E5-233</p>
<p>Cleaver Brooks E5-205V</p>	<p>Delco E5-228</p>	<p>Ducane "A" none E5-234A                  Ducane 1-7/8" E5-234B                  Ducane 3-7/8" E5-234C                  Ducane 5-7/8" E5-234D</p>
<p>Cleaver Brooks E5-205X</p>	<p>Dravo E5-232</p>	<p>Ducane "A" none E5-234E                  Ducane 2-1/4" E5-234F                  Ducane 4-1/4" E5-234G                  Ducane 6-1/4" E5-234H                  Ducane 12-1/4" E5-234I                  Ducane 20-1/4" E5-234J</p>
<p>Cleaver Brooks E5-205Y</p>	<p>Dravo E5-232A</p>	<p>Ducane "A" none E5-234K                  Ducane OilMaster™ 2-3/4" E5-234L                  Ducane OilMaster™ 4-3/4" E5-234M</p>
<p>Cleaver Brooks E5-205Z</p>	<p>Dravo E5-232B</p>	<p>Ducane "A" none E5-234M</p>
<p>Cleaver Brooks E5-205Z2</p>	<p>Dravo E5-232C</p>	<p>Ducane "A" none E5-234N</p>
<p>Cleaver Brooks E5-205Z3</p>	<p>Dravo E5-232D</p>	<p>Eclipse "A" 7-3/4" E5-235                  Eclipse 11" E5-235A                  Eclipse 15" E5-235B</p>
<p>Coleman E5-202A</p>	<p>Dravo E5-232E</p>	<p>Eclipse "A" none E5-236</p>
<p>Coleman E5-202B</p>	<p>Dravo E5-232F</p>	<p>Eclipse "A" none E5-237</p>
<p>Columbia Boiler E5-206</p>	<p>Dravo E5-232G</p>	<p>Eclipse E5-238</p>
<p>Columbia Boiler E5-207A</p>	<p>Dravo E5-232H</p>	<p>Eclipse E5-238B</p>
<p>Crane "A" none E5-213                  Crane 6" E5-214</p>	<p>Dravo E5-232I</p>	<p>Eclipse E5-239</p>
<p>Crane "A" none E5-213                  Crane 6" E5-214</p>	<p>Dravo E5-232J</p>	<p>Economite E5-239</p>
<p>Delco E5-221</p>	<p>Dravo E5-232L</p>	<p>Economite E5-239A</p>
<p>Delco E5-224</p>	<p>Dravo E5-232M</p>	<p>Economite E5-239B</p>

**Westwood** electrodes & insulators

HIGH DIELECTRIC STRENGTH • PRECISION DIMENSIONS

<p>Economite E5-239C</p>	<p>Fulton Boiler 12-1/4" E5-282A Fulton Boiler 17-1/4" E5-282B</p>	<p>Gordon Piatt 5" E5-307B Gordon Piatt 7" E5-307C Gordon Piatt 9" E5-307D</p>
<p>Economite E5-239D</p>	<p>Fulton Boiler E5-282C</p>	<p>Gordon Piatt 4" E5-307F Gordon Piatt 5" E5-307P Gordon Piatt 6" E5-307G Gordon Piatt 8" E5-307H</p>
<p>Economite E5-239E</p>	<p>Fulton Boiler E5-283A</p>	<p>Gordon Piatt 7-3/4" E5-307I Gordon Piatt 13-1/2" E5-307J</p>
<p>Economite E5-239F</p>	<p>Fulton Boiler E5-283B</p>	<p>Gordon Piatt E5-307K</p>
<p>Edison E5-246</p>	<p>Fulton Boiler E5-284</p>	<p>Gordon Piatt E5-307O</p>
<p>Edison E5-247</p>	<p>Fulton Boiler E5-285</p>	<p>Gordon Piatt E5-307Q Gordon Piatt 6" E5-307R Gordon Piatt 8" E5-307S</p>
<p>Electromagic E5-249A</p>	<p>General Automatic E5-290</p>	<p>Gordon Piatt E5-307U</p>
<p>Enterprise 5" E5-253B Enterprise 1-3/4" E5-253C Enterprise 2-1/2" E5-253D</p>	<p>General Electric E5-291</p>	<p>Gordon Piatt 4" E5-307Q Gordon Piatt 6" E5-307R Gordon Piatt 8" E5-307S</p>
<p>Esso E5-258</p>	<p>General Electric E5-296</p>	<p>Gordon Piatt E5-307V</p>
<p>Esso E5-261</p>	<p>General Electric E5-298</p>	<p>Gordon Piatt E5-307N Gordon Piatt 5" E5-307T</p>
<p>Flame Guard 3-9/16" 2-1/4" E5-267A Flame Guard 6" 4" E5-267B Flame Guard 11-7/16" 4" E5-267C Flame Guard 5" 4" E5-267E Flame Guard 4" 4" E5-267F Flame Guard 8" 4" E5-267G</p>	<p>General Electric E5-299A</p>	<p>Gordon Piatt E5-307N Gordon Piatt 5" E5-307T</p>
<p>Flame Guard E5-267D</p>	<p>General Electric E5-301A</p>	<p>Gordon Piatt E5-307W</p>
<p>Fulton Boiler 12-1/4" E5-282 Fulton Boiler 17-1/4" E5-283</p>	<p>General Electric E5-301B</p>	<p>Gould 5" E5-308 Gould 6" E5-309 Gould 7" E5-310 Gould 8" E5-311</p>
<p>Gold Star 4" E5-306 Gold Star 5" E5-307</p>	<p>Gould E5-308 Gould E5-309 Gould E5-310 Gould E5-311</p>	<p>Gould E5-308 Gould E5-309 Gould E5-310 Gould E5-311</p>



**Westwood** electrodes & insulators

HIGH DIELECTRIC STRENGTH • PRECISION DIMENSIONS

<p>Heil Heil "A" 2-1/4" 4" E5-330A E5-330B</p>	<p>International E5-348A</p>	<p>Iron Fireman E5-365D</p>
<p>Heil E5-331B</p>	<p>Iron Fireman E5-357</p>	<p>Iron Fireman E5-366D</p>
<p>Homelite E5-337A</p>	<p>Iron Fireman E5-357C</p>	<p>Johnson "A" 1-1/2" 2" 7-1/2" 6" E5-371 E5-371A E5-372 E5-374</p>
<p>Homestead E5-338</p>	<p>Iron Fireman E5-357D</p>	<p>Johnson E5-373</p>
<p>Homestead E5-340</p>	<p>Iron Fireman E5-357E</p>	<p>Johnson E5-373A</p>
<p>Homestead E5-341</p>	<p>Iron Fireman E5-357F</p>	<p>Johnson E5-375</p>
<p>Homestead E5-341A</p>	<p>Iron Fireman E5-357I</p>	<p>Johnson E5-375A</p>
<p>Industrial Combustion E5-342</p>	<p>Iron Fireman E5-357J</p>	<p>Johnson E5-377</p>
<p>Industrial Combustion E5-343</p>	<p>Iron Fireman E5-357L</p>	<p>Johnson Gas E5-377A</p>
<p>Industrial Combustion E5-343A</p>	<p>Iron Fireman E5-357M</p>	<p>Kewanee E5-378</p>
<p>Industrial Combustion E5-344</p>	<p>Iron Fireman E5-357O</p>	<p>Kewanee E5-378A</p>
<p>Industrial Combustion E5-344A</p>	<p>Iron Fireman E5-357R</p>	<p>Kewanee E5-378B</p>
<p>Industrial Combustion E5-345</p>	<p>Iron Fireman E5-357S</p>	<p>Kewanee E5-378A</p>
<p>Industrial Combustion E5-345A</p>	<p>Iron Fireman E5-357T</p>	<p>Kewanee E5-378C</p>
<p>International E5-348</p>	<p>Iron Fireman E5-357U</p>	<p>Lenan E5-379I</p>
<p>Iron Fireman E5-357V</p>	<p>La Salle E5-381</p>	

**Westwood** electrodes & insulators





HIGH DIELECTRIC STRENGTH • PRECISION DIMENSIONS

 Lennox (Bettendorf) E5-383	 Mettler E5-399A	 Miller E5-399F1
 Lennox (Bettendorf) E5-383A	 Mettler E5-399B	 Miller E5-400A
 Lennox (Bettendorf) E5-384	 Mettler E5-399C	 MSO Combustion E5-390
 Lennox (Bettendorf) LH/RH E5-384A	 Mid Continental E5-399G	 MSO Combustion E5-391
 Lennox "A" 2" E5-384C Lennox "A" 4" E5-384D Lennox "A" 6" E5-384E	 Mid Continental E5-399H	 Morrison E5-404
 Lisk Savory E5-384F	 Mid Continental E5-399I	 Mt Hawley RH/LH E5-406A
 Lynn E5-387	 Mid Continental E5-399J	 M&H E5-407
 Lynn E5-388	 Mid Continental E5-399K	 M&H E5-407A
 Lynn E5-388A	 Mid Continent E5-399M	 M&H E5-408
 Master Vibrator E5-392A	 Mid Continent E5-399N	 M&H E5-409
 Master Vibrator E5-392B	 Mid Continent E5-399O	 M&H E5-409A
 Master Vibrator E5-393	 Mid Continent E5-399P	 M&H E5-409B
 Messer E5-393A	 Mid Continent E5-399Q	 M&H E5-409C
 Mc Naulin E5-393D	 Mid Continent E5-399R	 M&H E5-409D
 Metal Master E5-395	 Mid Continental (MIDCO) E5-399S	 M&H (with Bracket) E5-409C-2
	 Miller E5-399F	

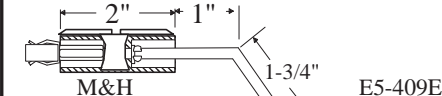
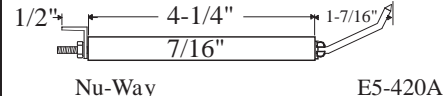
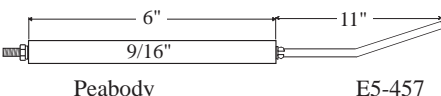
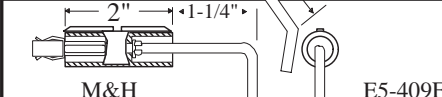
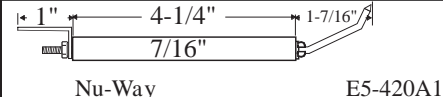
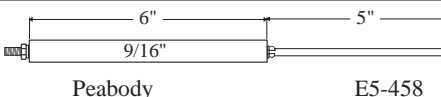
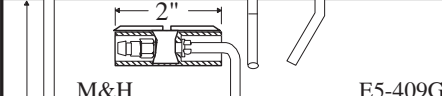
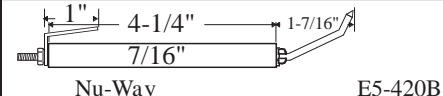
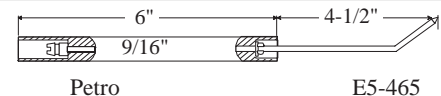
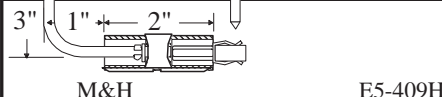
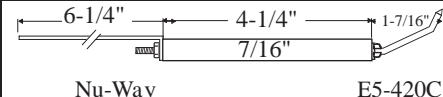
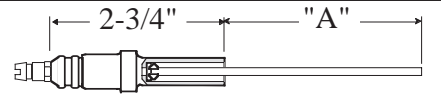
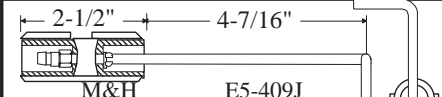
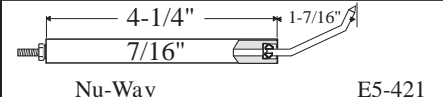
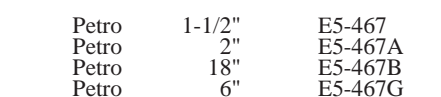
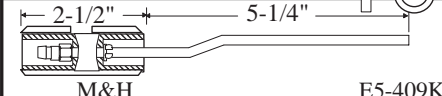
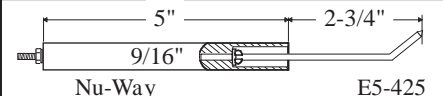
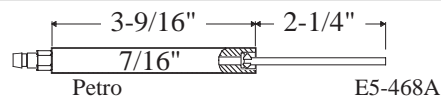
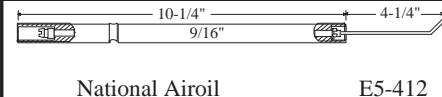
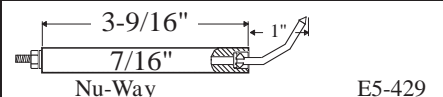
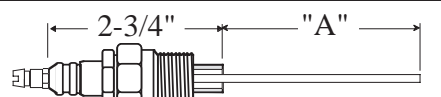

**Westwood** electrodes & insulators

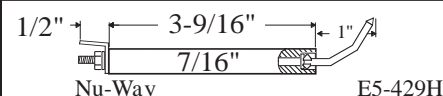
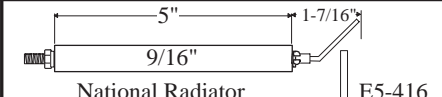
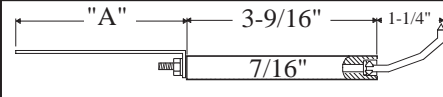
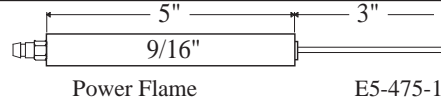
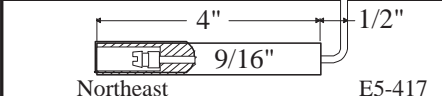
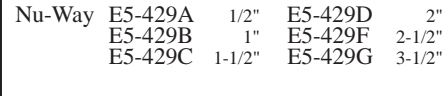
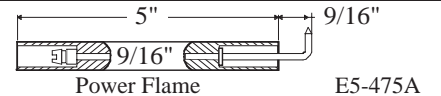
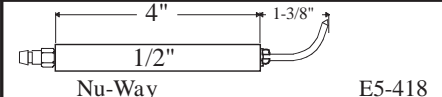
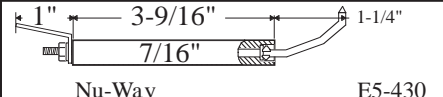
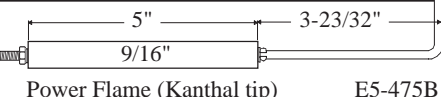
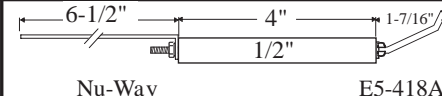
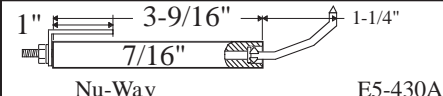
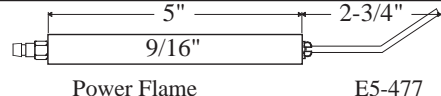
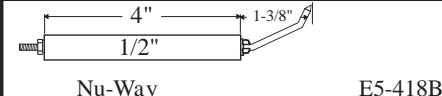
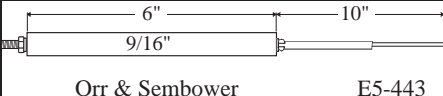
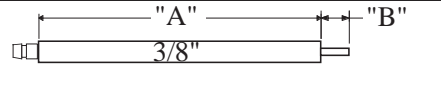
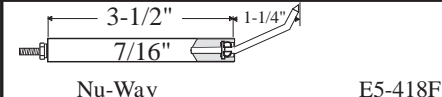
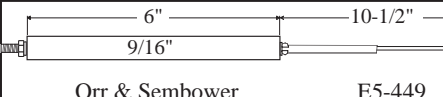
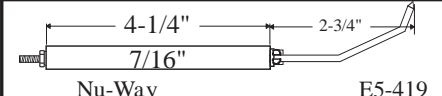
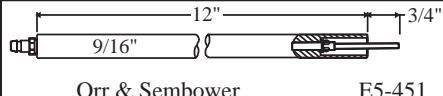
HIGH DIELECTRIC STRENGTH • PRECISION DIMENSIONS

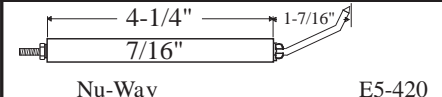
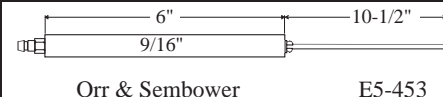
		
M&H E5-409E	Nu-Way E5-420A	Peabody E5-457
		
M&H E5-409F	Nu-Way E5-420A1	Peabody E5-458
		
M&H E5-409G	Nu-Way E5-420B	Petro E5-465
		
M&H E5-409H	Nu-Way E5-420C	Petro E5-467
		
M&H E5-409J	Nu-Way E5-421	Petro E5-467A Petro E5-467B Petro E5-467G
		
M&H E5-409K	Nu-Way E5-425	Petro E5-468A
		
National Airoil E5-412	Nu-Way E5-429	Petro E5-468B Petro E5-468C Petro E5-468D
		
National Airoil E5-415	Nu-Way E5-429H	
		
National Radiator E5-416	Nu-Way E5-429A	Power Flame E5-475-1
		
Northeast E5-417	Nu-Way E5-429B	Power Flame E5-475A
		
Nu-Way E5-418	Nu-Way E5-429C	Power Flame (Kanthal tip) E5-475B
		
Nu-Way E5-418A	Nu-Way E5-430	Power Flame E5-477
		
Nu-Way E5-418B	Orr & Sembower E5-443	Power Flame E5-477A Power Flame E5-477B Power Flame E5-477C
		
Nu-Way E5-418F	Orr & Sembower E5-449	
		
Nu-Way E5-419	Orr & Sembower E5-451	Power Flame E5-477A-1 Power Flame E5-477B-1 Power Flame E5-477C-1
		
Nu-Way E5-420	Orr & Sembower E5-453	

**Westwood** electrodes & insulators

HIGH DIELECTRIC STRENGTH • PRECISION DIMENSIONS

<p>Power Flame E5-477D</p>	<p>Power Flame E5-479B</p>	<p>Ray E5-500</p>
<p>Power Flame E5-477E</p>	<p>Power Flame E5-479C</p>	<p>Ray E5-502</p>
<p>Power Flame E5-477F</p>	<p>Power Flame E5-479D</p>	<p>Ray E5-503A</p>
<p>Power Flame (Stainless tip) E5-477G</p>	<p>Power Flame E5-479E</p>	<p>Ray E5-503D</p>
<p>Power Flame E5-477H</p>	<p>Power Flame E5-479E1</p>	<p>Ray E5-503E</p>
<p>Power Flame E5-477I</p>	<p>Preferred Utilities E5-471A</p>	<p>Ray E5-503G</p>
<p>Power Flame E5-477J</p>	<p>PVI E5-473F</p>	<p>Ray E5-503H</p>
<p>Power Flame E5-477K</p>	<p>PVI E5-473G</p>	<p>Ray E5-503J</p>
<p>Power Flame E5-478</p>	<p>Pyronics E5-474C-1 6" E5-474C-2 12"</p>	<p>Ray E5-503M</p>
<p>Power Flame E5-478A</p>	<p>Pyronics E5-474E</p>	<p>Ray E5-503P</p>
<p>Power Flame E5-478B</p>		<p>Robert Gordon E5-506B</p>
<p>Power Flame E5-478C</p>	<p>Quiet Heat 4-1/4" E5-483                  Quiet Heat 5" E5-483-5                  Quiet Heat 6" E5-483-6</p>	<p>Robert Gordon E5-506C</p>
<p>Power Flame E5-478D</p>	<p>Radiant E5-490</p>	<p>Light Tip</p> <p>Shellhead 4" E5-513-4                  Shellhead 5" E5-513-5                  Shellhead 6" E5-513-6                  Shellhead 7" E5-513-7                  Shellhead 8" E5-513-8                  Shellhead 9" E5-513-9                  Shellhead 10" E5-513-10                  Shellhead 11" E5-513-11                  Shellhead 12" E5-513-12                  Shellhead 13" E5-513-13                  Shellhead 14" E5-513-14</p>
<p>Power Flame E5-478E</p>	<p>Rails E5-489B</p>	
<p>Power Flame E5-479</p>	<p>Rails E5-489C</p>	
<p>Power Flame E5-479A</p>	<p>Ray E5-499 3-3/4" E5-499C 5"</p>	



Please order by No.

rev. 3-9-17

**E10**



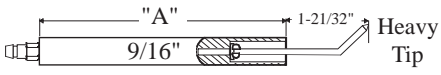
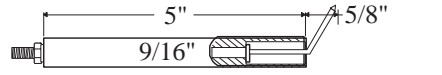
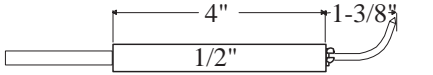
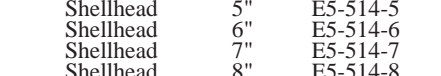
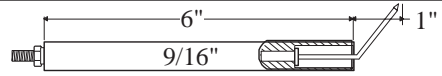
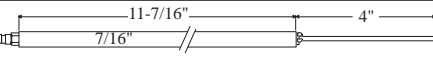
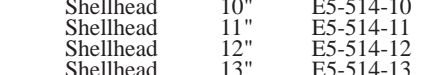
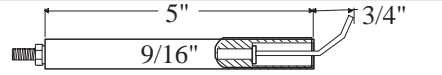
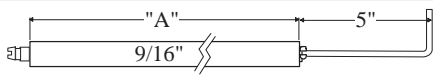
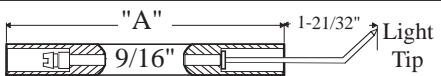
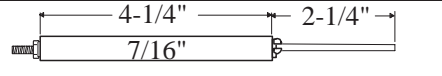
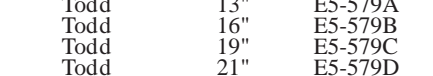
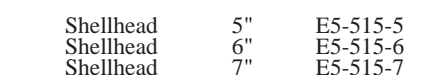
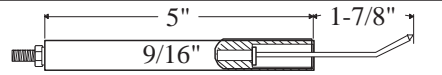
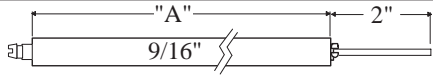
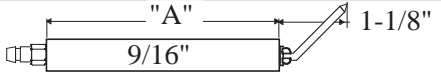
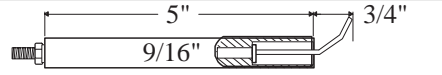
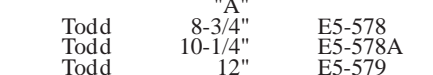

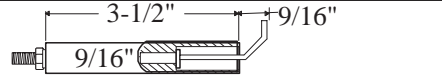
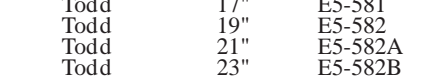
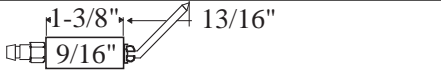
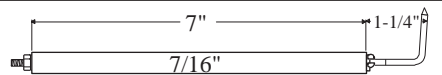
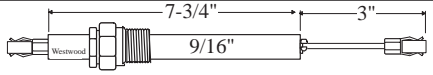
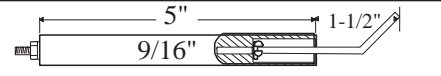
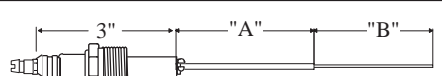
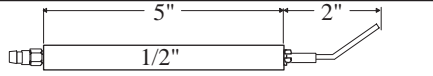
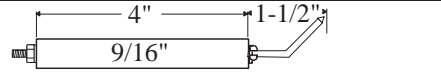
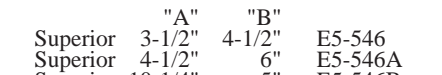
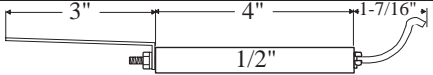
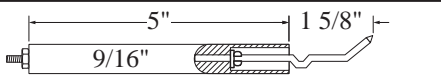
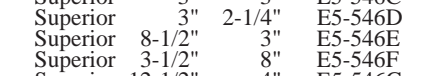
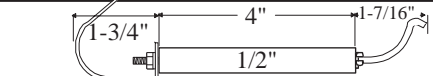
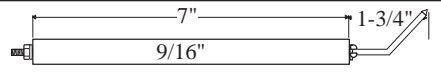
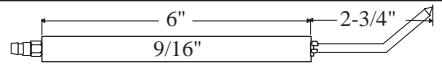
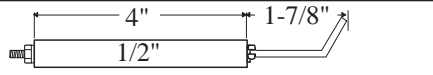
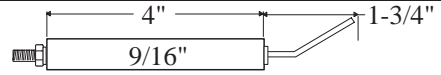
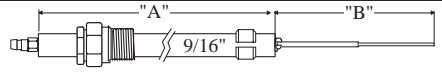
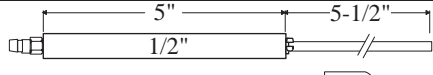
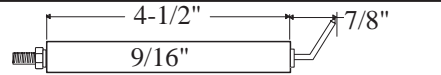
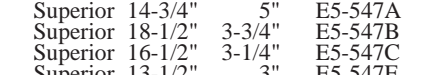
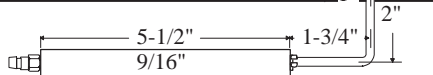

**Westwood** electrodes & insulators

HIGH DIELECTRIC STRENGTH • PRECISION DIMENSIONS

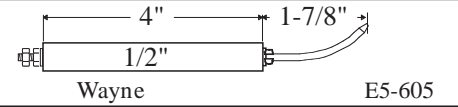
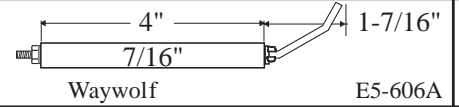
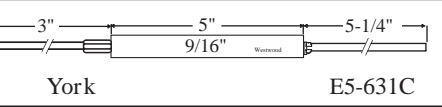
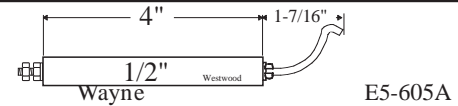
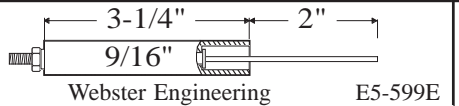
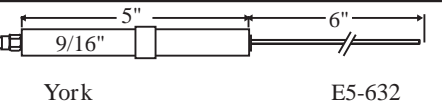
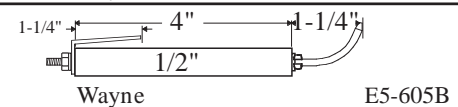
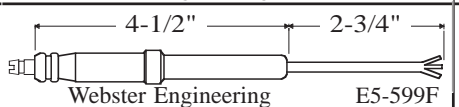
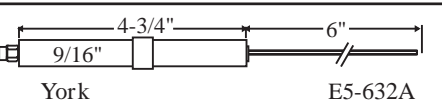
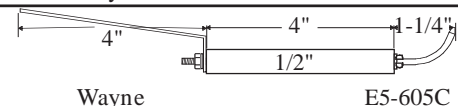
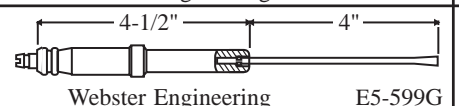
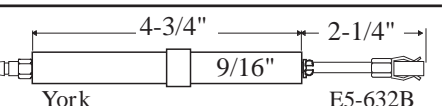
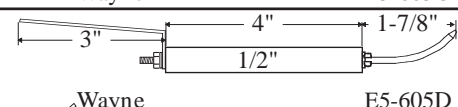
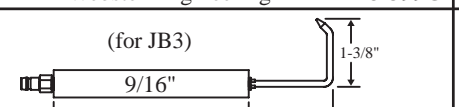
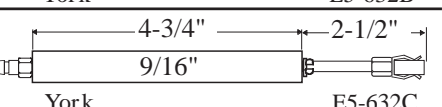
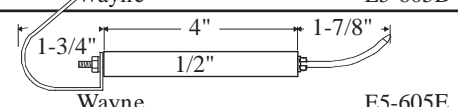
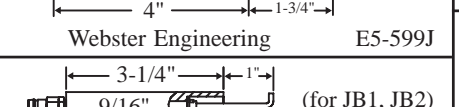
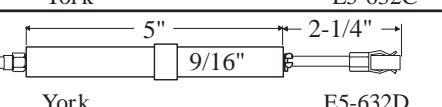
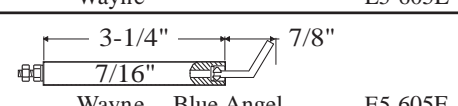
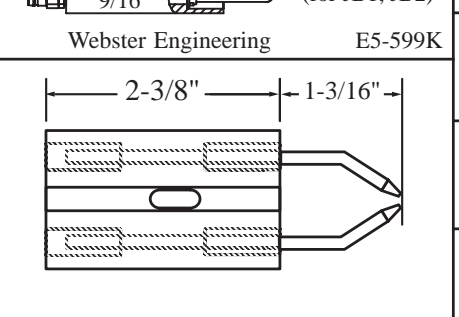
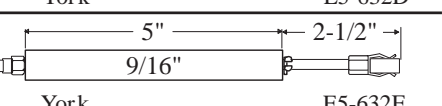
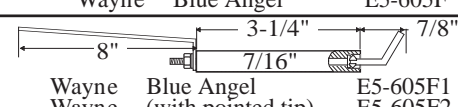
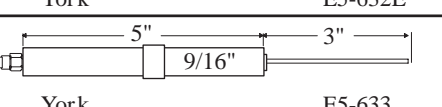
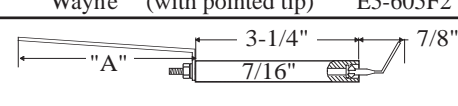
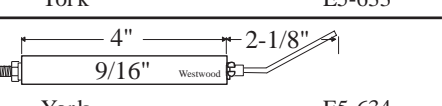
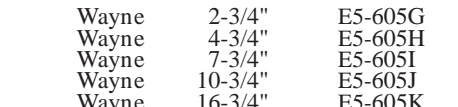
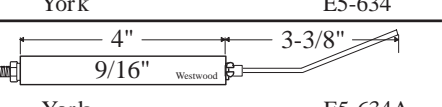
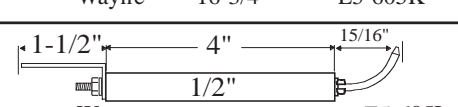
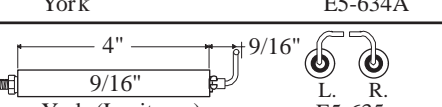
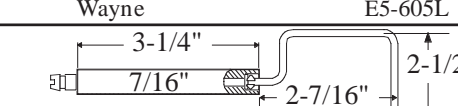
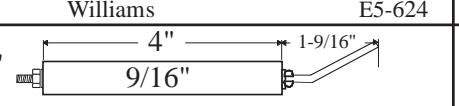
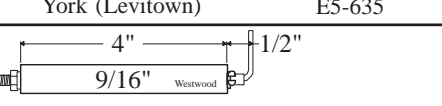
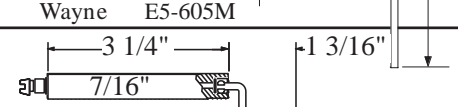
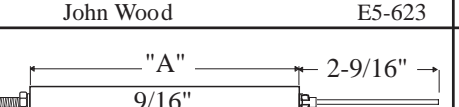
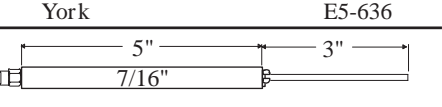
 <p>Shellhead 4" E5-514-4                  Shellhead 5" E5-514-5                  Shellhead 6" E5-514-6                  Shellhead 7" E5-514-7                  Shellhead 8" E5-514-8                  Shellhead 9" E5-514-9                  Shellhead 10" E5-514-10                  Shellhead 11" E5-514-11                  Shellhead 12" E5-514-12                  Shellhead 13" E5-514-13                  Shellhead 14" E5-514-14</p>	 <p>Sun Ray E5-559E</p>	 <p>Thatcher E5-560</p>
 <p>Sun Ray E5-559F</p>	 <p>Todd E5-577A</p>	 <p>Todd 13" E5-579A                  Todd 16" E5-579B                  Todd 19" E5-579C                  Todd 21" E5-579D                  Todd 22" E5-579E</p>
 <p>Sun Ray E5-559H</p>	 <p>Sun Ray E5-559J</p>	 <p>Todd 8-3/4" E5-578                  Todd 10-1/4" E5-578A                  Todd 12" E5-579                  Todd 14" E5-580                  Todd 17" E5-581                  Todd 19" E5-582                  Todd 21" E5-582A                  Todd 23" E5-582B                  Todd 24" E5-582C</p>
 <p>Shellhead 5" E5-515-5                  Shellhead 6" E5-515-6                  Shellhead 7" E5-515-7                  Shellhead 8" E5-515-8</p>	 <p>Sun Ray E5-559K</p>	 <p>Sun Ray E5-559L</p>
 <p>Silent Glow 3" E5-523                  Silent Glow 4" E5-524                  Silent Glow 5" E5-525                  Silent Glow 6" E5-526                  Silent Glow 11-3/4" E5-527</p>	 <p>Sun Ray E5-559M</p>	 <p>Sun Ray E5-559N</p>
 <p>Silent Glow E5-523A</p>	 <p>Stewart Warner E5-545</p>	 <p>Tornado Todd E5-588B</p>
 <p>Sun Ray E5-550</p>	 <p>Superior "A" "B"                  Superior 3-1/2" 4-1/2" E5-546                  Superior 4-1/2" 6" E5-546A                  Superior 10-1/4" 5" E5-546B                  Superior 3" 3" E5-546C                  Superior 3" 2-1/4" E5-546D                  Superior 8-1/2" 3" E5-546E                  Superior 3-1/2" 8" E5-546F                  Superior 12-1/2" 4" E5-546G</p>	 <p>Volcano E5-590</p>
 <p>Sun Ray E5-553</p>	 <p>Sun Ray E5-557</p>	 <p>Wayne E5-601A</p>
 <p>Sun Ray E5-558</p>	 <p>Sun Ray E5-559B</p>	 <p>Wayne E5-601B</p>
 <p>Sun Ray E5-559</p>	 <p>Superior "A" "B"                  Superior 14-3/4" 5" E5-547A                  Superior 18-1/2" 3-3/4" E5-547B                  Superior 16-1/2" 3-1/4" E5-547C                  Superior 13-1/2" 3" E5-547E</p>	 <p>Wayne E5-604A</p>
 <p>Sun Ray E5-559B</p>	 <p>Superior E5-547</p>	 <p>Wayne E5-604</p>
 <p>Sun Ray E5-559D</p>	 <p>Superior E5-547F</p>	 <p>Wayne E5-604B</p>
 <p>Sun Ray E5-559B</p>	 <p>Superior Bulkhead E5-547D</p>	 <p>Wayne E5-604C</p>
 <p>Sun Ray E5-559D</p>	 <p>Superior E5-547F</p>	 <p>Wayne E5-604D</p>

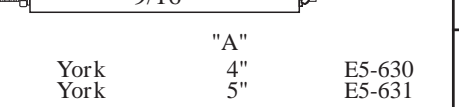
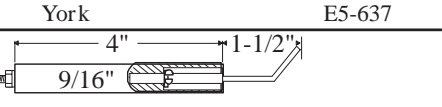
**Westwood** electrodes & insulators

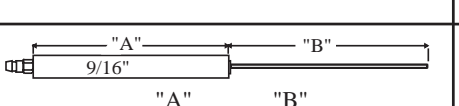
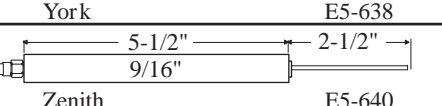
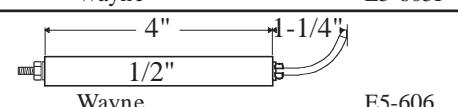
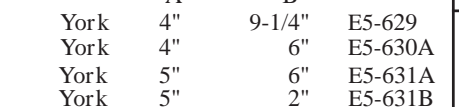
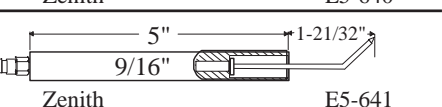
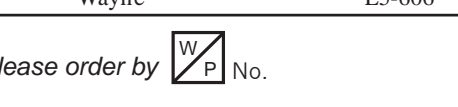
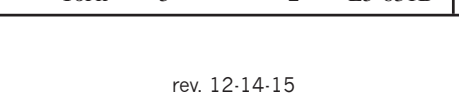
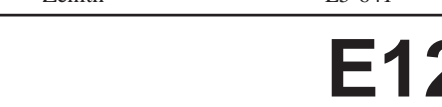
HIGH DIELECTRIC STRENGTH • PRECISION DIMENSIONS

 Wayne E5-605	 Waywolf E5-606A	 York E5-631C
 Wayne E5-605A	 Webster Engineering E5-599E	 York E5-632
 Wayne E5-605B	 Webster Engineering E5-599F	 York E5-632A
 Wayne E5-605C	 Webster Engineering E5-599G	 York E5-632B
 Wayne E5-605D	 (for JB3) Webster Engineering E5-599J	 York E5-632C
 Wayne E5-605E	 (for JB1, JB2) Webster Engineering E5-599K	 York E5-632D
 Wayne Blue Angel E5-605F	 Weil-McLain, electrode only E5-598 Weil-McLain electrode w/leads E5-598A Leads only (former WMK-150) E5-598B	 York E5-632E
 Wayne Blue Angel E5-605F1		 York E5-633
 Wayne Blue Angel (with pointed tip) E5-605F2		 York E5-634
 Wayne E5-605G		 York E5-634A
 Wayne E5-605H		 York E5-635
 Wayne E5-605I	 Williams E5-624	 York (Levittown) E5-636
 Wayne E5-605J	 John Wood E5-623	 York E5-637
 Wayne E5-605K	 York E5-630	 York E5-631
 Wayne E5-605L	 York E5-631A	 York E5-638
 Wayne E5-605M	 York E5-631B	 Zenith E5-640
 Wayne E5-605N	 York E5-629	 Zenith E5-641
 Wayne E5-605P	 York E5-630A	
 Wayne E5-606	 York E5-631A	

Please order by  No.

rev. 12-14-15

**E12**

Westwood

**ELECTRODE KITS**

FOR THE SERVICE PROFESSIONAL

**ELECTRODE & INSULATOR KITS****Serviceman's Deluxe Kit****OEM Electrodes - 2 ea.**

ABC: E5-146

Beckett: E5-151E, E5-1510

Carlin: E5-188B, E5-188N, E5-188K

Quiet Heet: E5-483

Wayne: E5-604, E5-605, E5-605B,  
E5-605F, E5-606**Rajah™ Terminals - 10 ea.**

E9-CT, E9-SS, E9-R-2, E9-RAC, E9-SF,

E9-BS 6-32, E9-BS 10-32,

E9-HS 6-32 (5 ea.), E9-HS 10-32 (5 ea.),  
6-32 nut, 10-32 nut**Standard Electrodes - 2 ea.**E5-1M4, E5-2M4, E5-2M5, E5-2M6,  
E5-4M4, E5-3M4, E5-3M5, E5-3M6**Also includes**

5 feet of GTO-15 ignition cable

1 set (2) T100-230 electrode benders

1 - T100-220 electrode gauge

1 set (2) T100-70 jumpers

1 - NAS gauge™ nozzle gauge

1 - Coupler Popper™ tool

1 - Plastic carrying case

 No. E5-2001
**Serviceman's Super Kits**

Same contents as the E5-2001 Deluxe Kit, less the NAS gauge™ and Coupler Popper™  
in a plastic carrying case

 No. E5-1897

Same contents as the E5-2001 Deluxe Kit, less the NAS gauge™ and Coupler Popper™  
in a cardboard box

 No. E5-1897-C
**ELECTRODE & INSULATOR ROLL-UP KITS****Contains:****Electrodes - 2 ea.**

E5-3M4 (9/16"x4"), E5-3M5 (9/16"x5"),

E5-3M6 (9/16"x6"), E5-3F5 (9/16"x5"),

E5-483 (Quiet Heet)

**Insulators - 2 ea.**

E5-1M4-1/4 (7/16"x4-1/4"), E5-4M4 (1/2"x4"),

E5-2M4 (9/16"x4"), E5-2M5 (9/16"x5"),

E5-3M4 (9/16"x4")

 No. E5-595
**Contains:****Electrodes - 2 ea.**

E5-188N (Carlin), E5-151E (Beckett),

E5-605 (Wayne), E5-2M4 (9/16"x4"),

E5-2M5 (9/16"x5"), E5-2M6 (9/16"x6"),

E5-2F5 (female 5"), E5-2F6 (female 6")

**Insulators - 2 ea.**

E5-1M4-1/4 (7/16"x4-1/4"), E5-3M4 (9/16"x4"),

E5-2M4 (9/16"x4"), E5-2M5 (9/16"x5"),

E5-2M6 (9/16"x6"), E5-2F5 (female 5"),

E5-2F6 (female 6"), E5-4M4 (1/2"x4")

 No. E5-920



Westwood

**ELECTRODE KITS**

FOR THE SERVICE PROFESSIONAL

**ELECTRODE & INSULATOR ROLL-UP KITS (Continued)**

For Servicing  
**Beckett Burners**

Contains these electrodes:

4 · E5-151E	2 · E5-151D
2 · E5-151E1	2 · E5-151R
2 · E5-151O	2 · E5-151G
2 · E5-151F	2 · E5-151J
2 · E5-151	



 No. E5-BK-400

For Servicing  
**Carlin Burners**

Contains these electrodes:

4 · E5-188N	2 · E5-188P
4 · E5-188B	2 · E5-188Q
2 · E5-188K	2 · E5-188R3
2 · E5-188R-2	2 · E5-188N4
2 · E5-188H	



 No. E5-CK-300

For Servicing  
**Wayne Burners**

Contains these electrodes:

4 · E5-605	2 · E5-605E
4 · E5-606	2 · E5-605C
2 · E5-605B	2 · E5-605D
2 · E5-605F	2 · E5-605F1
2 · E5-604	



 No. E5-WK-500

 Take a look . . .

PORCELAIN CUTTER No. T100-370 on page T17  
&  
RAJAH TERMINAL KITS on page E28

Please order by  No.

rev. 6-13-18

**E14**



Westwood  
**AUBURN IGNITION PRODUCTS**  
 IGNITORS • FLAME RODS • LIQUID LEVEL ELECTRODES



**NOTE: Auburn ignition products part numbers are now "E5-" followed by the former number.**

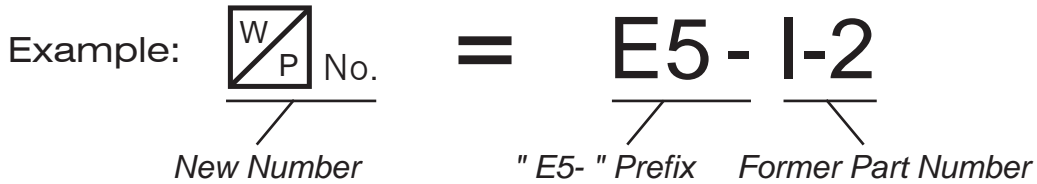

**149T-1 (.090)**

No.	Ref. No.
<b>E5-149T-1-090</b>	149T-1-090

**I-2-EI-2**

No.	Ref. No.
<b>E5-I-2-EI-2</b>	I-2-EI-2

**F-68**

No.	Ref. No.
<b>E5-F-68</b>	F-68

**I-2 Series**

No.	Ref. No.	"A" DIM.	"B" DIM.
<b>E5-I-2</b>	I-2	8.00	4.50
<b>E5-I-2-1</b>	I-2-1	15.50	12.00
<b>E5-I-2-2</b>	I-2-2	27.50	24.00

**F-140**

No.	Ref. No.
<b>E5-F-140</b>	

New!

\* Dimensions marked with an asterisk are standard lengths - Other lengths available upon request

**AUBURN ELECTRODES**

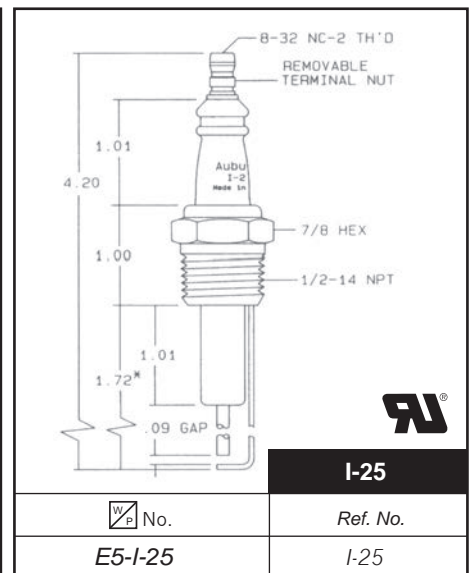
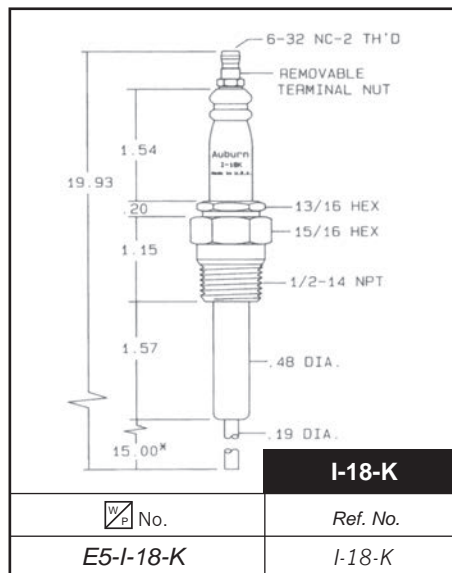
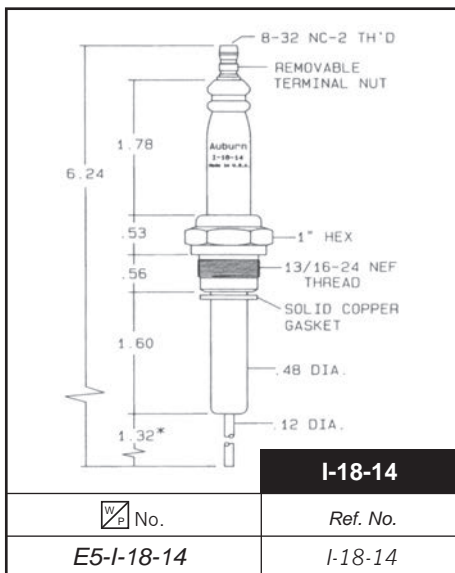
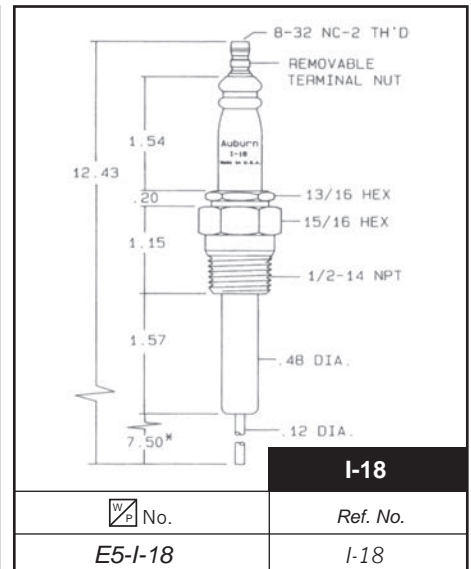
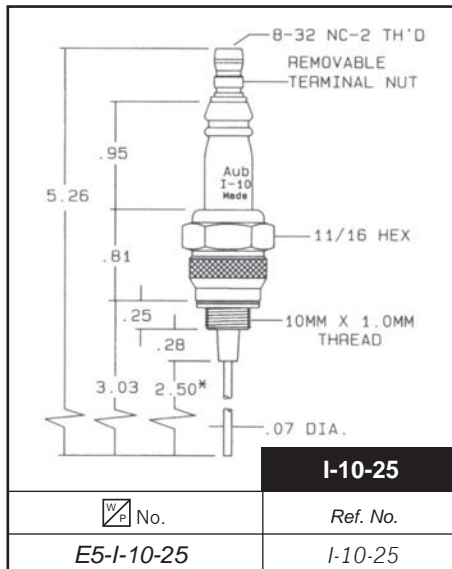
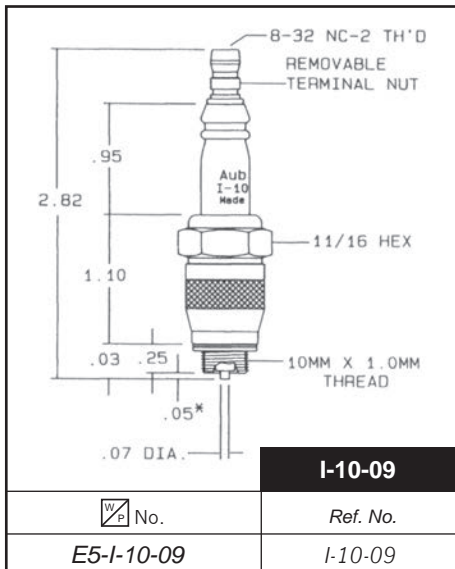
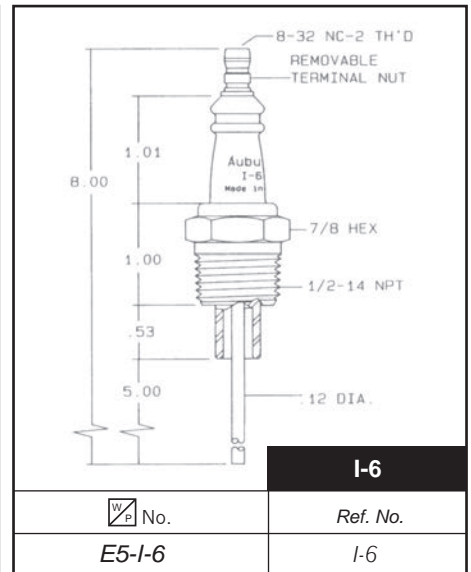
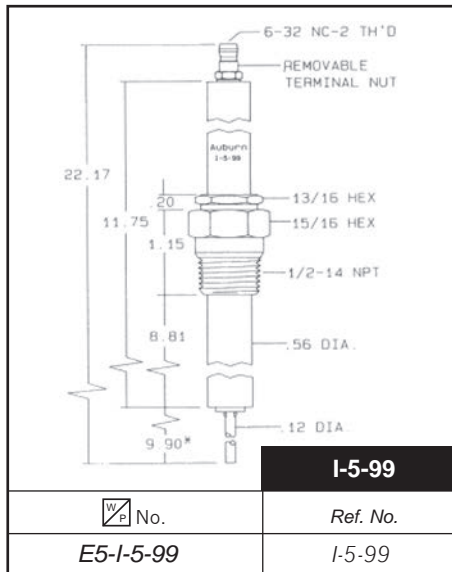
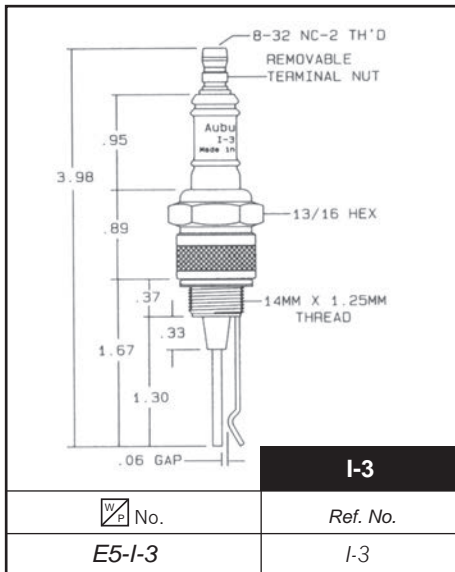

\* Dimensions marked with an asterisk are standard lengths - Other lengths available upon request

Please order by No.

rev. 12-14-15

**E16**

**AUBURN ELECTRODES**

**I-25-3**

W/P No.	Ref. No.
E5-I-25-3	I-25-3

**I-28**

W/P No.	Ref. No.
E5-I-28	I-28

**I-31 Series**

W/P No.	Ref. No.	"A"	"B"	ELEC. MAT.
E5-I-31	I-31	3.68	1.37	NICKEL
E5-I-31-1	I-31-1	4.17	1.87	NICKEL
E5-I-31-2	I-31-2	4.81	2.50	NICKEL
E5-I-31-3	I-31-3	4.17	1.87	INCONEL
E5-I-31-5	I-31-5	6.43	4.12	NICKEL
E5-I-31-6	I-31-6	3.31	1.06	NICKEL

**I-32** **E5-FI21501**

W/P No.	Ref. No.
E5-I-32 discontinued	I-32
E5-FI21501	FI21501

**I-33**

W/P No.	Ref. No.
E5-I-33	I-33

**I-64 Series**

W/P No.	Ref. No.	"A"	"B"	GAP	ELEC. MAT.
E5-I-64-1	I-64-1	4.20	1.72	.090	NI
E5-I-64-3	I-64-3	6.24	3.75	.090	NI
E5-I-64-4	I-64-4	3.60	1.12	.100	NI

**I-75-5**

W/P No.	Ref. No.
E5-I-75-5	I-75-5

**I-75-6**

W/P No.	Ref. No.
E5-I-75-6	I-75-6

**I-82**

W/P No.	Ref. No.
E5-I-82	I-82

\* Dimensions marked with an asterisk are standard lengths - Other lengths available upon request

**AUBURN ELECTRODES**

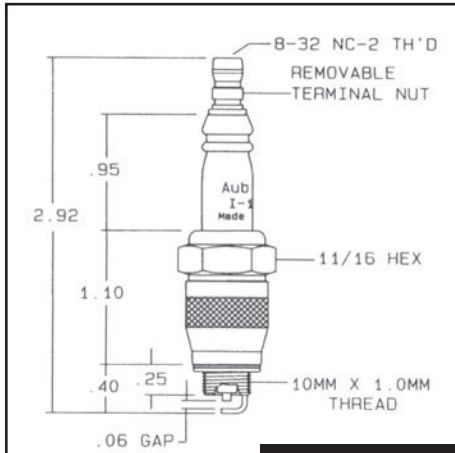

**I-101**

No.	Ref. No.
E5-I-101	I-101

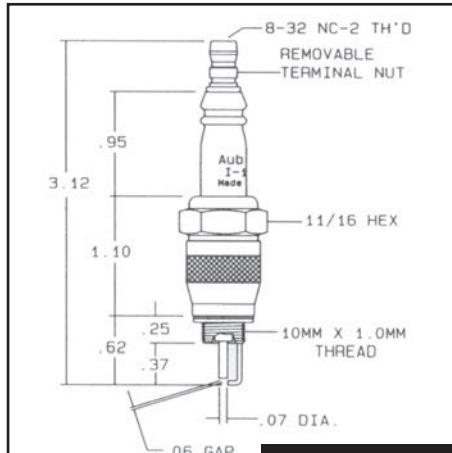

**I-102**

No.	Ref. No.
E5-I-102	I-102

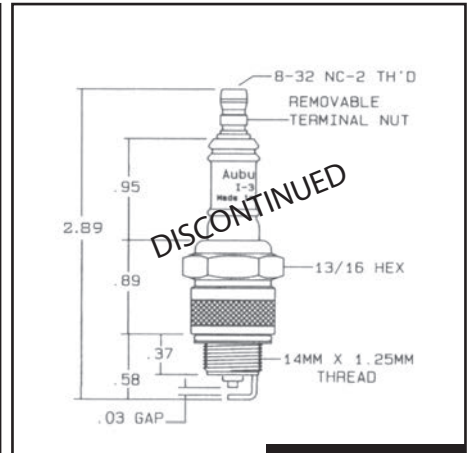

**I-141**

No.	Ref. No.
E5-I-141	I-141

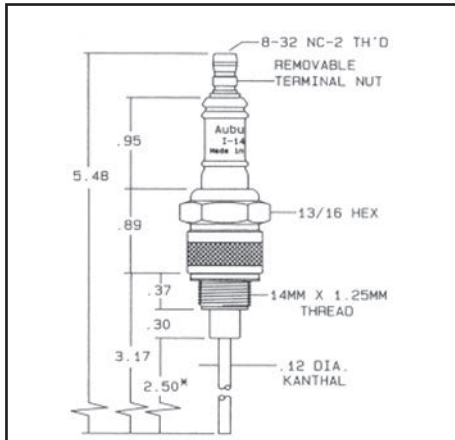

**I-143**

No.	Ref. No.
E5-I-143	I-143

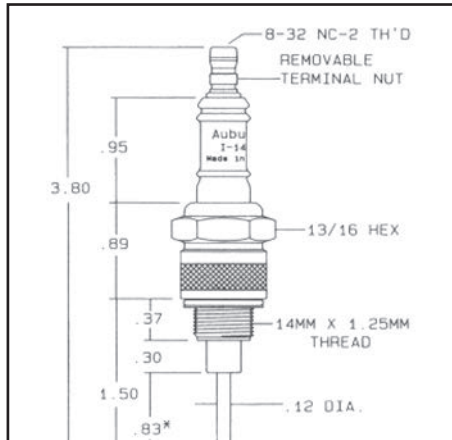

**I-144**

No.	Ref. No.
E5-I-144	I-144

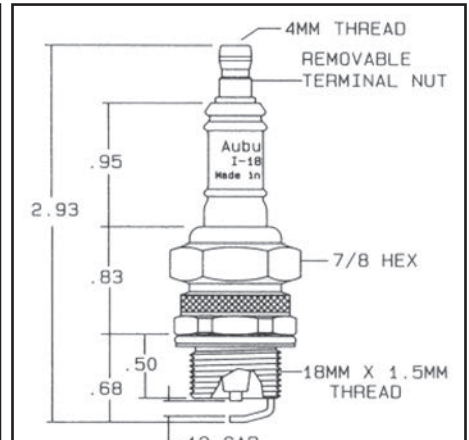

**I-181**

No.	Ref. No.
E5-I-181	I-181

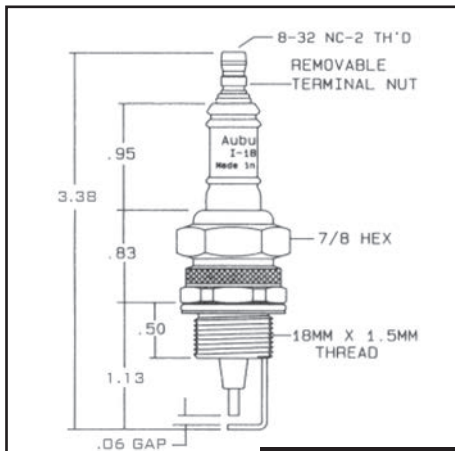

**I-182**

No.	Ref. No.
E5-I-182	I-182

As a major distributor of Auburn Ignition Products, Westwood can special order any Auburn item not shown in this catalog and get it to you fast!

\* Dimensions marked with an asterisk are standard lengths - Other lengths available upon request

**AUBURN ELECTRODES**

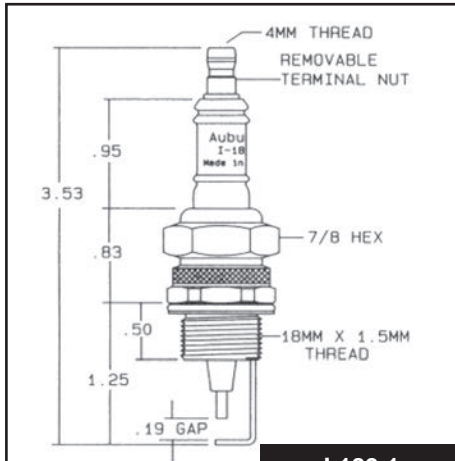

**I-182-1**

No.	Ref. No.
E5-I-182-1	I-182-1

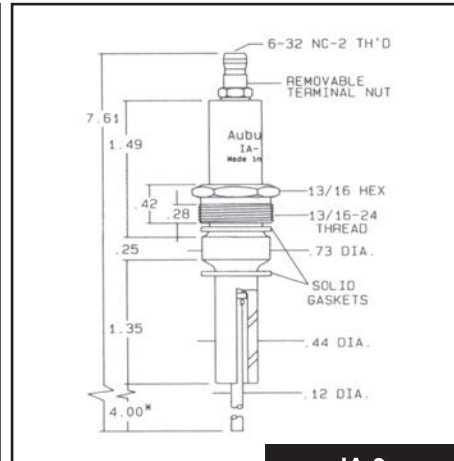

**IA-9**

No.	Ref. No.
E5-IA-9	IA-9

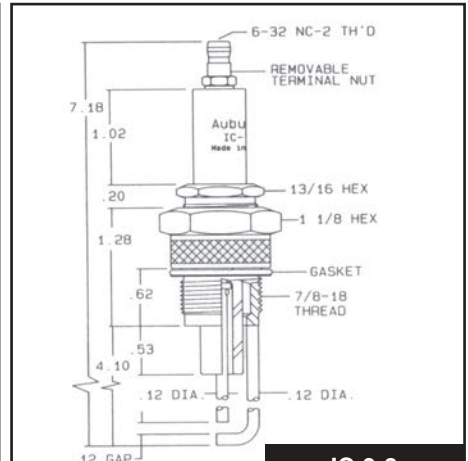

**IC-9-2**

No.	Ref. No.
E5-IC9-2	IC9-2

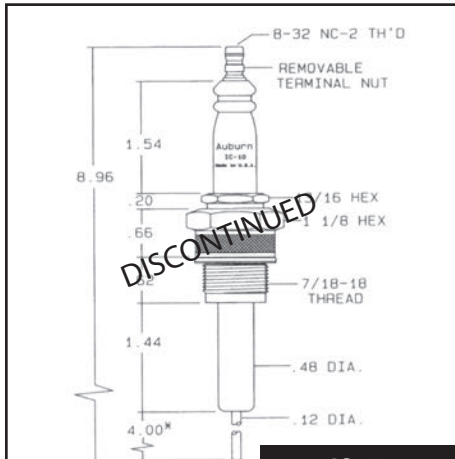

**IC-10**

No.	Ref. No.
E5-IC-10	IC-10

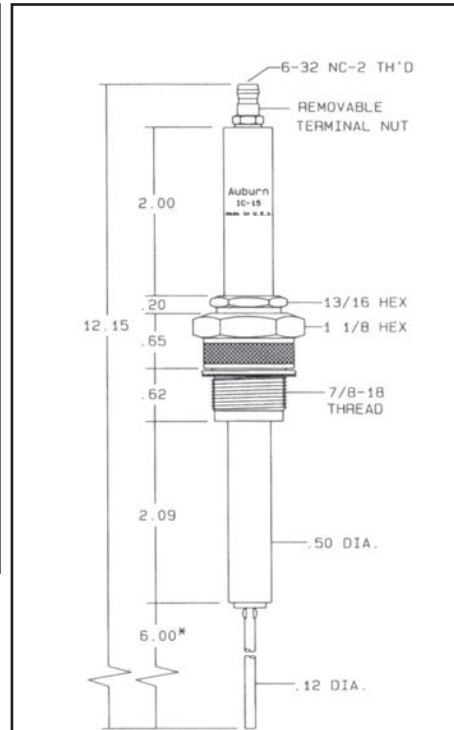

**IC-15**

No.	Ref. No.
E5-IC-15	IC-15

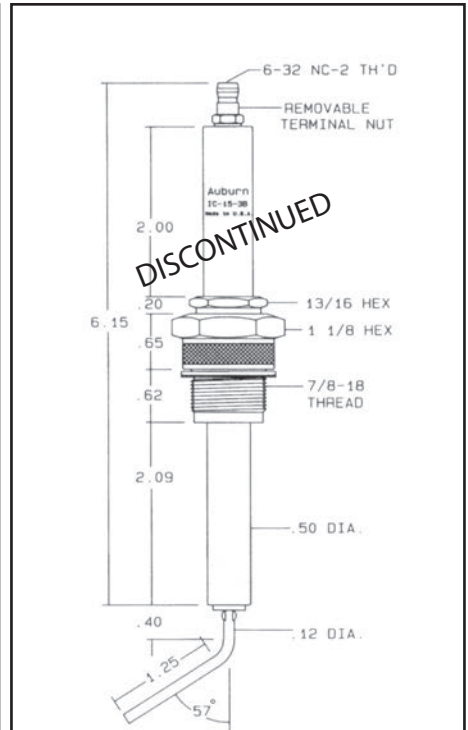

CHROMEL "D"  
Center Wire

**IC-15-3B**

No.	Ref. No.
E5-IC-15-3B	IC-15-3B

As a major distributor of Auburn Ignition Products, Westwood can special order any Auburn item not shown in this catalog and get it to you fast!

\* Dimensions marked with an asterisk are standard lengths - Other lengths available upon request



### AUBURN ELECTRODES

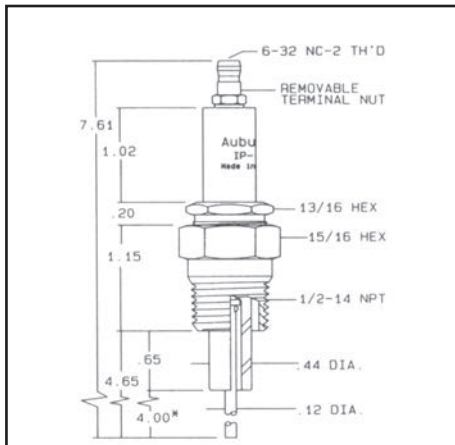

**IP-9**

No.	Ref. No.
E5-IP-9	IP-9

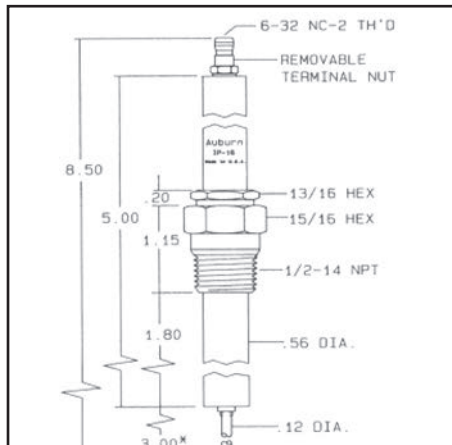

**IP-16**

No.	Ref. No.
E5-IP-16	IP-16

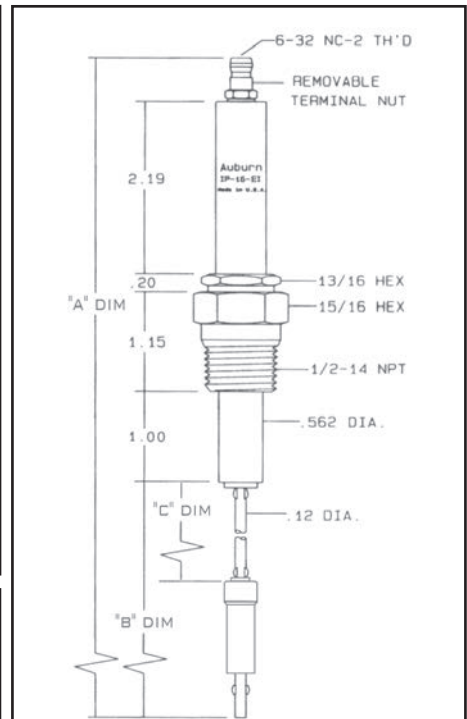

**IP-16-EI Series**

No.	Ref. No.	"A"	"B"	"C"
E5-IP-16-EI	IP-16-EI	18.75	13.25	11.25

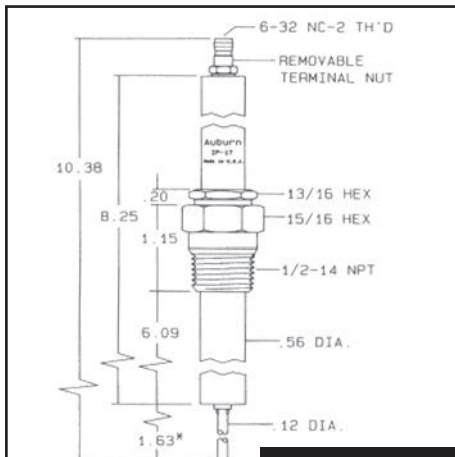

**IP-17**

No.	Ref. No.
E5-IP-17	IP-17

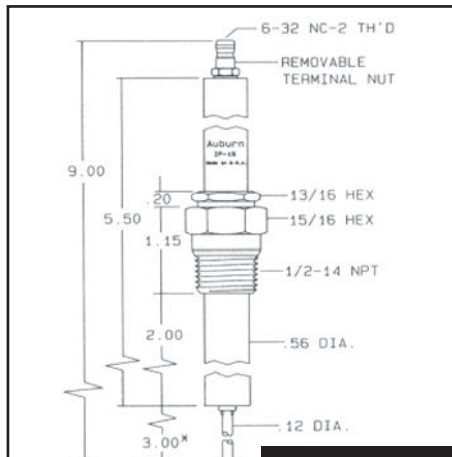

**IP-19**

No.	Ref. No.
E5-IP-19	IP-19

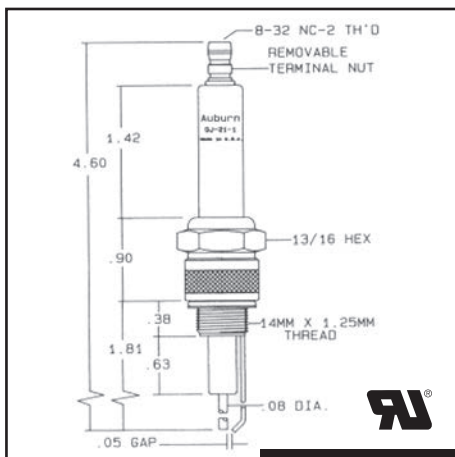

**OJ-21-1**

No.	Ref. No.
E5-OJ-21-1	OJ-21-1

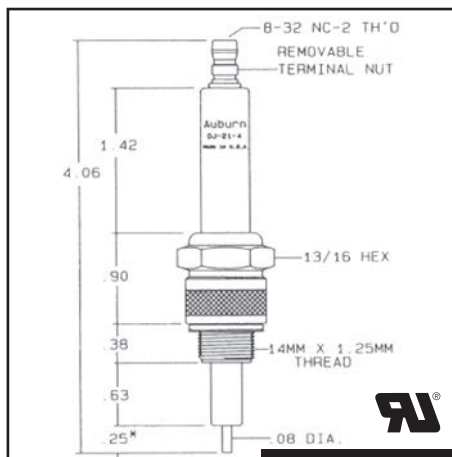

**OJ-21-4**

No.	Ref. No.
E5-OJ-21-4	OJ-21-4

As a major distributor of Auburn Ignition Products, Westwood can special order any Auburn item not shown in this catalog and get it to you fast!

\* Dimensions marked with an asterisk are standard lengths - Other lengths available upon request



**AUBURN ELECTRODES & FLAME RODS**

**OJ-21-5**

W/P No.	Ref. No.
E5-OJ-21-5	OJ-21-5

**FLAME ROD FRS-2 Series**

Center electrode tip operating temp 2,350° F

W/P No.	Ref. No.	"A" DIM.
E5-FRS-2-6	FRS-2-6	6"
E5-FRS-2-12	FRS-2-12	12"
E5-FRS-2-18	FRS-2-18	18"
E5-FRS-2-24	FRS-2-24	24"

**FLAME ROD FRS-4 Series**

Center electrode tip operating temp 2,350° F

W/P No.	Ref. No.	"A" DIM.
E5-FRS-4-4	FRS-4-4	4"
E5-FRS-4-6	FRS-4-6	6"
E5-FRS-4-7-1/2	FRS-4-7-1/2	7-1/2"
E5-FRS-4-12	FRS-4-12	12"
E5-FRS-4-24	FRS-4-24	24"

**FLAME ROD FRS-3**

W/P No.	Ref. No.
E5-FRS-3	FRS-3

As a major distributor of Auburn Ignition Products, Westwood can special order any Auburn item not shown in this catalog and get it to you fast!

\* Dimensions marked with an asterisk are standard lengths - Other lengths available upon request

## AUBURN LIQUID LEVEL ELECTRODES

### WCC Series:

Metal parts are 303 or 304 non-magnetic stainless steel. Incorporates an internal conductive glass seal (not recommended for use above 450 volts). Non-steam applications up to 2,500 PSI at 120° F or 0 PSI at 700° F. Steam applications up to 250 PSI at 406° F

### WCC-KH Series:

Metal parts are 303 or 304 non-magnetic stainless steel. Incorporates a special insulator tip seal and Kovar center wire-glass seal. Non-steam applications up to 2,500 PSI at 120° F or 0 PSI at 450° F. Steam applications up to 450 PSI at 459° F

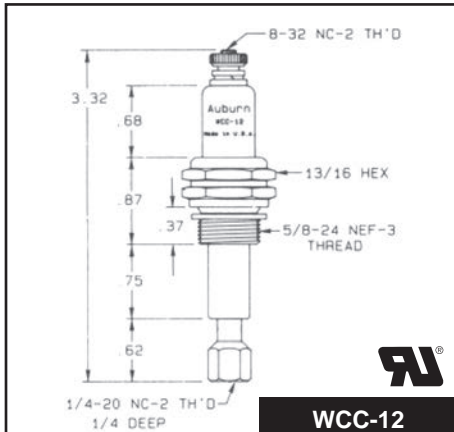

**WCC-12**

No.	Ref. No.
E5-WCC-12	WCC-12

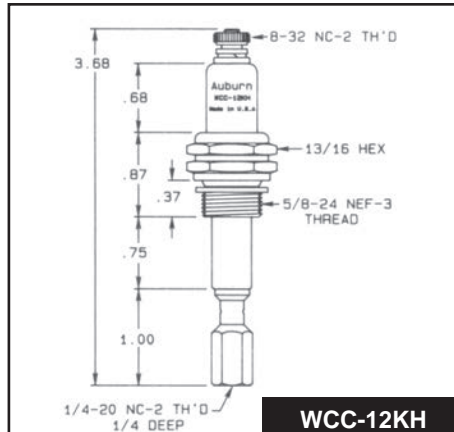

**WCC-12KH**

No.	Ref. No.
E5-WCC-12KH	WCC-12KH

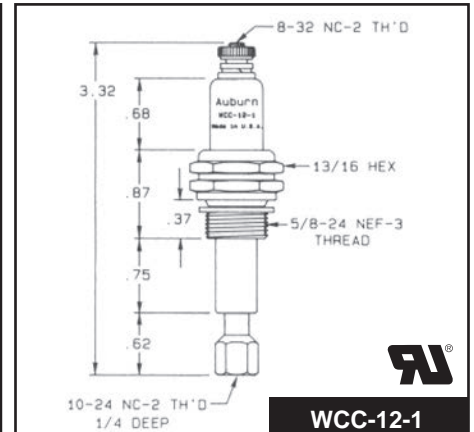

**WCC-12-1**

No.	Ref. No.
E5-WCC-12-1	WCC-12-1

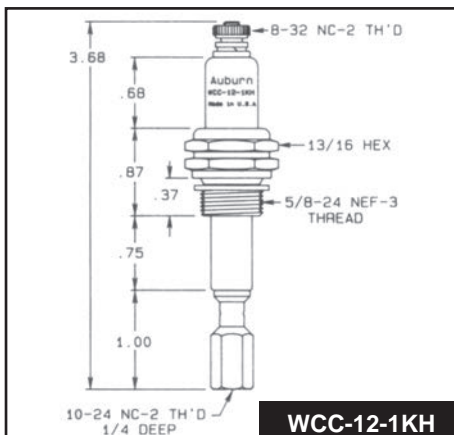

**WCC-12-1KH**

No.	Ref. No.
E5-WCC-12-1KH	WCC-12-1KH

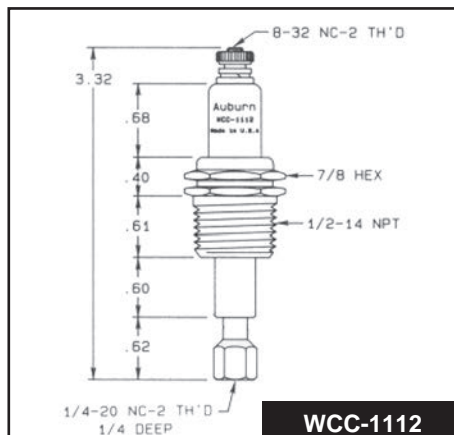

**WCC-1112**

No.	Ref. No.
E5-WCC-1112	WCC-1112

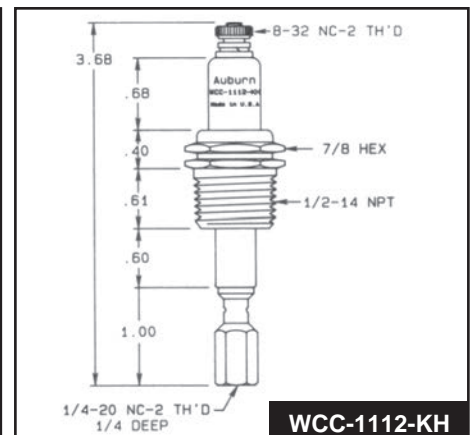

**WCC-1112-KH**

No.	Ref. No.
E5-WCC-1112-KH	WCC-1112-KH

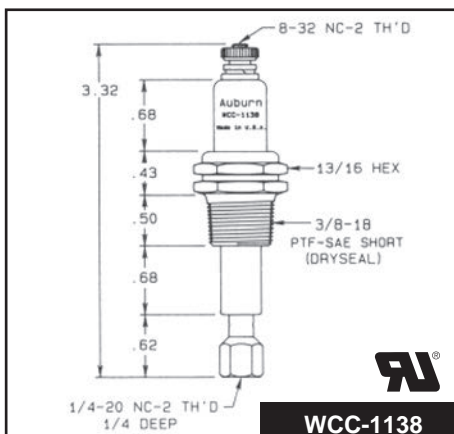

**WCC-1138**

No.	Ref. No.
E5-WCC-1138	WCC-1138

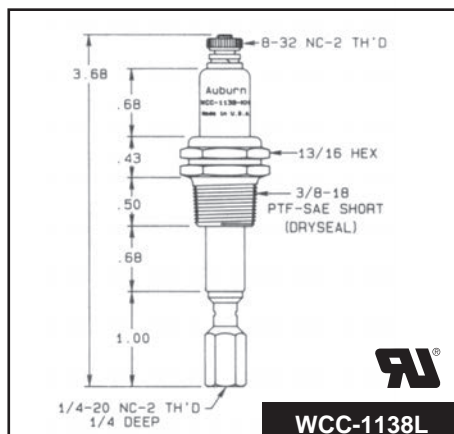

**WCC-1138L**

No.	Ref. No.
E5-WCC-1138L	WCC-1138L

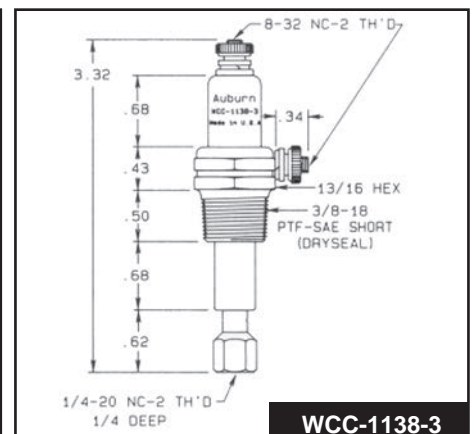

**WCC-1138-3**

No.	Ref. No.
E5-WCC-1138-3	WCC-1138-3

## AUBURN LIQUID LEVEL ELECTRODES

### WCT Series:

Metal parts are 303 or 304 non-magnetic stainless steel, center electrodes are one piece.

Non-steam applications up to 1,000 PSI at 120° F or 0 PSI at 400° F

Steam applications up to 100 PSI at 337° F

**WCT-90**

No.	Ref. No.
E5-WCT-90	WCT-90

**WCT-90-2**

No.	Ref. No.
E5-WCT-90-2	WCT-90-2

**WCT-912**

No.	Ref. No.
E5-WCT-912	WCT-912

**WCT-938**

No.	Ref. No.
E5-WCT-938	WCT-938

**WCTL-3814**

No.	Ref. No.
E5-WCTL-3814	WCTL-3814

As a major distributor of Auburn Liquid Level Electrodes, Westwood can special order any Auburn item not shown in this catalog and get it to you fast!

No.	Ref. No.	Thread	Length	Dia.
E5-1024-12	1024-12	10-24	12"	3/16"
E5-1024-18	1024-18	10-24	18"	3/16"
E5-1024-24	1024-24	10-24	24"	3/16"
E5-1420-6	1420-6	1/4-20	6"	1/4"
E5-1420-12	1420-12	1/4-20	12"	1/4"
E5-1420-18	1420-18	1/4-20	18"	1/4"
E5-1420-24	1420-24	1/4-20	24"	1/4"
E5-1420-36	1420-36	1/4-20	36"	1/4"
E5-3816-12	3816-12	3/8-16	12"	3/8"
E5-3816-18	3816-18	3/8-16	18"	3/8"
E5-3816-24	3816-24	3/8-16	24"	3/8"

### SOLID STAINLESS STEEL PROBES

#### FOR USE ON LIQUID LEVEL ELECTRODE ASSEMBLIES

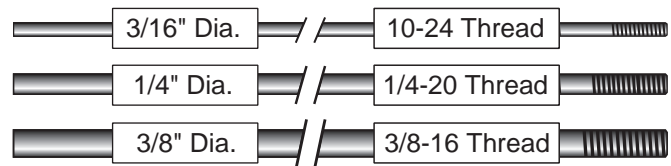

LIQUID LEVEL PROBES for FULTON BOILERS on page H9

### STANDARD SIZES\*

\*Made to order non-standard lengths available by special order.

Westwood

**CHAMPION**

**IGNITION ASSEMBLIES**



14 MM

**CJ-8**

 No.	Ref. No.
E5-CJ-8	CJ-8

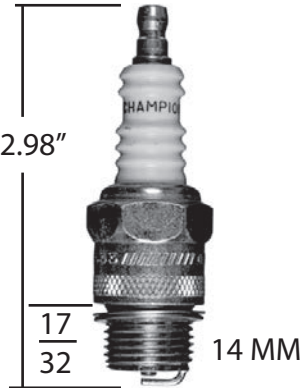



2.98"

$\frac{17}{32}$ "

14 MM

**D-9**

 No.	Ref. No.
E5-D-9	D-9



3.22"

1"

18 MM x 1.25MM

**D-89D**

 No.	Ref. No.
E5-D-89D	D-89D



14 MM x 1.25MM

**H14Y**

 No.	Ref. No.
E5-H14Y	H14Y

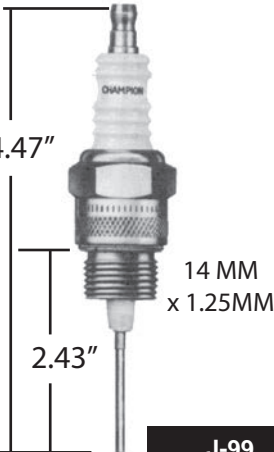

4.47"

2.43"

14 MM x 1.25MM

**J-99**

 No.	Ref. No.
E5-J-99	J-99



18 MM x 1.25MM

**K97F**

 No.	Ref. No.
E5-K97F	K97F

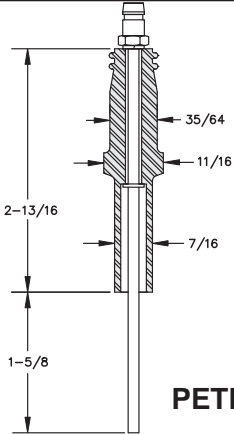

35/64

11/16

2-13/16

7/16

1-5/8

**PETRO**

**OA-9**

 No.	Ref. No.
E5-OA-9	OA-9

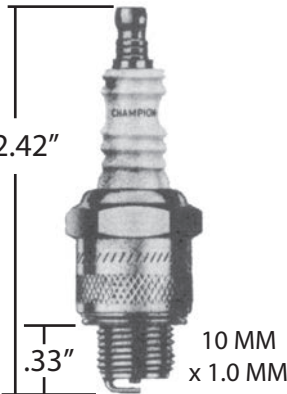

2.42"

.33"

10 MM x 1.0MM

**UY-6**

 No.	Ref. No.
E5-UY-6	UY-6



7/8-18 THD

**W18**

 No.	Ref. No.
E5-W18	W18

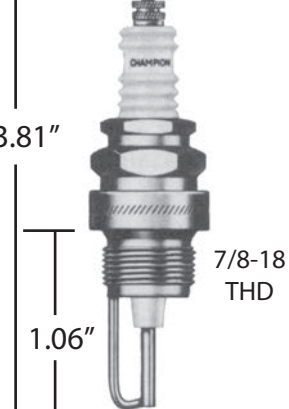

3.81"

1.06"

7/8-18 THD

**W-95D**

 No.	Ref. No.
E5-W-95D	W-95D

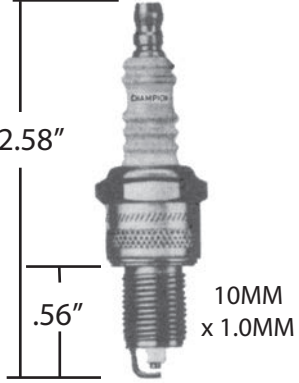

2.58"

.56"

10MM x 1.0MM

**Z-6**

 No.	Ref. No.
E5-Z-6	Z-6



# TERMINALS



## SPECIAL NOTE: NEW **Rajah™** TERMINAL PART NUMBERS

**Rajah™** terminals and related items part numbers are now "E9-" followed by the former part number.

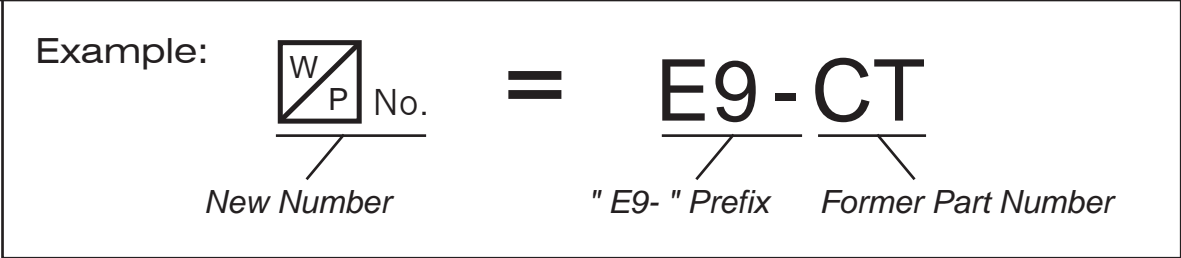

Note: Terminal part number endings of 6-32, 8-32, 10-24, and 10-32 refer to terminal thread size

 No. E9-CT	 No. E9-SS	 No. E9-R-2	 No. E9-SF	 No. E9-TT
 No. E9-CT-TS 8-32 E9-CT-TS 10-32	 No. E9-SS-TS 10-32	 No. E9-SR	 No. E9-HS 6-32 E9-HS 10-32	 No. E9-CT-BS 6-32 E9-CT-BS 8-32 E9-CT-BS 10-32
 No. E9-SS-BS 6-32 E9-SS-BS 8-32 E9-SS-BS 10-32	 No. E9-HT 6-32 E9-HT 8-32 E9-HT 10-32	 No. E9-SX-1 6-32 E9-SX-1 10-32	 No. E9-CT-SS	 No. E9-ACT
 No. E9-ASS	 No. E9-CHT	 No. E9-BS 6-32 E9-BS 8-32 E9-BS 10-24 E9-BS 10-32	 No. E9-458-9 10-32	 No. E9-RAC
 No. E9-RASS	 No. E9-EBS 6-32 E9-EBS 10-32	 No. E9-457-6 6-32	 No. E9-SS-SOS	 No. E9-R-SOS





# TERMINALS



Note: Terminal part number endings of 6-32, 8-32, 10-24, and 10-32 refer to terminal thread size

 WP No. E9-T-SOS	 WP No. E9-AS-SOS	 WP No. E9-BS-SOS	 WP No. E9-SSN	 WP No. E9-RSN
 WP No. E9-TSN	 WP No. E9-ASN	 WP No. E9-BSN	 WP No. E9-ACT-BS 6-32 E9-ACT-BS 10-32	 WP No. E9-DS-1
 WP No. E9-FF-1	 WP No. E9-CC-1	 WP No. E9-SS-LBS	 WP No. E9-SS-LTS	 WP No. E9-XC
 WP No. E9-SA-1 6-32	 WP No. E9-ITN 8-32 E9-ITN 10-32	 WP No. E9-ITN-S 6-32 E9-ITN-S 8-32	 WP No. E9-TC-10	 WP No. E9-TS-10
 WP No. E9-R-1	 WP No. E9-RS-3 10-32	 WP No. E9-RX-4 6-32 E9-RX-4 8-32 E9-RX-4 10-32	 WP No. E9-RX-5 10-32	 WP No. E9-RP-6
 WP No. E9-RC-5	 WP No. E9-RE-7	 WP No. E9-AEBF	 WP No. E9-EBF	 WP No. E9-B-10 10-32 5/16" Long
 WP No. E9-B-11 10-32 1 1/16" Long	 WP No. E9-BC-11	 WP No. E9-BS-12		

Please order by  No.





**TERMINALS**



Note: Terminal part number endings of 6-32, 8-32, 10-24, and 10-32 refer to terminal thread size

<p><i>Reckett</i> <b>DISCONTINUED</b> USE E9-Y5-10</p> <p>W/P No. E9-S-15 10-32</p>	<p>W/P No. E9-AL-10</p>	<p>W/P No. E9-AS-10</p>	<p>W/P No. E9-ASC</p>	<p>W/P No. E9-S-10</p>
<p>W/P No. E9-CS</p>	<p>W/P No. E9-YL-10</p>	<p>W/P No. E9-YS-10</p>	<p>W/P No. E9-YSC</p>	<p>1-1/8" Long</p> <p>W/P No. E9-SCS-2 6-32</p>
<p>1-1/4" Long</p> <p>W/P No. E9-SCS-1 10-32</p>	<p>W/P No. E9-KBN 6-32 E9-KBN 10-24</p>	<p>W/P No. E9-DT</p>	<p>W/P No. E9-CBS</p>	<p>Cleaver Brooks Spring Connects plate assembly to ignitors - 20" Long</p>

**SPECIALTY TERMINAL & ELECTRODE HARDWARE**

<p>1-1/2"</p> <p>Walter Kidde brass buss bar</p> <p>W/P No. E9-686 BAR</p>	<p>3/4" O.D. 9/16" I.D.</p> <p>7/16"</p> <p>Beveled and split brass bushing</p> <p>W/P No. E9-BB</p>	<p>1/2" O.D. 7/16" I.D.</p> <p>7/16"</p> <p>Zinc plated split steel bushing</p> <p>W/P No. E9-PB</p>	<p>9/16" O.D. 7/16" I.D.</p> <p>3/4"</p> <p>Zinc plated split steel bushing</p> <p>W/P No. E9-AB</p>	<p>5/8" O.D. 9/16" I.D.</p> <p>1"</p> <p>Zinc plated split steel bushing</p> <p>W/P No. E9-DB</p>
<p>3/4" O.D. - 9/16" I.D. 1/16" Thick</p> <p>Cleaver Brooks split ring zinc plated steel</p> <p>W/P No. E9-CBR</p>	<p>3/4" O.D. - 9/16" I.D. 1/16" Thick</p> <p>Copper gasket - dished</p> <p>W/P No. E9-467 GASKET</p>	<p>3/4" O.D. - 9/16" I.D. 1/32" Thick</p> <p>Copper gasket - flat</p> <p>W/P No. E9-I-18 GASKET</p>	<p>19/32" I.D. 3/4" O.D.</p> <p>1"</p> <p>Black bakelite shield for Ray</p> <p>W/P No. E9-500 SHIELD</p>	

**BUSS BARS**

W/P No.	Ref. No.	12" Length*
E9-TYPE ET	Type ET	Round brass with eyelet and 6-32 thread
E9-TYPE F	Type F	Flat brass with 1/8" hole
E9-TYPE ST	Type ST	Round brass with 6-32 thread

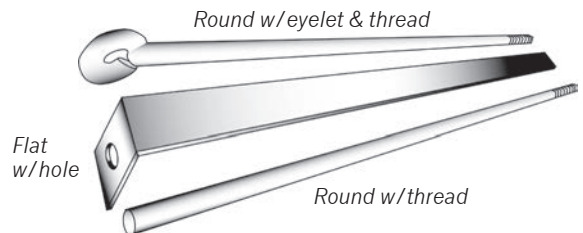



\* Other lengths available up to 24"

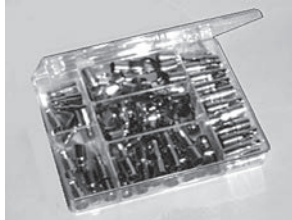

**IGNITION TERMINAL KITS**



 No.	Ref. No.	Description
E9-34	34	<b>Rajah™ "Mini" Ignition Terminal Kit:</b>
		20 - CT Cage Terminals 12 - SS Spring Snap Terminals 20 - R2 Ring Terminals 10 - RAC Right Angle Cage Terminals 12 - SF Stud Ferrule Terminals
E9-54	54	<b>Rajah™ Transformer Terminal Kit:</b>
		6 - AS-10 Short Adapter Spring 6 - AL-10 Long Adapter Spring 2 - TC-10 Thumb Nut on Cage 2 - 458-9 Spring Plunger (10-32) 4 - B-10 Button Contact (short) 2 - B-11 Button Contact (long) 6 - CC-1 Cage on Cage 6 - RC-5 Ram's Horn on Cage 4 - RX4 Ram's Horn on Hex 2 - R1 Ram's Horn Clip 6 - HS Hollow Stud (10-32) 6 - SX-1 Hex Stud (10-32)
E9-2097	2097	<b>Rajah™ "Pro" Ignition Terminal Kit:</b>
		24 - CT Cage Terminals 24 - SS Spring Snap Terminals 24 - R2 Ring Terminals 24 - SF Stud Ferrule Terminals 24 - RAC Right Angle Cage Terminals 100 - DT Distributor Terminals 24 - FF-1 Ferrule on Ferrule 1 - T200-10 (former #695) <b>Terminal Crimping Tool</b>
E9-3500	3500	<b>Rajah™ "Deluxe" Ignition Terminal Kit:</b>
		12 - CT Cage Terminals 12 - SS Spring Snap Terminals 12 - R2 Ring Terminals 12 - ACT Angle Cage Terminals 12 - SF Stud Ferrule Terminals 12 - BS Base Stud (6-32) 12 - BS Base Stud (10-32) 12 - HS Hollow Stud (6-32) 12 - HS Hollow Stud (10-32) 12 - CC-1 Cage on Cage 12 - CT-TS Cage on Stud (10-32) 12 - RC-5 Ram's Horn on Cage 12 - R-1 Ram's Horn Clip 12 - #299 Special GE Slotted Stud 12 - SX-1 Hex Stud (10-32) 1 - 1/4" Nut Driver 1 - 5/16" Nut Driver 1 - T200-10 (former #695) <b>Terminal Crimping Tool</b>
E9-CK-1	CK-1	<b>Rajah™ Carlin Transformer Contact Kit:</b>
		For in the field conversion on Carlin Burner models 98, 99, 100, 101, 102 Webster transformer model 313-28AB85 2 - Contact clips 2 - Flat washers (#10) 2 - Shakeproof washers (#10) 2 - 10-32 nuts

Please order by  No.

**ELECTRICAL CLIPS & RUBBER BOOTS**

 <p><input checked="" type="checkbox"/> No. E9-LV CLIP</p>	<p>Vinyl</p>  <p><input checked="" type="checkbox"/> No. E9-LV BOOT</p>	 <p><input checked="" type="checkbox"/> No. E9-20 AMP CLIP</p>	<p>Vinyl</p>  <p><input checked="" type="checkbox"/> No. E9-20 AMP BOOT</p>
<p>Distributor nipple</p>  <p><input checked="" type="checkbox"/> No. E9-DN</p>	<p>Silicone Rubber</p>  <p><input checked="" type="checkbox"/> No. E9-250 BOOT</p>	<p>Silicone Rubber</p>  <p><input checked="" type="checkbox"/> No. E9-251 BOOT</p>	





Take a look ...

JUMPERS & CORD CLIP SETS on page T13

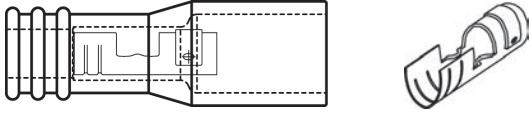
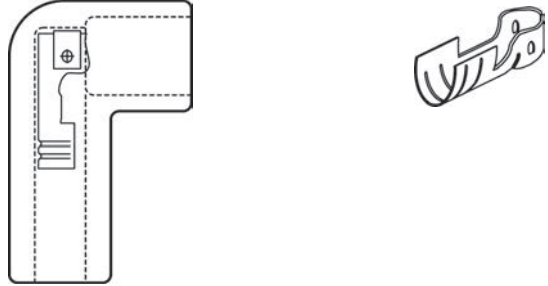
**HIGH TEMPERATURE CERAMIC SPARK PLUG BOOTS with Stainless Steel Terminals**

<input checked="" type="checkbox"/> No.	Ref. No.	Description
E9-ECF	ECF	EXTENDED CERAMIC BOOT - with stainless steel terminal for 7mm ignition wire 
E9-AECF	AECF	ANGLE EXTENDED CERAMIC BOOT - with stainless steel terminal for 7mm ignition wire 

**Westwood IGNITION CABLE**

Cable Type	 <b>UL</b> Recognized Component	 No.		
		25' Roll	100' Roll	1,000' Roll
GTO-15	Yes	E60-25	E60-100	E60-1000
White Silicone	-	E62-25	E62-100	-
Red Silicone	Yes	E63-25	E63-100	E63-1000

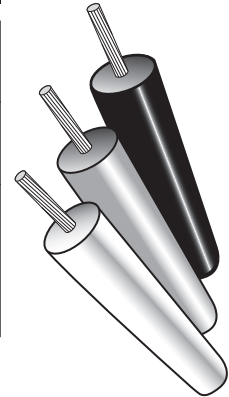

<b>GTO-15</b> (black)	Large .275" outside diameter fits Rajah terminals perfectly. Withstands more than <b>15,000 VAC</b> with low current leakage. Resists arc-over, tracking, and burning. Tested to withstand conditions of heat, oil, and moisture. No. 14 gauge, 19 x 26 stranded tinned copper wire. All vinyl insulation affords low temperature flexibility. Flame retardant, will not support combustion. Tough and abrasion resistant, yet easy stripping. Temperature range: <b>UL Recognized</b> to 105° C (221° F)
<b>White Silicone</b>	Large .275" outside diameter fits Rajah terminals perfectly. Withstands more than <b>10,000 VAC</b> and <b>25,000 VDC</b> with low current leakage. No. 16 gauge, 19 x 26 stranded tinned copper wire. Natural Silicone insulation, high dielectric strength. Temperature range: -65° F to 400° F (-54° C to 204° C)
<b>Red Silicone</b>	Large .275" outside diameter fits Rajah terminals perfectly. Withstands more than <b>10,000 VAC</b> and <b>25,000 VDC</b> with low current leakage. No. 16 gauge, 19 x 26 stranded nickel plated copper wire. Natural Silicone insulation, high dielectric strength. Temperature range: -65° F to 482° F (-54° C to 250° C) <b>UL Recognized</b>

**CABLE ASSEMBLIES and FIBERGLAS BRAID**

 No.	Ref. No.	Description
E64	#3250	Red Silicone wire <b>high temperature</b> cable assembly with protective <b>metal braid</b> . Temperature range -65° F to 450° F. Overall length is 32-1/2".
E64-5	#RS-3350	Red Silicone wire <b>high temperature</b> cable assembly with red Silicone <b>boots</b> . Temperature range -65° F to 450° F. Withstands <b>10,000 VAC / 25,000 VDC</b> . Overall length is 33-1/2".
E64-20	#3253	Fiberglass braided sleeving. Fits over ignition cable for high temperature protection. Sold by the foot. (Ordering example: For 5' of sleeving order 5 of E64-20. Shipped as one piece)

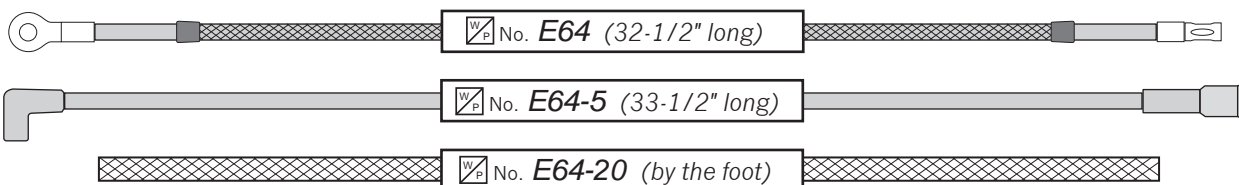

Please order by  No.

rev. 12-14-15

**E30**

**ELECTRICAL ACCESSORIES**



**SOLDERLESS TERMINAL KIT**

No. **E70**

Contains 175 of the most popular terminals and connectors

**KIT REFILL TERMINALS - Part numbers are for a package of the quantity indicated**

 AWG: 22-16 Female .250 Tab No. E70-10	 AWG: 22-16 Ring #6 Stud No. E70-20	 AWG: 16-14 Ring #8 Stud No. E70-21	 AWG: 16-14 Spade #8 Stud No. E70-34	 AWG: 16-14 Spade #10 Stud No. E70-36	 AWG: 22-16 Butt Connector No. E70-40
<b>BACK ROW - All Packages of 100</b>					
 AWG: 16-14 Female .250 Tab No. E70-12	 AWG: 22-16 Ring #10 Stud No. E70-22	 AWG: 16-14 Ring #10 Stud No. E70-23	 AWG: 16-14 Spade #6 Stud No. E70-30	 AWG: 22-16 Spade #6 Stud No. E70-32	 AWG: 16-14 Butt Connector No. E70-42
<b>MIDDLE ROW - Packages of 100</b>					<b>Pkg. of 50</b>
 AWG: 12-10 Female .250 Tab No. E70-14	 AWG: 12-10 Ring #10 Stud No. E70-24	 AWG: 12-10 Ring 1/4" Stud No. E70-25	 AWG: 12-10 Ring 5/16" Stud No. E70-26	 AWG: 12-10 Spade #10 Stud No. E70-38	 AWG: 12-10 Butt Connector No. E70-44
<b>FRONT ROW - All Packages of 50</b>					

**WIRE CONNECTORS - Part numbers are for a package of 100**

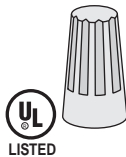

	GREY	BLUE	ORANGE	YELLOW	RED
No.	E70-50	E70-52	E70-54	E70-56	E70-58

**CABLE TIES - Part numbers are for a package of 100**

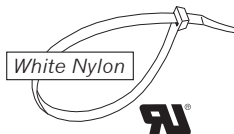

	4"	5-1/2"	7-1/2"	11"	14"
No.	E70-60	E70-62	E70-64	E70-66	E70-68

**ROUGH SERVICE BULBS**

Part numbers are for a box of 2 bulbs

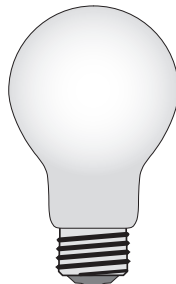

	75 Watt	100 Watt
No.	E70-75	E70-100



**Westwood**  
**CAD CELL FLAME DETECTORS**

UNIVERSAL REPLACEMENT FOR HONEYWELL AND WHITE-RODGERS

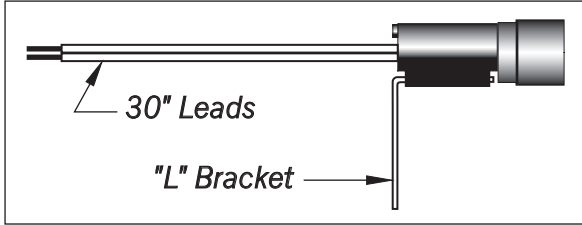
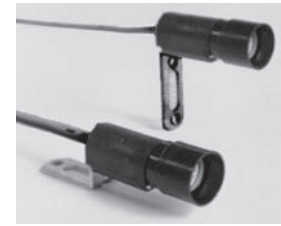

No. **E80**

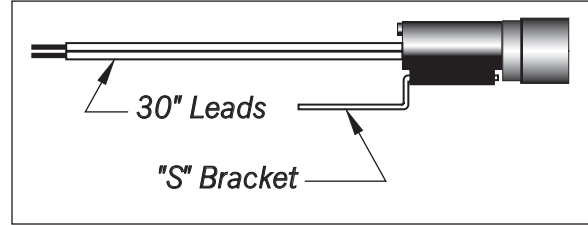

No. **E80-1**

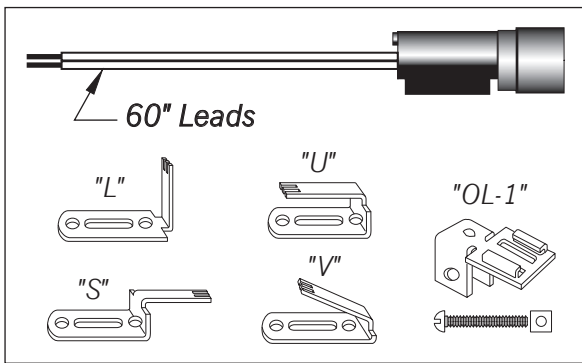

No. **E80-2**

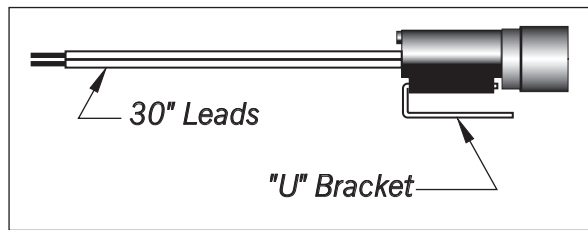

No. **E80-3**

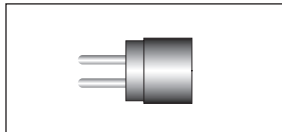

No. **E81**



No. **E81-10**

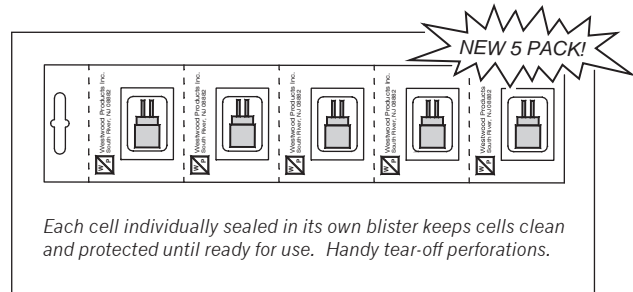

No. **E81-5**

No.	Ref. No.	Description
E80	TM-30L	Complete flame detector with cad cell eye*, 30" leads, "L" bracket, poly bag package
E80-1	TM-30S	Complete flame detector with cad cell eye*, 30" leads, "S" bracket, poly bag package
E80-2	TMK-60	Complete flame detector kit with cad cell eye*, 60" leads, "L" bracket, "S" bracket, "U" bracket, "V" bracket, "OL-1" special oil line bracket with mounting screw and nut, packaged in a box
E80-3	-	Complete flame detector with cad cell eye*, 30" leads, "U" bracket, poly bag package
E81	Type M	Cad cell eye* packaged in a box
E81-5	-	Cad cell eye* <b>5 pack</b> (blister card with 5 E81-5 eyes per card), tear-off perforations
E81-10	Type W	<del>Cad cell eye, bayonet mount for White-Rodgers cad cell flame detector</del> <b>DISCONTINUED</b>

\* Cad cell eye replaces Honeywell 130367 and fits C554A flame detector



T70 Cad cell relay and eye tester on page T11

Please order by No.



# THERMOSTAT GUARDS

METAL AND PLASTIC TAMPER PROOF DESIGNS IN PLEASING COLORS

*Designed for use in schools, industrial plants and military installations where **rugged, maximum protection** is the first consideration. The louvered covers cannot be twisted or jammed open. Bobby pins, pencils, letter openers and other such objects cannot be inserted through the cover to adjust the thermostat.*

- ▶ Metal guards are constructed of 18-22 gauge steel with a baked enamel finish
- ▶ Plastic guards are molded from hi-impact plastic and can be used with both horizontally or vertically mounted thermostats
- ▶ All guards come with eight tumbler lock, one key, and mounting hardware
- ▶ Guards with ring bases can be installed without removing the thermostat



No. **E140**



No. **E140-1**

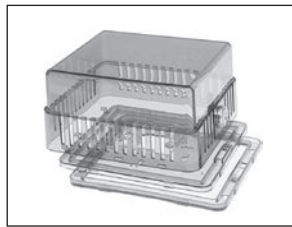

No. **E141**

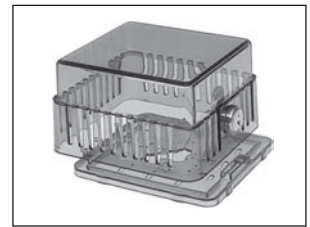

No. **E142**



No. **E142-1**



No. **E142-2**



No. **E142-3**

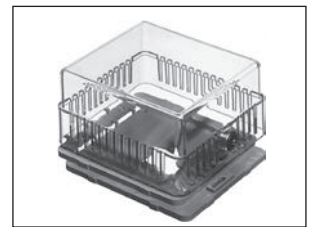

No. **E143**

No.	Ref. No.	Inside Dimensions H" x W" x D"	Mat'l	Color	Base	Comments
<b>E140</b>	WTG-54VL	6-1/4 x 4-3/4 x 3	M	BE	SH	T80, T90, T91, T199, T330, T340, T42, T26, T87, T92, T651, T921, T872, T882
<b>E140-1</b>	WTG-54VLW	6 x 3-13/16 x 3-1/8	M	BE	RH	
<b>E141</b>	WTG-B	5-1/4 x 4-5/8 x 3-1/4	P	BR	SR	T199, TP970, TP971, TP972, TP973, T26, T87, TS86, T832, T853, TP910
<b>E142</b>	WTG-EB	3-7/8 x 3-1/2 x 2-1/2	P	BR	S	
<b>E142-1</b>	WTG-EK	3-7/8 x 3-1/2 x 2-1/2	P	CL	S	
<b>E142-2</b>	WTG-EM	3-7/8 x 3-1/2 x 2-1/2	M	BE	S	
<b>E142-3</b>	WTG-EO	3-7/8 x 3-1/2 x 2-1/2	P	OP	S	
<b>E143</b>	WTG-K	5-1/4 x 4-5/8 x 3-1/4	P	CL	SR	

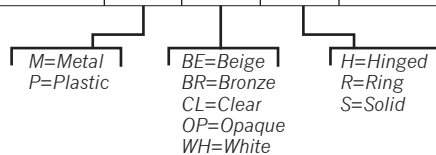

# THERMOSTAT GUARDS (CONTINUED)

METAL AND PLASTIC TAMPER PROOF DESIGNS IN PLEASING COLORS

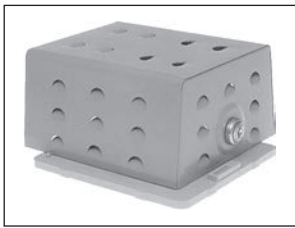

No. **E143-1**

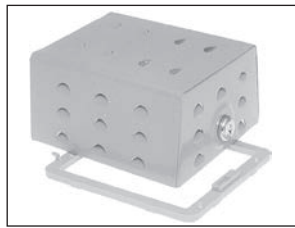

No. **E143-2**

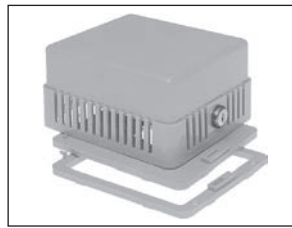

No. **E143-3**

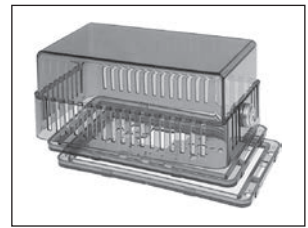

No. **E144**

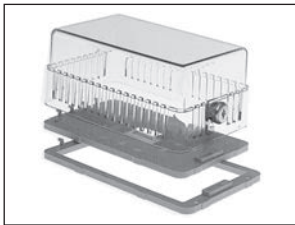

No. **E144-1**

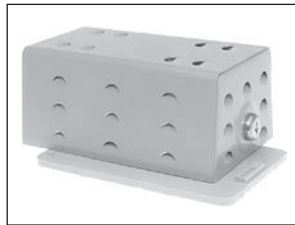

No. **E144-2**

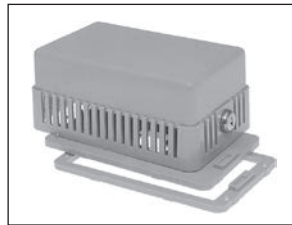

No. **E144-3**

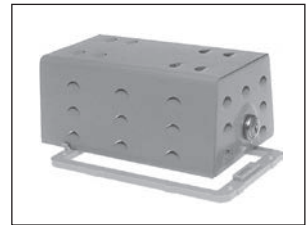

No. **E144-4**

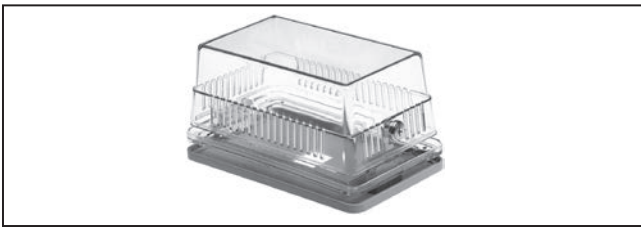

No. **E145 Series**

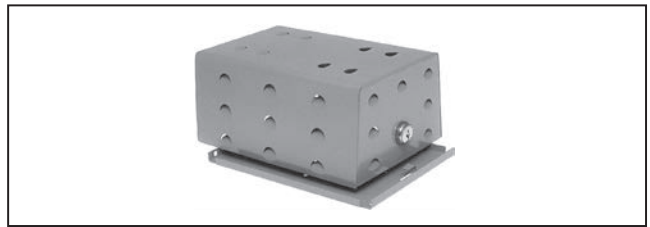

No. **E146**

No.	Ref. No.	Inside Dimensions H" x W" x D"	Mat'l	Color	Base	Comments
<b>E143-1</b>	WTG-KM	5-1/4 x 4-5/8 x 3	M	BE	S	
<b>E143-2</b>	WTG-KWM	5-1/4 x 4-5/8 x 3-1/4	M	BE	R	
<b>E143-3</b>	WTG-O	5-1/4 x 4-5/8 x 3-1/4	P	OP	SR	
<b>E144</b>	WTG-RB	6-3/8 x 3-1/2 x 3-1/4	P	BR	SR	
<b>E144-1</b>	WTG-RK	6-3/8 x 3-1/2 x 3-1/4	P	CL	SR	T80, T90, T91, T99, T199, T330, T340, T42, TA42, T26, TS86, T87, T92, T498, T651, T834, T921, T872, T882
<b>E144-2</b>	WTG-RM	6-3/8 x 3-1/2 x 3	M	BE	S	
<b>E144-3</b>	WTG-RO	6-3/8 x 3-1/2 x 3-1/4	P	OP	SR	
<b>E144-4</b>	WTG-RWM	6-3/8 x 3-1/2 x 3-1/4	M	BE	R	
<b>E145</b>	WTG-UB2	8-1/8 x 4-5/8 x 3-5/8	P	BR	SR	General, White-Rodgers, Barber Colman, Honeywell, Robertshaw, Camstat, Penn
<b>E145-1</b>	WTG-UK2	8-1/8 x 4-5/8 x 3-5/8	P	CL	SR	
<b>E146</b>	WTG-UM	7-1/4 x 5-3/8 x 3-1/2	M	BE	S	

M=Metal  
 P=Plastic  
 BE=Beige  
 BR=Bronze  
 CL=Clear  
 OP=Opaque  
 WH=White  
 H=Hinged  
 R=Ring  
 S=Solid

Please order by No.

# THERMOSTAT GUARDS (CONTINUED)

METAL AND PLASTIC TAMPER PROOF DESIGNS IN PLEASING COLORS

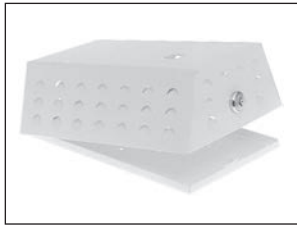

No. **E147 Series**

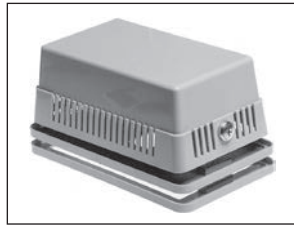

No. **E148**

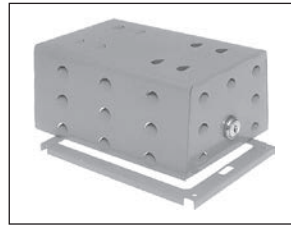

No. **E149**

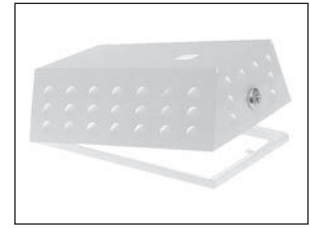

No. **E150 Series**

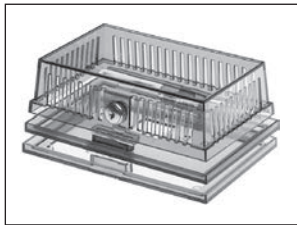

No. **E151**

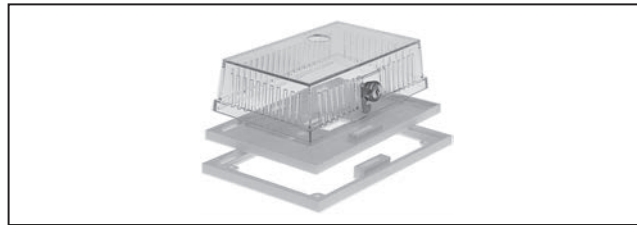

No. **E151-1, -2**



No. **E151-3**

No.	Ref. No.	Inside Dimensions H" x W" x D"	Mat'l	Color	Base	Comments
<b>E147</b>	WTG-UM1	9-3/8 x 6-3/4 x 3	M	WH	SH	Honeywell T7300 series
<b>E147-1</b>	WTG-UM1DH	9-3/8 x 6-3/4 x 3	M	WH	SH	Honeywell T7300 series w/display opening
<b>E147-2</b>	WTG-UM1DOH	9-3/8 x 6-3/4 x 3	M	WH	SH	Honeywell T7300 series w/override/display opening
<b>E147-3</b>	WTG-UM1DOWR	9-3/8 x 6-3/4 x 3	M	WH	SH	White-Rodgers IF90 series w/override/display opening
<b>E147-4</b>	WTG-UM1OH	9-3/8 x 6-3/4 x 3	M	WH	SH	Honeywell T7300 series w/override opening
<b>E147-5</b>	WTG-UM1SDH	9-3/8 x 6-3/4 x 3	M	WH	SH	Honeywell T7400 series w/display opening
<b>E148</b>	WTG-UO2	8-1/8 x 4-5/8 x 3-5/8	P	OP	SR	
<b>E149</b>	WTG-UWM	6-3/4 x 4-1/4 x 3-9/16	M	BE	R	
<b>E150-1</b>	WTG-UWM1DH	9-3/8 x 6-3/4 x 3	M	WH	RH	Honeywell T7300 series w/display opening
<b>E150-2</b>	WTG-UWM1DOH	9-3/8 x 6-3/4 x 3	M	WH	RH	Honeywell T7300 series w/override/display opening
<b>E150-3</b>	WTG-UWM1DOWR	9-3/8 x 6-3/4 x 3	M	WH	RH	White-Rodgers IF90 series w/override/display opening
<b>E150-4</b>	WTG-UWM1OH	9-3/8 x 6-3/4 x 3	M	WH	RH	Honeywell T7300 series w/override opening
<b>E150-5</b>	WTG-UWM1SDH	9-3/8 x 6-3/4 x 3	M	WH	RH	Honeywell T7400 series w/display opening
<b>E151</b>	WTG-DB	4-1/8 x 7-1/16 x 2-1/4	P	BR	SR	
<b>E151-1</b>	WTG-DK	4-1/8 x 7-1/16 x 2-1/4	P	CL	SR	
<b>E151-2</b>	WTG-DK1	4-1/8 x 7-1/16 x 2-1/4	P	CL	SR	w/override opening
<b>E151-3</b>	WTG-DO	4-1/8 x 7-1/16 x 2-1/4	P	OP	SR	

M=Metal  
 P=Plastic  
 BE=Beige  
 BR=Bronze  
 CL=Clear  
 OP=Opaque  
 WH=White  
 H=Hinged  
 R=Ring  
 S=Solid

## ULTRAGLO™ Thermostat Light

Mounts anywhere!



*This easy to mount battery powered light has an ultra bright bulb that draws little current. It can be mounted in any convenient location with the two mounting screws provided. Easily slips out of its mounting bracket for use as a hand light. Use in cars, boats, RVs and campers too!*

 No. **E140-40**

## REPLACEMENT ZONE VALVE MOTOR

For motor driven OPEN, spring return CLOSE valves  
(ie. Erie, Flare, Honeywell, Superior)

**INSTALLS WITHOUT REMOVING VALVE FROM PIPING  
USING EASY TO INSTALL EXTENDED BRASS SCREWS**

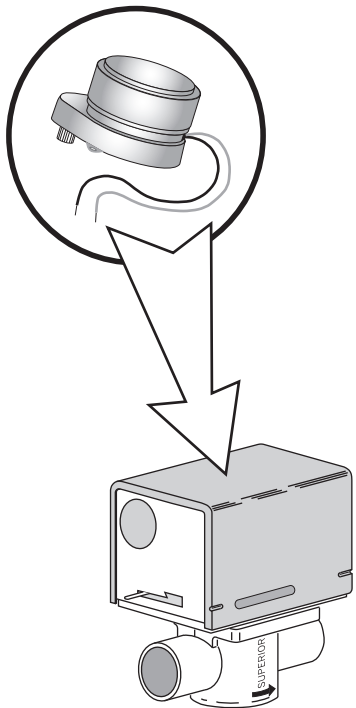

**New easy to install screws!**

 No.	Description
<b>E180</b>	Individually packaged with installation instructions, wire nuts, and easy to install extended brass mounting screws 24 VAC, 50/60 Hz, .32 A