



FlameWorx II

Flame Switch Modules for DIN
Rail or Panel Mounting



DESCRIPTION

The FlameWorx II modules provide visual indication and electrical output that signal the user regarding flame presence or absence in a combustion chamber. The modules use Fireeye optical ultra-violet scanners to sense flame presence and act as components in a burner management system. Six different models of the control provide many operational characteristics including:

- Dual channel capability that separately monitors two flames with independent outputs and LED status
- Compatible with 8 different UV and UV Self Checking scanners
- LED Visual indication of:
 - Power
 - Flame presence
 - System diagnostics that provide informational codes
- Single Pole/Double Throw (SPDT) Flame relay output for each channel
- Opto-isolated DC outputs (open collector transistor) for each channel
- 4-20 ma analog flame signal for each channel, available either from the wiring base or from front panel test jacks on some models
- Selectable Flame Failure Response Time (FFRT) of 1, 2, 3 or 4 seconds
- Panel Surface or DIN Rail Mounting

Check with Fireeye for more details by contacting your local distributor or by checking the Fireeye home page at www.fireeye.com

Note: When the FlameWorx II modules are used, some additional means must be furnished to provide those functions required in flame safeguard control systems regulations for your locale.



IMPORTANT: FlameWorx II modules are shipped from the factory with a 1 second FFRT. Refer to the "FFRT Settings" section of this bulletin for instructions on how to modify this setting.

Note: See Fireeye bulletins SC-101 and SC-102 for more details on other accessories used with the FlameWorx II products including flame scanners.



NOTICE: When Fireeye products are combined with equipment manufactured by others and/or integrated into systems designed or manufactured by others, the Fireeye warranty, as stated in its General Terms and Conditions of Sale, pertains only to the Fireeye products and not to any other equipment or to the combined system or its overall performance.



ORDERING INFORMATION

FlameWorx II Model Numbers

Part Number	Description
MBUV-300D	2-Channel module with test jacks, use with UV1A, UV2, UV8, UV90, 45UV3 scanners
MBUV-310D	2-Channel module without test jacks, use with UV1A, UV2, UV8, UV90, 45UV3 scanners
MBUVS-301D	2-Channel module with test jacks, use with 45UV5-1007,-1008,-1009, 55UV5-1007,-1009 scanners
MBUVS-311D	2-Channel module without test jacks, use with 45UV5-1007,-1008,-1009 55UV5-1007,-1009 scanners

Wiring Base

Part Number	Description
MBB-300D	Wiring base for all UV modules, DIN clip included

Power Supplies

Part Number	Description
* MBLPS-100D	Power Supply 120 VAC to 24VDC for up to 10 Modules, DIN Mounting
* MBHPS-100D	Power Supply 120 VAC to 600 V. for UV Scanners, DIN Mounting (Will power up to 20 scanners)
* MBLPS-200D	Power Supply 230 VAC to 24VDC for up to 10 Modules, DIN Mounting
* MBHPS-200D	Power Supply 230 VAC to 600 V. for UV Scanners, DIN Mounting (Will power up to 20 scanners)

* The MBLPS and MBHPS power supplies *may not* be used when CE certification is required. When CE certification is required, the power supplies must meet SELV standards according to EN60742

Mounting Rails

Part Number	Description
60-2539-12	DIN style mounting rail, 12 inches, mounts up to 4 modules
60-2539-24	DIN style mounting rail, 24 inches, mounts up to 8 modules
60-2539-36	DIN style mounting rail, 36 inches, mounts up to 12 modules

Flame Scanners

Part Number	Description
UV1A3	Ultra-violet scanner, non-self checking applications, 1/2" NPT mount, 3' lead
UV1A6	Ultra-violet scanner, non-self checking applications, 1/2" NPT mount, 6' lead
UV2	Ultra-violet scanner, non-self checking applications, 3/8" NPT mount, 3' lead
UV8A	Ultra-violet scanner, non-self checking applications, 1/2" NPT 90 deg., 6' lead
45UV3-1050	Ultra-violet scanner, non-self checking applications, 3/4" NPT mount
45UV5-1007	Ultra-violet self checking scanner, 1" BSP mount, 230 VAC
45UV5-1008	Ultra-violet self checking scanner, 1" BSP mount, 120 VAC
45UV5-1009	Ultra-violet self checking scanner, 1" NPT mount, 120 VAC
UV90-3	UV 90° lateral view with 36" (915mm) flex conduit
UV90-6	UV 90° lateral view with 72" (1830mm) flex conduit
UV90-9	UV 90° lateral view with 108" (2745mm) flex conduit



PRODUCT SPECIFICATIONS

FlameWorx II Modules

Supply Voltage:	24VAC +10%, -15%, 50/60 HZ 24VDC +10%, -15%
Power Consumption:	With two UV scanners of any type 2.5 W (110ma @ 24VDC)
Flame Relay Output: (One per channel)	SPDT 5 Amp Resistive @240VAC, 3 A @24VDC (Due to safety standards spacing requirements, the relay outputs must use the same voltage on both channels)
Flame Signal Output: (Wiring base terminals or test jacks)	4-20 ma (current source) analog output (1 per channel) Meter requires less than 750 ohms impedance (one per channel). 300D & 301D models have front face test jack access to analog output.
Opto-Isolated Transistor Output: (One per channel)	DC Voltage Only, Polarity Sensitive, 32 VDC Maximum, 10ma maximum per output Non Safety Use-Indication Only

Power Supplies

<u>Model</u>	<u>Input</u>	<u>Output</u>	<u>Max # of Modules/Scanners</u>
MBLPS-100D	120VAC	1.4 A @ 24VDC	10 Modules/ 20 Scanners
MBLPS-200D	230VAC	1.4 A @ 24VDC	10 Modules/ 20 Scanners
MBHPS-100D	120VAC	25mA @ 600 V	20 Flame Scanners
MBHPS-200D	230VAC	25mA @ 600 V	20 Flame Scanners

Operating Temperature:	-40° F to 140° F (-40° C to 60° C)
Storage Temperature:	-40° F to 176° F (-40° C to 80° C)
Humidity:	85% RH max. non-condensing
Shipping Weights:	MBB-300D 1.12 lb. (.5Kg) MB Modules 2.34 lb. (1.06Kg)
Housing:	IP40, NEMA 1

AGENCY CERTIFICATIONS

CE:	MBUV-300D and MBUV-310 are approved with non self-checking UV sensors for non permanent operation. MBUV-301D and MBUVS-311D in combination with approved self-checking scanners are intended for permanent operation.
Gas Appliance Directive:	90/396/EEC
Low Voltage Directive:	73/23/EEC
EMC Directive:	89/336/EEC
GASTEC:	0063BM18844 (EN298, October 1993; EN230, November 1990)
Apave:	D15/059
Underwriters Laboratory:	MCCZ2, File MP1537 Controls, Primary Safety - Component MCCZ8, File MP1537 Controls, Primary Safety Certified for Canada
Factory Mutual:	Approved

FUNCTIONAL OPERATION and FEATURES

Analog Flame Signal

An analog flame signal is available to the user on terminals 4, 7 and 8 on the wiring base. These will give you a 4-20 ma analog signal for both channels. Channel #1 is found between terminals 4 and 8. Channel #2 is found between terminals 4 and 7. If you have purchased the MBUV-300D or the MBUVS-301D, you will have access to this analog signal from the face of the control as well as from the wiring base terminals. This will allow you to use a portable voltmeter or permanently wire these to a remote meter if you do not want to use the terminals in the wiring base. Meters must have less than 750 ohms impedance.

Simultaneous operation of both the test jacks and the analog signal from the wiring base is **NOT** allowed. You must use one or the other, but not both. Simultaneous operation will not harm the control, but it will give an incorrect signal at both locations.

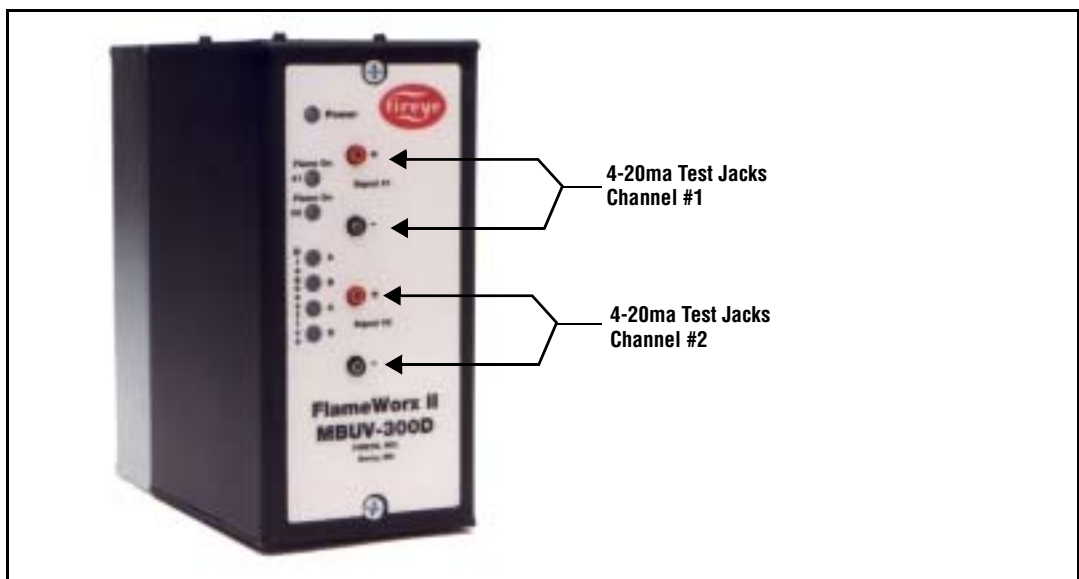

CAUTION: The analog signals must not be used for safety purposes. They are used for indication only.

LED INDICATORS

Power

The green Power LED on the face of the control indicates that there is power to the control through the wiring base. If this LED is not lit, check for proper power wiring or other power supply problems.

Flame On

There are two yellow "Flame On" indication LED's, one for each channel. When the LED is lit, the relay is energized and it is a visual indication that there is flame present at the flame scanner corresponding to the channel that is lit.

Diagnostics

The four red diagnostic LED's on the face of the control are designed to give the user information about the control and system failures. There are 4 conditions that can be indicated by various sequences of the LED's. You may activate and de-activate the diagnostic LED's by selecting this function on the underside of the control. When not selected, the LED's will not function under any circumstances.

The LED lights labeled "A" and "B" designate information about Channel 1. The LED lights labeled "C" and "D" designate information about Channel 2.

Note: The diagnostic LED function can be de-activated by removing the jumper found on the third pin set on the underside of the module.

Summary of Codes:

LED	SIGNAL	PROBLEM - SOLUTION
A	STEADY	Channel # 1 Failure - Replace Module
B	STEADY	Channel #1 Shutter Failure - Check Scanner Wiring - Replace Scanner
C	STEADY	Channel # 2 Failure - Replace Module
D	STEADY	Channel #2 Shutter Failure - Check Scanner Wiring - Replace Scanner

Note: Shutter failures will automatically clear if the fault is corrected on the next good shutter cycles.

Note: Some failure modes may be cleared by recycling power.

FLAME FAILURE RESPONSE TIME (FFRT)

FFRT stands for flame failure response time. This is the maximum elapsed time from the loss of flame to the de-energizing of the flame relay and the opto-isolated transistor (open collector) output. The actual time is slightly less than the setting number. For instance, if you chose 4 seconds, the actual timing of FFRT is slightly less than four seconds.

The selection of FFRT is made using jumper plugs found on the underside of the FlameWorx II module. You must first remove the insulation paper to expose the FFRT window. Note the following series of pictures.



IMPORTANT: Before changing the FFRT setting, check to see what the local requirements are regarding this function. All modules are pre-set at the factory for the lowest FFRT (1 sec.). Therefore, do not power the module without making the proper selection first.



The underside of the module has a protective nomex insulator that must be removed to expose the FFRT jumpers. The paper will peel away from the side.

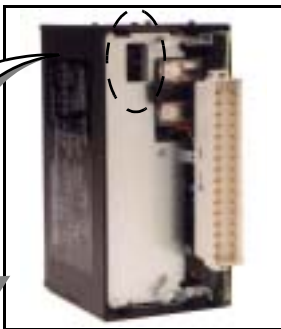

When the nomex insulator is removed, the module will look like this.



A close-up view of the jumper window shows the jumper pins and plugs used to select the FFRT. The following chart allows you to position the jumper plugs to select the FFRT desired. Extra jumper plugs are shown inserted into only one post. Only the upper two pin sets are used for FFRT selection. In the picture, the upper two pin sets shown not jumpered, selecting 1second FFRT.

The jumpers shown are resting on only one post. The third pin set is shown jumpered. This jumper activates the diagnostic LED's.

The fourth and fifth pin sets are unused

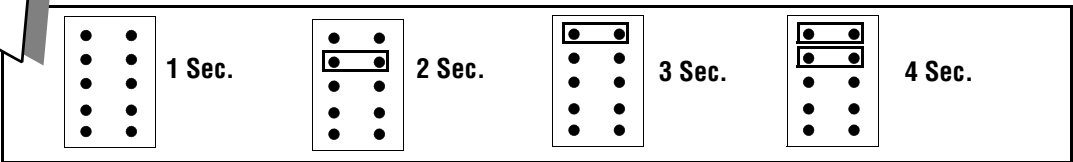



The possible settings are 1, 2, 3 and 4 seconds. In all cases, the actual flame failure response time is slightly less than the chosen value. **Note:** A 4 sec. FFRT is not allowed when CE certification is required.

Flame Relay Outputs

Two independent relays are available as outputs on the control. There is a Single Pole Double Throw relay for each of the two channels. Channel #1 relay output is found on terminals 28 (C), 29 (NO) and 30 (NC) of the wiring base. Channel #2 relay output is found on terminals 27 (C), 26 (NO) and 25 (NC). Use the same voltage on both channels.

Each relay will energize independently when flame is sensed at its designated flame scanner. The relay will de-energize when flame is not seen by the flame scanner after the selected FFRT timing.

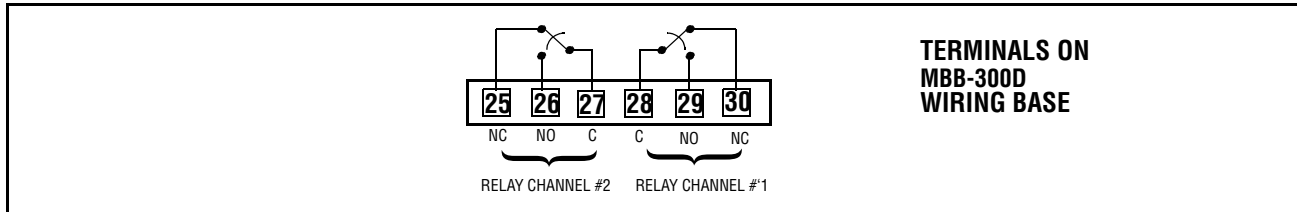

NOTE: It is advisable to test the load circuit before mounting the FLAMEWORX II on the wiring base, to make certain that the current is within the relay ratings.

Opto-Isolated Outputs

Two opto-isolated transistor (open collector) outputs are available on each module, one for each channel. The outputs act as a DC voltage switch. **They should not be used as a safety input.** Their use is specifically designed as a DC voltage input to low current devices such as Programmable Logic Controllers (PLC's). You must be cautious to maintain proper polarity when using these outputs and the DC voltage should be less than 32 volts. They will not function on AC voltage circuits.

Channel #2 output can be found on terminals 15 (-) and 16 (+). Channel #1 output can be found on terminals 17 (-) and 18 (+).

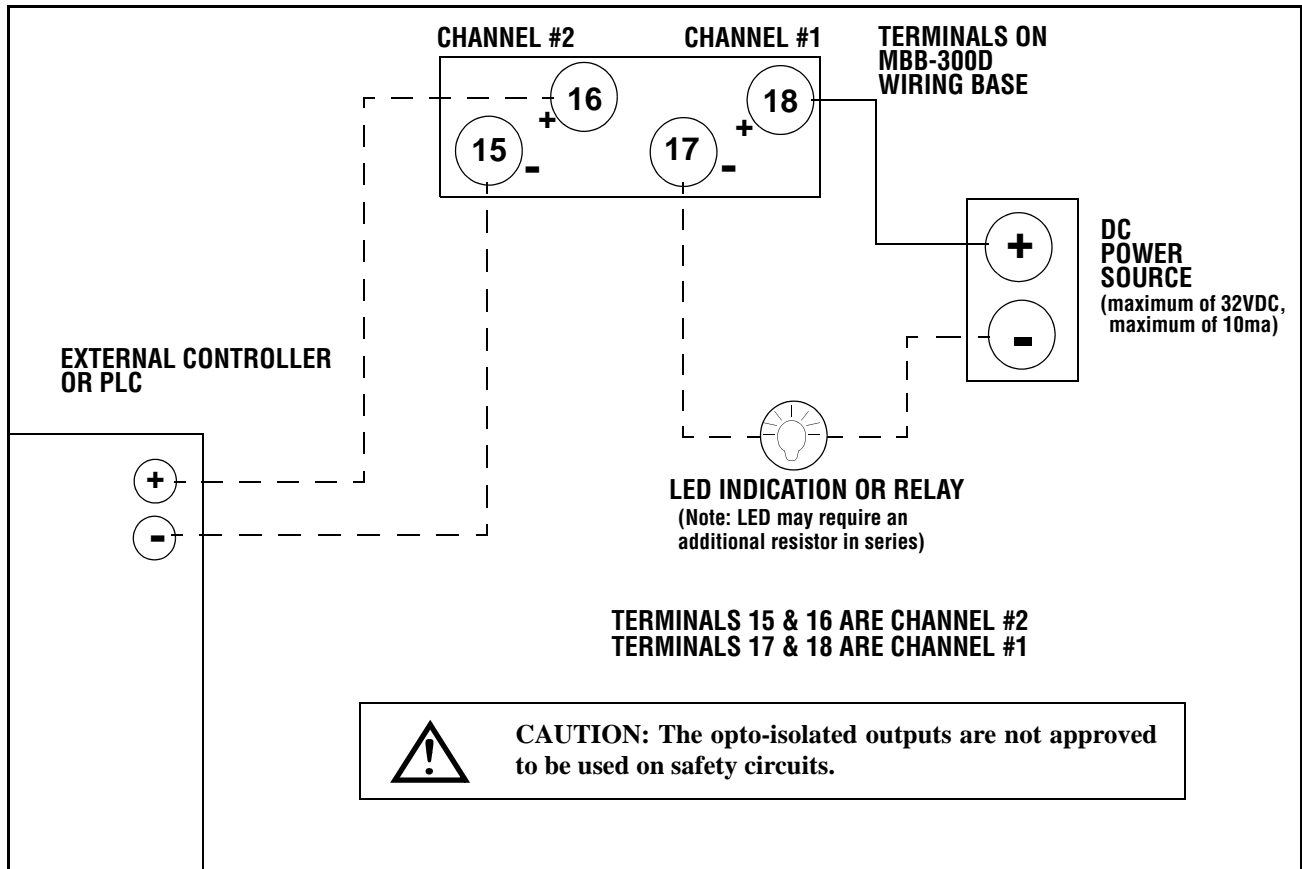

INSTALLATION GUIDE AND INSTRUCTIONS

MBB-300D WIRING BASE

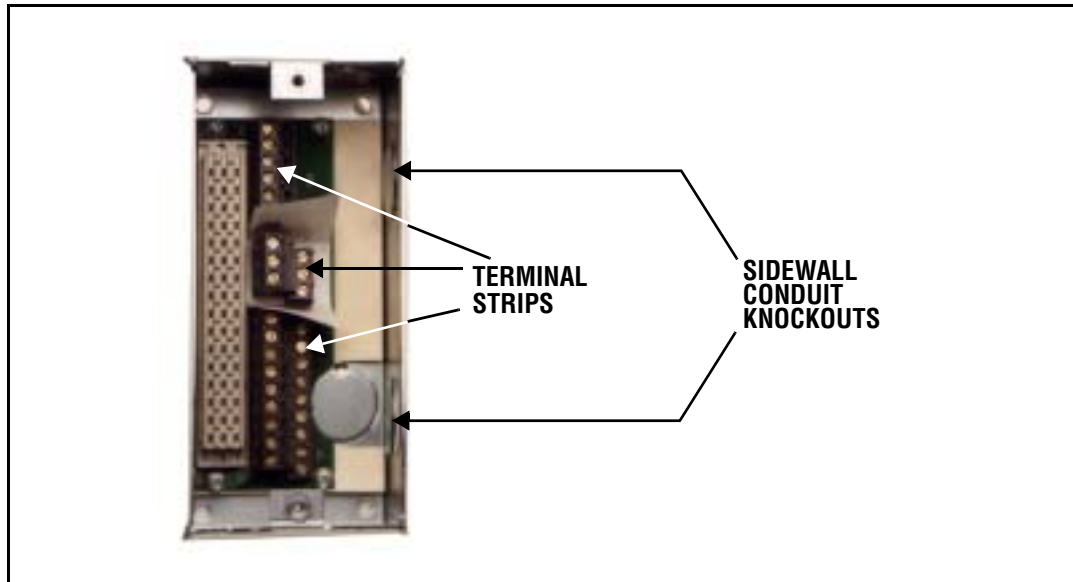

DIN MOUNTING CLIPS

One set of DIN mounting clips are shipped in every MBB-300D wiring base. The clips can be installed by removing the four screws that hold the wiring base terminal in place. The clips can be installed for either horizontal or vertical mounting on a DIN rail.

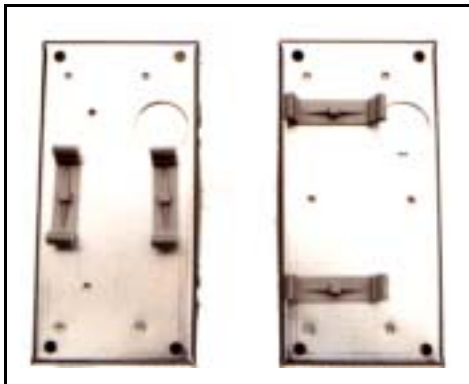

Two MBB-300D wiring bases shown with the two options of DIN clip mounting.

SCANNER WIRING

SCANNER WIRING FOR MBUVS-301D, 311D (Must use 45UV5-1007, -08, -09 scanner)

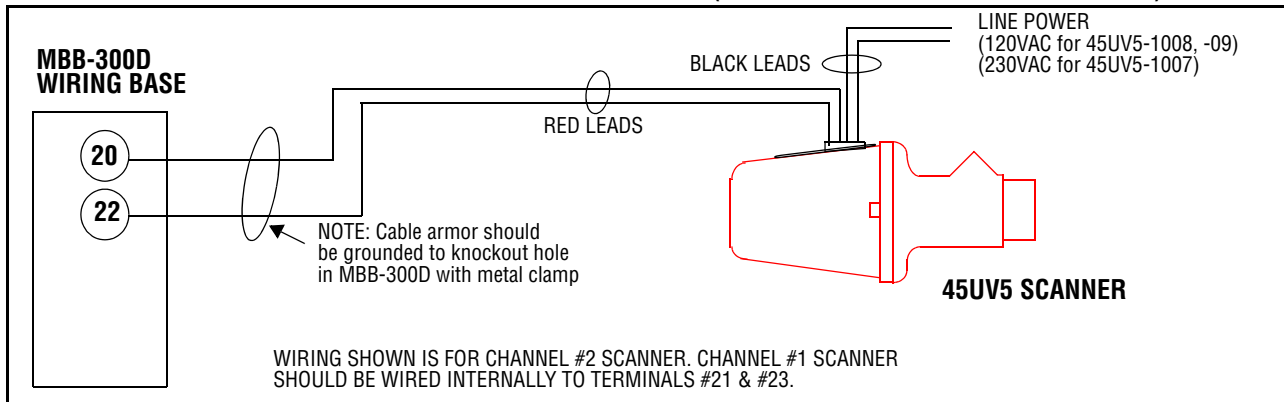

APPLICATION WIRING NOTES

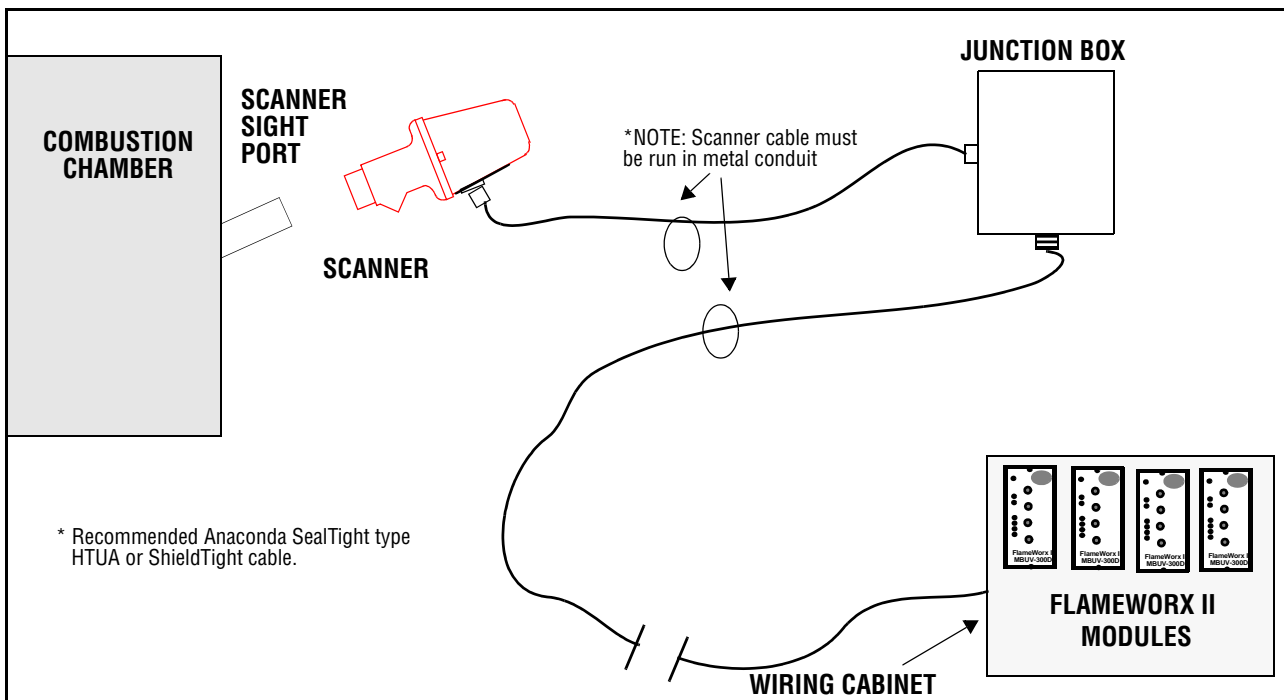

SCANNER WIRING NOTES:

The FlameWorx II system is built to protect against various types of electrical interference. The flame switch and the scanner each have a metal housing. To complete the system protection, the installation technician **MUST** fully enclose the scanner wires in a continuous outer conductor, which connects the flame switch's wiring base to the scanner housing.

Standard metal electrical conduit is a suitable outer conductor. Any continuous metal tubing such as rigid conduit or thinwall conduit (also called "electric metallic tubing") is extremely effective.

However, flexible conduit requires special attention. Many common types of flexible metal conduit are made of a spiral-wound metal strip, and not all such material makes a reliable electrical contact between neighboring turns. We recommend Anaconda "ShieldTight" flexible liquid-tight conduit for use with UV scanner wires. We have also found in lab tests that Anaconda type HTUA gave effective protection. Either of these types of EMI-resistant flex conduit uses the same fittings as ordinary liquid-tight conduit. The 45UV5 family of scanner has a 1/2" -14NPSM thread which accepts liquid-tight conduit fittings.

The UV1A family of scanners have a permanently attached 1/4" flexible metal conduit, which can be attached to a knockout in a wiring base or junction box using a metal Romex fitting.

It's essential that all joints in the outer conductor be assembled with the appropriate metal conduit fittings, to assure a continuous low-inductance conductive path. Metal junction boxes with metal covers and standard knockout fittings are used to connect one type of conduit to another.



WARNING: electrical safety codes in some jurisdictions require that scanner housings, or wiring bases, or both be grounded by bonding wires. A properly connected outer conductor will function correctly to suppress interference, regardless of grounding.



CAUTION: All scanner leads must be routed through the outer conductor all the way to the wiring base of the flame switch that receives the scanner signal.

Note that if the wiring base is mounted inside a control cabinet, the outer conductor must be carried without a discontinuity throughout the cabinet wall to the wiring base. Perhaps the simplest method is a short piece of appropriate flexible conduit inside the cabinet, with a female-threaded fitting replacing the locknut where the external conduit fitting is attached. Alternatively, the conduit wiring base could be grounded to the cabinet with a bonding wire to meet the requirements of local electrical codes.

FLAME SWITCH POWER WIRING INSTALLATION

The ground terminal of each low-voltage and high-voltage power supply must be connected to the metal housing of the wiring base or ground terminal inside. Use a short, heavy wire (18 AWG or larger).

EXAMPLE OF FLAME SCANNERS #1 AND #2 TO BE USED WITH MBUVS MODELS

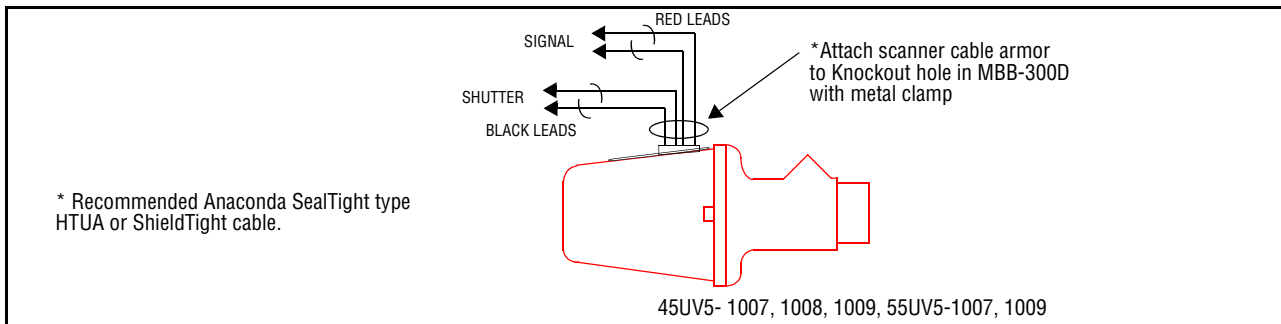

MODEL	MOUNTING THREADS	SHUTTER CYCLE PERIOD	BLACK LEADS SHUTTER	RED LEADS SIGNAL
45UV5-1007 55UV5-1007	1" BSP	0.4 Seconds Closed 3.6 Seconds Open	230 VAC	560 VAC from Control
45UV5-1008	1" BSP	0.4 Seconds Closed 3.6 Seconds Open	120 VAC	560 VAC from Control
45UV5-1009 55UV5-1009	1" NPT	0.4 Seconds Closed 3.6 Seconds Open	120 VAC	560 VAC from Control

UV SCANNER OUTLINE DIMENSIONS

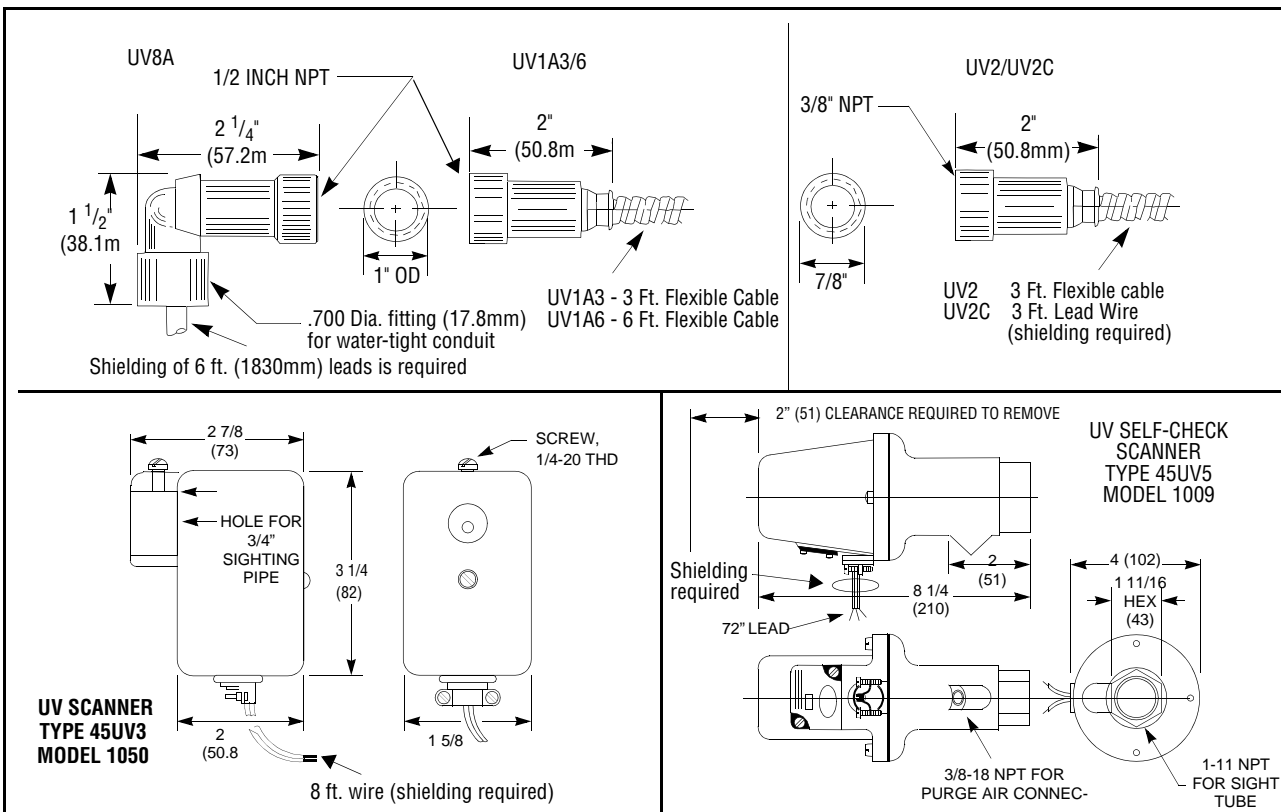

WARNING: The leads from the UV1A, UV8A and UV2C Scanners to the control must be shielded to prevent electrical noise from generating a false flame signal to the control.

WIRING DIAGRAMS AND TYPICAL SYSTEM



WARNING: A continuous outer conductor between scanner housing and wiring base is mandatory

WIRING INFORMATION – WIRING BASE MBB-300D

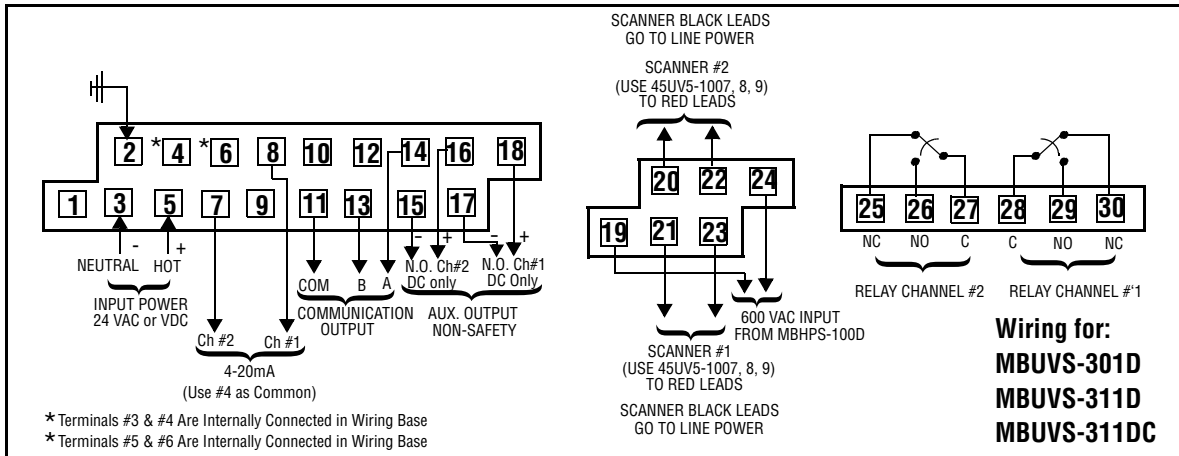
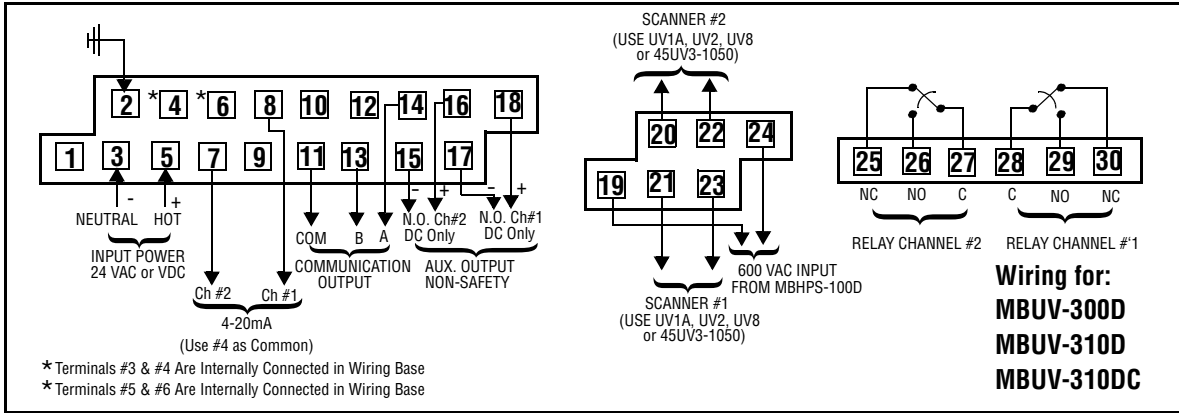

CAUTION: When using the wiring knock-out holes, make sure that the proper installation hardware is used to avoid allowing any objects to be inserted into the holes where they may become in contact with live power.



WARNING: You **MUST** use the same phase AC line voltage on both output relays and you **MUST NOT** power one relay with AC and the other with DC.

CONVERSION INSTRUCTIONS TO REPLACE A FIREYE MBUV-100D OR MBUVS-100D WITH A FLAMEWORX II

Description

When converting a Fireye MBUV or MBUVS-100D to a new MBUV or MBUVS-300 Series product, you **MUST REPLACE** and **REWIRE** the wiring subbase. Follow the instructions shown below.



CAUTION: This conversion should be performed by a qualified service technician of electrician. Please contact your local Fireye distributor or representative to identify a local service contractor.

Replacement Instructions

1. Disconnect all power to installation.
2. Remove the existing MBUV or MBUVS-100D from its wiring sub-base by loosening the screws found on the top and bottom of the module.
3. Remove and tag all wires with the terminal number that it was connected to on the 60-2537 sub-base.
4. Remove the sub-base from its mounting location. If the installation uses DIN Rail Mounting, you will have to install the two DIN clips on the new MBB-300D wiring base. The clips and mounting screws are in the wiring base packaging. If DIN mounting is not used, you will have to mount the new base using holes found in the bottom surface.

NOTE: The width of the new module is identical to the MBUV & MBUVS-100D. The height and weight are slightly larger.

5. Wire the new module using the following location diagram. If there was no wire connected to a particular terminal on the original sub-base, do not be concerned about filling the new terminals.

MBUV/MBUVS-100D		MBUV/MBUVS-300D SERIES
Terminal #1	Connect to ↓	Terminal #19
Terminal #2	Connect to ↓	Terminal #24
Terminal #3	Connect to ↓	Terminal #21
Terminal #4	Connect to ↓	Terminal #23
Terminal #5	Connect to ↓	Terminal #20
Terminal #6	Connect to ↓	Terminal #22
Terminal #7	Connect to ↓	Terminal #29
Terminal #8	Connect to ↓	Terminal #28
Terminal #9*	Connect to ↓	Terminal #30
Terminal #10**	Connect to ↓	Terminal #25
Terminal #11	Connect to ↓	Terminal #27
Terminal #12	Connect to ↓	Terminal #26
Terminal #13	Connect to ↓	Terminal #5
Terminal #14	Connect to ↓	Terminal #3

* If the Jumper Plug JP4 is connected to positions 1&2 on the board, then a remote 4-20mA meter is being used. Connect the wire removed from Terminal #9 on the 60-2537 sub-base to Terminal # 8 on the new MBB-300D sub-base.

** If the Jumper Plug JP5 is connected to positions 1&2 on the board, then a remote 4-20mA meter is being used. Connect the wire removed from Terminal #10 on the 60-2537 sub-base to Terminal #7 on the new MBB-300D sub-base. **The new FlameWorx II product provides more features than were found on the previous version. Check the technical bulletin to identify all of the functions and proper wiring.**



CAUTION: Be sure to install an earth ground to Terminal #2 on the MBB-300D



NOTICE

When Fireeye products are combined with equipment manufactured by others and/or integrated into systems designed or manufactured by others, the Fireeye warranty, as stated in its General Terms and Conditions of Sale, pertains only to the Fireeye products and not to any other equipment or to the combined system or its overall performance.

WARRANTIES

FIREYE guarantees for *one year from the date of installation or 18 months from date of manufacture* of its products to replace, or, at its option, to repair any product or part thereof (except lamps, electronic tubes and photocells) which is found defective in material or workmanship or which otherwise fails to conform to the description of the product on the face of its sales order. **THE FOREGOING IS IN LIEU OF ALL OTHER WARRANTIES AND FIREYE MAKES NO WARRANTY OF MERCHANTABILITY OR ANY OTHER WARRANTY, EXPRESS OR IMPLIED.** Except as specifically stated in these general terms and conditions of sale, remedies with respect to any product or part number manufactured or sold by Fireeye shall be limited exclusively to the right to replacement or repair as above provided. In no event shall Fireeye be liable for consequential or special damages of any nature that may arise in connection with such product or part.



The content on or accessible through CombustionDepot.com, (*including, but not limited to*) text, graphics and other materials, are provided by CombustionDepot.com, for informational purposes only. CombustionDepot.com does not claim ownership to any of the photos, images, or pictures of products on the site. These depictions are solely for information purposes and may not be an exact replication of the related product available for sale. All PDF and specification pages are gathered from the OEM web sites or publicly available information. CombustionDepot.com does not claim responsibility for any of the information found on these bulletins, documents, literature, specification charts, etc. and such information is subject to change without notice.